

AT THE
FRENT

HARKEN®

2020

© Bruce Kohorn



© Mike Schrage

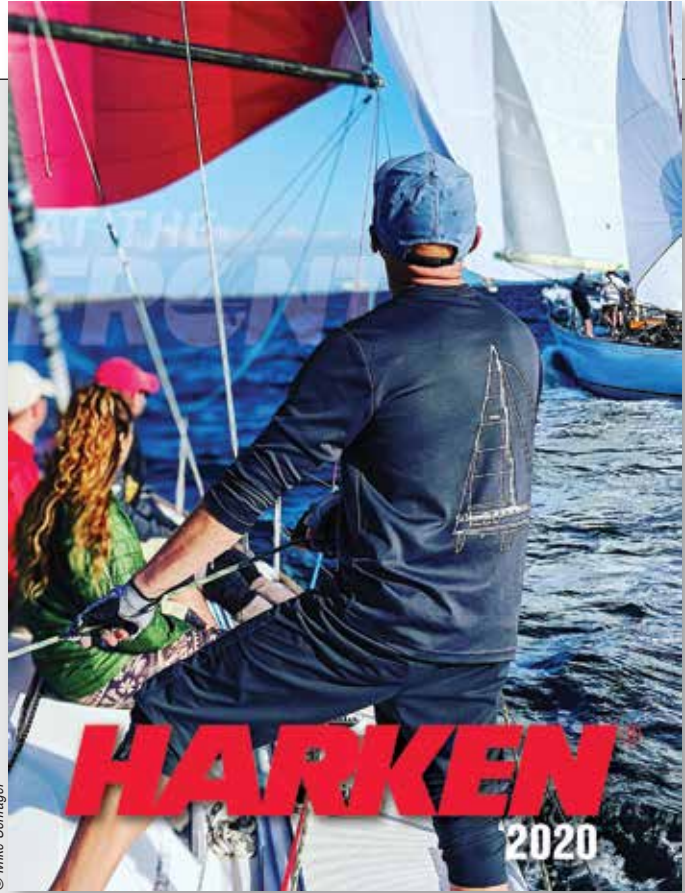

© Justin Edelmann



© Craig Pirniski

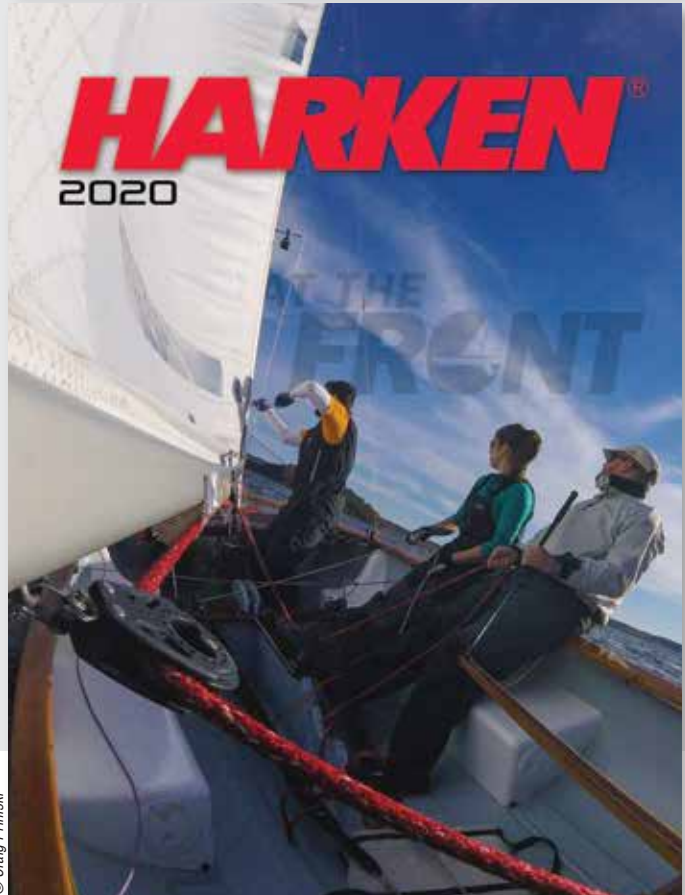

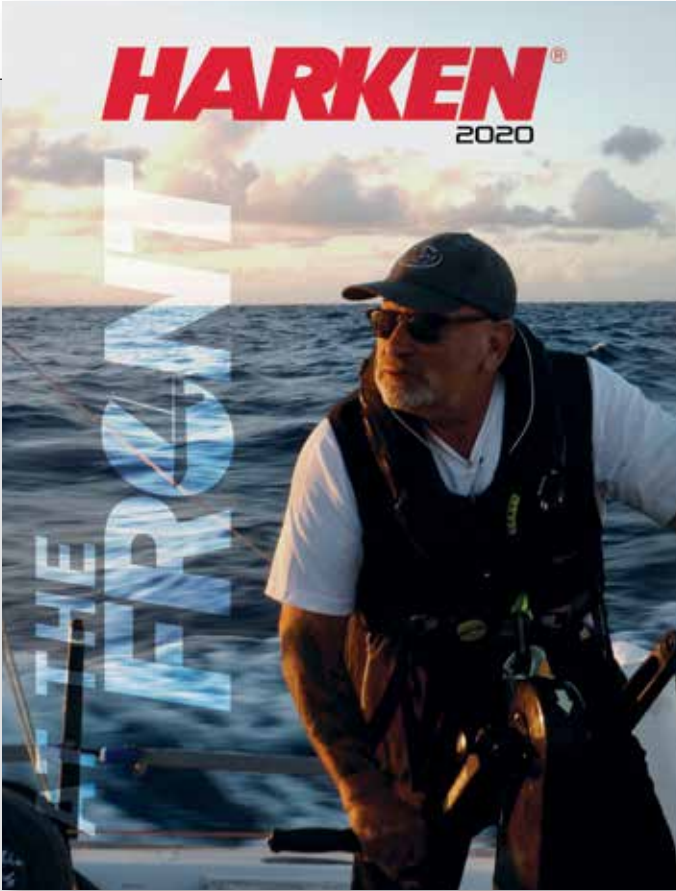

© Lisa Stuart

For several years we've been using the theme line AT THE FRONT. In the beginning, those words were written to make a commitment: Harken products will exceed the challenges of the biggest moments in our sport. Over time, we've learned a little more about those moments. They don't always lead to the podium.

This year we launched a photo contest in the USA, designed so customers could show us images of their AT THE FRONT sailing moments. You can see several of the most compelling of those on the cover and on the adjacent page of this catalog. They're wonderful.

Looking at the submissions, we've come to better understand where to find THE FRONT. It's in the eye and in the heart of the beholder.

At Harken, we have something we call our Weather Mark. We rely on it to navigate the company. The third element demands that we, **"Service Your Customers Beyond Their Expectations."** We seek to do that every day. And we're always amazed when given the opportunity, how much our customers return the favor.

Here are all the Weather Mark elements.

- Keep the well-being of your people first.
- Make the best products at a fair price.
- Service your customers beyond their expectations.
- Never lose the basic judgment you've been taught: your sense of right from wrong.

Like any company, Harken evolves. Things change. The Weather Mark will not be one of those, ever.

Good Sailing,
The whole Harken team

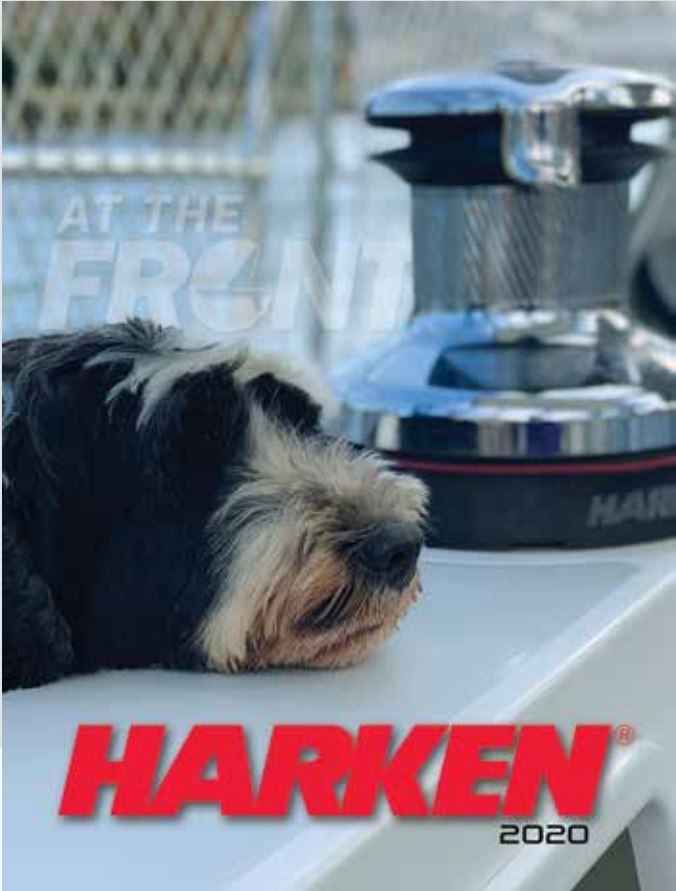

© Tadashi Arisaka



SMALL BOAT BLOCKS 18 - 44



BIG BOAT BLOCKS 45 - 67



COMPLEMENTARY HARDWARE 69 - 93



TRAVELERS & GENOA LEADS 94 - 131



MAINSAIL HANDLING SYSTEMS 132 - 154



HEADSAIL HANDLING SYSTEMS 155 - 190



WINCHES 191 - 228



HYDRAULICS 229 - 252



REFERENCE 255 - 279



INDEX 280 - 293

Catalog Guide

16 Materials & Properties

18 Small Boat Blocks

- Fly Blocks
- Carbo Air Blocks
 - T2/T2 Ratchamatic
 - 29 mm
 - 40 mm
 - 57 mm
 - 75 mm
- HTE Ratchamatic/Power3 Ratchet
- Ratchet
- Ratchamatic
- Fiddle

Small Boat Flip-Flops/Dinghy Vang

Protexit Exit Blocks

- 16 mm
- Micro
- Classic Blocks
 - Bullet
 - Dinghy
 - 2.25"
 - Hexa-Cat Bases

GP Catamaran Ceramic Mainsheet System

Two-Speed Mainsheet Systems

Midrange/Midrange Hexaratchet

Wire

45 Big Boat Blocks

- Element Blocks
 - 45 mm
 - 60 mm
 - 80 mm
- Black Magic Air Blocks
 - 57 mm
 - 75 mm
 - 100 mm
 - 125 mm/150 mm

Air Runner Blocks/Crossover

Teardrops/Footblocks

FlatWinder Powered Block

Stainless Cruising ESP

Megayacht Blocks

Mastbase Halyard Leads

Over-The-Top/Flip Flop

High-Load Snatch

V Blocks

69 Complementary Hardware

- Cam Cleats/Accessories
- Cam Bases
- Stand-Up Bases
- Accessories
- Self-Contained Sheaves
- Big Boat Sheaves
- V Sheaves
- High-Load/Narrow/Steering Sheaves

40 & 50 mm Deck Organizers

Big Boat Deck Organizers

Spinnaker Pole Cars

Soft Attachments

Stainless Steel Shackles

Eyestraps

Folding Padeyes/Padeyes

Fixed & Removable Padeyes

Lead Rings

GP Jib Leads/
Bolt-Down Fairleads

Halyard Tensioners/Tiller Extension

94 Travelers & Genoa Leads

Dinghy Pinstop Jib Leads

Crossbow Pivoting Self-Tacking
Jib Traveler System

CB Captive Ball Bearing Travelers &
Genoa Lead Cars

13 mm Micro

22 mm Small Boat

27 mm Midrange

32 mm Big Boat

Windward Sheeting

CRX Roller

42 mm Mini-Maxi

64 mm Maxi

Curved Track

T-Track Genoa Lead Cars

Access Rail System

132 Mainsail Handling Systems

Battcar Systems

T-Track Switch Battcar Systems

Trysail Switch

Furling Mainsail/Outhaul Systems/
Lazy Jacks

155 Headsail Handling Systems

Carbo Racing Foil

Small Boat Furling Components

Reflex Furling

MKIV

MKIV Underdeck

ESP

Electric

MKIV Hydraulic

Accessories

191 Winches

SnubbAir

Radial

Aluminum

Chrome

White

Bronze

Powered

Electric & Hydraulic Motors

Unipower

Rewind

Performa

Electric & Hydraulic

Electric Components

Digital System Switch

CLR Mooring Winches

Aluminum

Stainless Steel

Bronze

Carbon Fiber

Pedestals

Pedestal Drive Components

Handles

Service Kits

Electric & Hydraulic Captive Reel

229 Hydraulics

Integral Backstay Adjuster

Cylinders

Locking Cylinders

Double-pull Cylinders

Cylinder Blocks & Toggles

Boom Vangs

Grand Prix Cylinders

Valves & Manifolds

MVP-1 & MVP-4 Control Panels

Compact Control Panels/Pump Handles

Pumps

Rotary Pumps

Reservoirs

Accessories

Power Systems

254 McLube® Products

255 Reference

Warranty/Warnings

Trademarks

Maintenance

Genoa Lead Car

Traveler

Mainsheet

Boom Vang

Outhaul

Cunningham

Mastbase & Cabin Top

Spinnaker

Spinnaker Pole Handling

Backstay Adjuster

Mainsail Reefing

Self-Tacking Jibs/Staysail

Metric Conversions/Drilling Guide

Ball Bearing Replacement Chart

Rigging Breaking Loads

Loading Formulas

280 Index

McLube is a registered trademark of McGee Industries, Inc.

© Harken, Inc. 2019. All rights reserved. No portion of this catalog may be reproduced without the express written permission of Harken, Inc. Printed in U.S.A.



Jean Martins

Grand Prix & Tech Service Manager

Harkenite Since 1987

In his more than 32 years with Harken, Jean Martins

has been key in Harken's collaboration with the legends in the world of French offshore racing – more than 50 is his conservative count. They include the giants who created the Vendee Globe race, its first winner, its first two-time winner and multiple winners of the Route du Rhum and the Transat Jacques Vabre.

As technical service manager at Harken France, Jean is responsible for creating layout specifications and assembling price quotes for custom racing projects at the highest performance levels of our sport.

“I like staying at the front of research and development in order to offer our customers the most advanced products – which they should expect,” he says. “I also like watching the impressive evolution of their boats. It's great to feel even a small part of what those sailors accomplish.”

Away from office, Jean likes to play tennis, hike, bike, and sail.



Harken Materials & Properties

Aluminum

6061-T6: an aluminum alloy that has excellent corrosion resistance to air and salt water. It is an easily welded, tough alloy that responds well to anodizing.

7075-T6: the strongest aluminum alloy with strength comparable to many steels. Harken uses 7075-T6 in its Grand Prix cylinders which are built to handle extremely high loads at minimal weight. A vigorous maintenance schedule is required when using this alloy, because corrosion resistance is lower than 6061-T6. Available in hardcoat or clear-anodized finishes.

Bearings

Bearing properties are functions of contact area, material type, bearing cages, and whether the bearing rolls or slides.

Types

Ball bearings: very low-friction; low/medium-load capacity.

Roller bearings: low-friction; high-load capacity.

Sleeve bearings: medium/high-friction; extremely high-load capacity.

Materials

Stainless steel is stronger than Torlon® thermoplastic and Torlon is stronger than Delrin® acetal resin. Because stainless is heavier and usually higher maintenance, Torlon is used in most high-load applications.

Contact Area

More contact between the bearing and the race increases friction, but also increases load capacity. Balls are loaded on small points, cylindrical rollers are loaded along their length, and sleeve bearings are curved around the shaft so a large portion is in contact. Unlike balls and cylinders, sleeves are not prone to being flattened by extreme or static loads because they already conform to the curvature of the shaft.

Motion (rolling, caged rolling, or sliding)

Sliding bearings (known as sleeve, plain, full-contact, bushing, or journal bearings) are very high strength, but have nothing to reduce friction between contact areas. At most, they have a low-friction sleeve between the surfaces. Rollers and balls avoid almost all of this friction because they do not slide against the race, though they can come in contact with each other. Caged roller bearings are separated from each other to avoid this.

Caged Bearings

Caged bearings are roller bearings held in a cage that keeps them separated from each other and parallel to reduce friction. Caged bearings are used in winches and Black Magic blocks.

Captive Bearings

Captive bearings are ball bearings that are contained so they won't spill during product maintenance. Black Magic blocks have ball bearings held captive by the lip of the sheave. CB traveler cars feature ball bearings held captive by a wire guide.

Carbo

Carbo Air blocks feature lightweight, fiber-reinforced, nylon-resin sideplates with a 60% higher MWL than stainless-reinforced Classic blocks. Lightweight fiber-reinforced Carbo-Cams are ideal for racing where weight is critical. The Carbo name comes from an additive that gives blocks their color and UV-resistance.

Carbon Black

Carbon black is a color additive used in black Delrin ball bearings, block sheaves, and sideplates to protect against UV exposure.

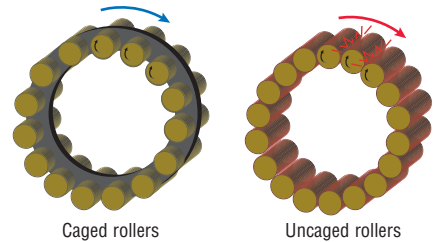
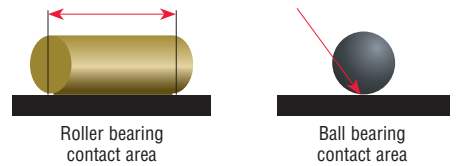
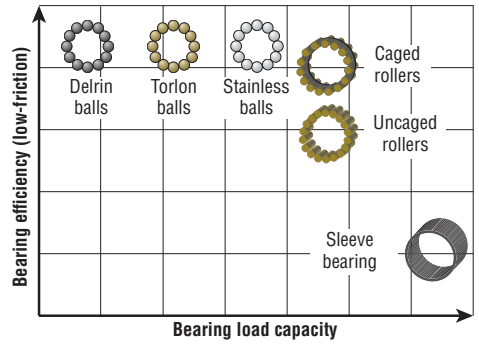

For complete listing, see www.harken.com/glossary

Delrin is a registered trademark of E. I. du Pont de Nemours and Company or its affiliates.
Torlon is a registered trademark of Solvay Advanced Polymers, L.L.C.

Harken Materials & Properties

Clear-Anodized

Clear aluminum anodizing is an electrochemical process that produces a corrosion-resistant finish. It also hardens the surface, making components less prone to scratches and dents. It is “clear” because the protective layer isn’t thick enough to change the color of the component (though dye can be added). More rigorous anodizing, such as hardcoat, can give components a black or colored hue.

Delrin® Acetal Resin

Black (white in older blocks) material which excels in small boat and low to moderate-load applications. Delrin® acetal resin is used for bearings, sheaves, and sideplates.

Hardcoat-Anodized

Hardcoat aluminum anodizing is an electrochemical process that produces a corrosion-resistant finish with hardness characteristics second only to diamonds. Harken’s hardcoating process is twice as thick as black anodizing to provide extra protection against scratches, dents, superficial deformation, and corrosion.

Hard Lube-Anodized

Hard Lube-anodized aluminum includes all the corrosion-resistant properties of hardcoat-anodized aluminum with the additional benefits of a PTFE coating for a smoother surface and reduced friction.

Nylatron® Nylon

Durable, lightweight composite material that has high mechanical strength and stiffness, resists static electricity, and has excellent wear resistance.

PTFE-Coated

PTFE-coating, along with anodizing, protects aluminum against corrosion by sealing the surface from moisture. It also minimizes friction and gives the component better wear resistance.

Stainless Steel

17-4 PH Stainless Steel: this alloy is used in gears because it is hardenable to extremely high strengths. 17-4 PH is more corrosion-resistant than any other standard hardenable stainless steel.

316 Stainless Steel: this is a nonhardenable alloy with high corrosion resistance in freshwater and saltwater.

XM-19 Stainless Steel: this stainless is highly alloyed, with very high mechanical strength and superior corrosion resistance. Rods and pins in Harken cylinders are made of XM-19 stainless.

Titanium

This lightweight, hard metal has the highest strength-to-weight ratio of any metal. Its corrosion rate is so low that after 4000 years in seawater, corrosion would only have penetrated to the thickness of a thin sheet of paper. Harken uses titanium rollers in V blocks to handle bearing loads.

Torlon® Thermoplastic

Exceptionally strong crush/impact-resistant bearing material that withstands heavy long-term use and shock loading. Most Harken hardware that sees extreme loads uses greenish-brown Torlon® bearings.

UV-Stabilized

UV light photo-degrades composites by breaking their chemical bonds, leaving them weak, brittle, and discolored. This is common in equipment with white bearings. All Harken composites and bearings are naturally UV-resistant or use stabilizers like carbon black.



6061-T6 Aluminum Anodizing Thickness

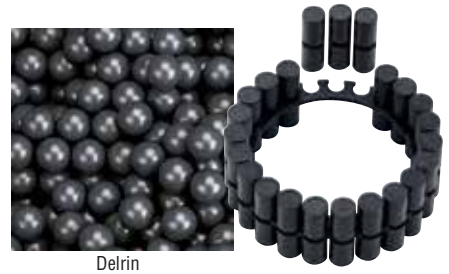
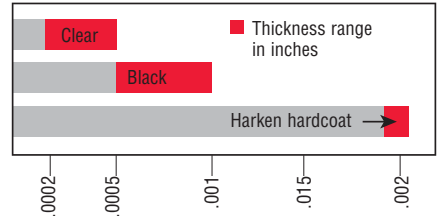

Delrin



Torlon



Not UV-stabilized

UV-stabilized

For complete listing, see www.harken.com/glossary

Delrin is a registered trademark of E. I. du Pont de Nemours and Company or its affiliates.

Nylatron is a registered trademark of Quadrant EPP USA Inc.

Torlon is a registered trademark of Solvay Advanced Polymers, L.L.C.

SMALL BOAT BLOCKS

NEW FOR 2020



**75 mm Power3
ratchets**
Page 27



**Dinghy
vang**
Page 33



Fly Blocks

Harken soft-attach Fly blocks are designed to provide strength without mass, providing sailors with big power in a low-aero package. Designed specifically for high-tech line, these efficient blocks have an incredible working load for their small size. Fly blocks are perfect for use on foiling dinghies and sportboats and for vang cascades and backstay systems on Grand-Prix racers.

18 mm

18 mm blocks feature an integrated stainless steel inner race and rivet, stainless steel ball bearings, and composite fiber-reinforced sideplates.

29 & 40 mm

29 and 40 mm blocks feature a one-piece titanium outer race/sheave, stainless steel ball bearings and inner race, and composite fiber-reinforced sideplates.



Fly Blocks



Use the 2161 "tight cinching" 18 mm in applications where the block needs to be secured extremely close to the deck.



2161



2698



2158



2171



2173

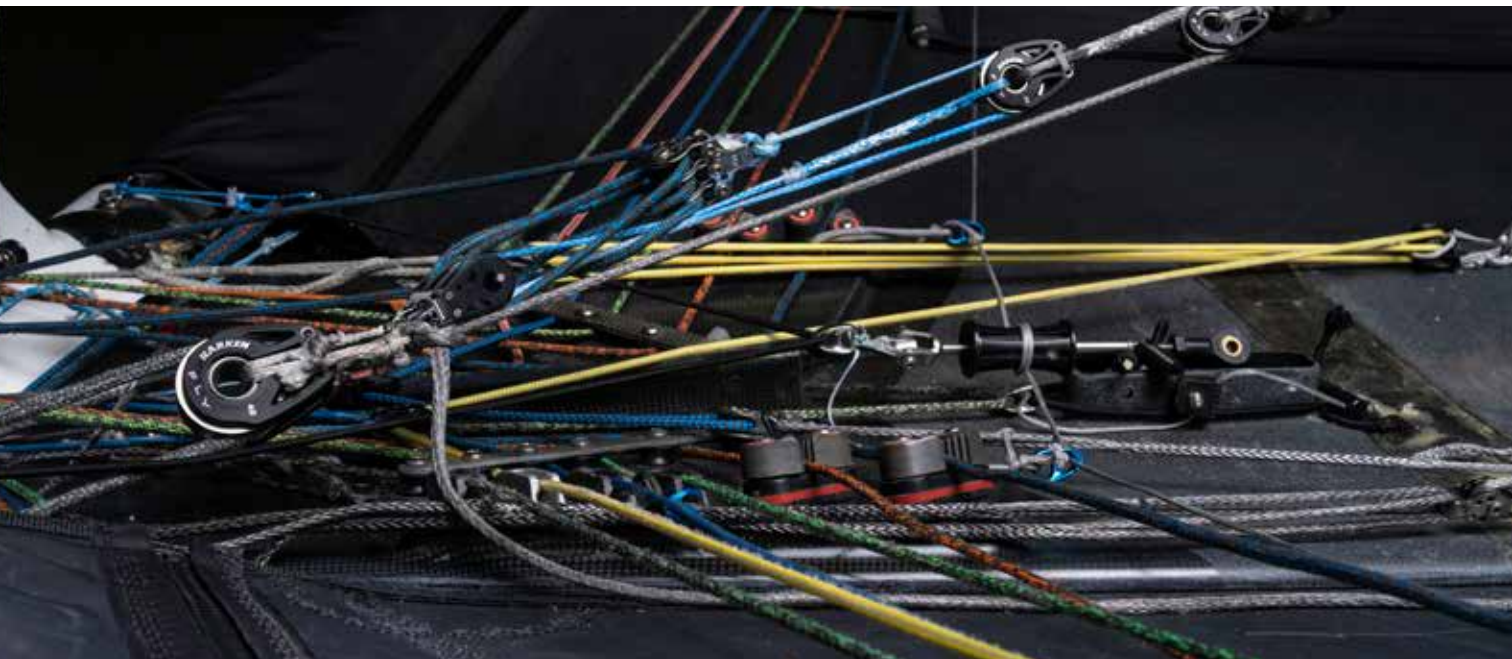

Part No.	Description	Sheave Ø		Length		Weight		Max line Ø		Maximum working load		Breaking load	
		in	mm	in	mm	oz	g	in	mm	lb	kg	lb	kg
2158	18 mm double	23/32	18	1 3/32	28	.6	17	3/16	5	450	204	1500	680
2161	18 mm single/narrow	23/32	18	1 3/32	28	.25	7.2	3/16	5	275	125	992	450
2171	29 mm single*	1 1/8	29	1 3/4	44	.92	26	9/32	7	770	350	1540	700
2173	40 mm single*	1 9/16	40	2 5/16	58	2.2	62.2	11/32	9	1435	650	2870	1300
2698	18 mm single	23/32	18	1 3/32	28	.25	7.2	3/16	5	275	125	992	450

*Lashing line not included.



© Mari Johnson

CARBO AIR BLOCKS

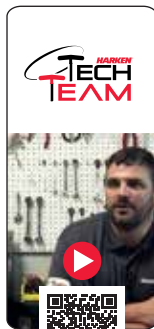

Which Block Do I Need?

These smooth-running powerful performers make trimming easy, no matter how hard the wind blows. Carbo Air blocks are made of tough reinforced composite in a size and style to fit any system: singles, doubles, triples, quads, and quints; ratchets and fiddles; soft and hard attach; 18 - 75 mm. Perfect for main, jib and spinnaker sheets on dinghies and sportboats; control lines on boats of all sizes.

High-strength, lightweight

- Lightweight, strong and reliable fiber-reinforced composite construction.
- Open Air block design eliminates unnecessary material to reduce weight.

Stands up to sun, salt, and time

- Ball bearings, sheave, and sideplates are UV-stabilized.

Low-friction efficiency for fast trim and release

- Free-running ball bearings roll on curved races, efficiently dispersing load for a higher strength block.



Cam-Lock



U-Lock

Shackle blocks lock in two directions or swivel to keep line from twisting

- Cam-Lock or U-Lock allows shackle to be fixed or to swivel.

Materials

For properties see pages 16-17.

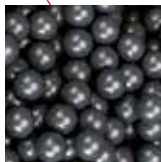

Delrin®
acetal resin,
UV-stabilized:
Ball bearings



Carbo composite:
Sideplates, sheave

DO NOT use Harken equipment for human suspension unless product is specifically certified and labeled for such use.

Delrin is a registered trademark of E. I. du Pont de Nemours and Company or its affiliates.

Carbo T2 Soft-Attach Blocks

Harken offers these patented, high-strength, soft-attach blocks in 29 to 57 mm sizes. They feature composite sheaves that spin freely on Delrin® ball bearings with curved bearing races. They have no metal shackles or rivets, making them the lightest soft-attach blocks Harken has ever designed.

All T2 blocks are lashed or spliced through the load-bearing center of the block, decreasing the loads on the sideplates and acting as a safety backup for the system.

T2 Blocks

T2 blocks come in single and double configurations and can be tied, spliced, or lashed to almost anything. T2 doubles feature composite line guides that are integrated into the block head. They keep the block aligned correctly by pushing the lashing line to the outer edges of the block's head.

T2 Loop Blocks

The T2 Loop block's on/off loop system slides through the block head and over the anchor post for a secure connection. A SK75 Dyneema® loop is included. Replacement loops available.

T2 Ratchamatic Blocks

The patented T2 Ratchamatic is Harken's newest block to feature the T2 line's styling and soft-attachment system. Pressure on the line engages the ratchet mechanism, which switches seamlessly from free-running to ratchet mode. Unloaded main and jib sheets run out freely during mark roundings, and asymmetrical spinnaker sheets free instantly during jibes.

The weight of this high-strength block is only a few ounces. This is thanks to composite fiber-reinforced sideplates, hardcoat-anodized aluminum sheave, a lightweight soft-attach, and a minimum of moving parts in the ratcheting mechanism.

A length of Spectra® line with a polyester cover is included.



T2 block with open center
Line ties, splices, or lashes to almost anything: cascades, bridles, traveler controls.



T2 Loop block with anchor post
Loops deadend on anchor post for easy installation. No knots or splices needed. Slide the loop through the head and over the anchor post for a secure connection.



T2 Ratchamatic block
Blocks are clearly labeled with high-contrast directional markers for correct reeving and trimming direction.



57 mm T2 Ratchamatic blocks are also available with Power3 sheaves which offer holding power options suitable for a variety of wind conditions. Contact Harken for more information.



Delrin is a registered trademark of E. I. du Pont de Nemours and Company or its affiliates.
Dyneema is a registered trademark of DSM IP Assets B.V. L.L.C.
Spectra is a registered trademark of Honeywell International, Inc.

Part No.	Description	Sheave Ø		Length		Weight		Max line Ø		Maximum working load		Breaking load	
		in	mm	in	mm	oz	g	in	mm	lb	kg	lb	kg
T2													
2146	Single	1 1/8	29	1 11/16	43	.4	12	5/16	8	330	150	1000	454
2147	Double	1 1/8	29	1 11/16	43	.83	23.5	5/16	8	600	272	1900	861
2149	Single	1 9/16	40	2 1/4	57	.9	25	3/8	10	485	220	1200	544
2150	Double	1 9/16	40	2 1/4	57	1.7	48	3/8	10	700	317	2100	952
2152	Single	2 1/4	57	3 1/16	79	2	57	7/16	11	792	359	2380	1080
2153	Double	2 1/4	57	3 1/16	79	3.8	107.5	7/16	11	1080	490	3200	1451
2162	Traveler	1 9/16	40	3 15/32	88	1.4	39	3/16	5	275	125	992	450
T2 Loop													
2148	Single*	1 9/16	40	2 1/4	57	.92	26	3/8	10	485	220	1200	544
2151	Single**	2 1/4	57	3 1/16	79	2	59	7/16	11	792	359	2380	1080
T2 Ratchamatic													
2159	Single	1 9/16	40	2 1/4	57	.9	25	3/8	10	300	136	1000	454
2160 / .RED	Single	2 1/4	57	3 1/16	79	2.5	71	3/8	10	500	227	2000	907

*Includes 2154 loop. **Includes 2155 loop. Replacement loops see page 85.



29 mm Blocks

About Carbo Air blocks: see feature page at beginning of this section.



340



341



342



343



344



345



346



347



348



349



350



371



381



352



Doubles and triples feature U-Locks to hold the swivel in front/side position, or to let it spin freely.



Use as becket block without the additional height of a becket.

30 mm (1 3/16")
32 mm (1 1/4")



353



395



396



High-strength pivoting lead blocks with cams are used for halyard controls on larger keelboats and as "headknockers" on dinghies and beachcats for sheeting directly from the boom. Hole spacing and rivet size are the same as Classic models, making upgrades easy. Cam reverses for either up or down cleating.

Part No.	Description	Sheave Ø		Length		Weight		Shackle pin Ø		Max line Ø		Maximum working load		Breaking load	
		in	mm	in	mm	oz	g	in	mm	in	mm	lb	kg	lb	kg
340	Single/swivel	1 1/8	29	2 5/8	66	.9	26	5/32	4	5/16	8	330	150	1000	454
341	Single/swivel/becket	1 1/8	29	3 1/16	78	1	28	5/32	4	5/16	8	330	150	1000	454
342	Double/swivel	1 1/8	29	2 7/8	73	1.8	51	3/16	5	5/16	8	660	299	1625	737
343	Double/swivel/becket	1 1/8	29	3 3/8	85	1.9	54	3/16	5	5/16	8	660	299	1625	737
344	Triple/swivel	1 1/8	29	2 7/8	73	2.6	74	3/16	5	5/16	8	990	449	2000	907
345	Triple/swivel/becket	1 1/8	29	3 3/8	85	2.7	77	3/16	5	5/16	8	990	449	2000	907
346	Triple/471 Carbo-Cam**	1 1/8	29	2 7/8	73	4.6	130	3/16	5	1/4	6	750	340	1500	680
347	Triple/471 Carbo-Cam/becket**	1 1/8	29	3 3/8	85	4.7	133	3/16	5	1/4	6	900	408	1800	816
348	Single/fixed*	1 1/8	29	1 15/16	49	.8	23			5/16	8	330	150	1000	454
349	Stand-up/fixed*	1 1/8	29	2 3/16	56	1.1	31			5/16	8	330	150	1000	454
350	Cheek	1 1/8	29	2 1/8	53	.6	17			5/16	8	330	150	1000	454
352	90° fixed head*	1 1/8	29	2 1/16	52	.9	26			5/16	8	330	150	1000	454
353	Traveler	1 1/8	29	3 5/8	92	1.2	34			5/16	8	330	150	1000	454
371	Clew block assembly	1 1/8	29	4 7/8	124	1.8	51			5/16	8	330	150	1000	454
381	Double/fixed	1 1/8	29	2 1/8	54	1.2	34			5/16	8	660	299	1625	737
395	Pivoting lead block/468 Cam-Matic**	1 1/8	29	3 15/16	100	3.2	90.7			1/4	6	200	91	650	295
396	Pivoting lead block/471 Carbo-Cam**	1 1/8	29	3 15/16	100	2.96	83.7			1/4	6	150	68	650	295

*Can be used as becket block. **Maximum working loads and breaking loads for blocks based on cam strengths.

40 mm Blocks

About Carbo Air blocks: see feature page at beginning of this section.



2646



Reversible cam arms.



Use as becket block without the additional height of a becket.

Melges 14, 4.27 m (14'), Reichel/Pugh design, Melges © Mari Johnson

2644

2163



2636

2637

2649

2650

2652

2659



2645



32 mm (1 1/4")



Part No.	Description	Sheave Ø		Length		Weight		Shackle pin Ø		Max line Ø		Maximum working load		Breaking load	
		in	mm	in	mm	oz	g	in	mm	in	mm	lb	kg	lb	kg
2163	Cheek/becket	1 9/16	40	2 29/32	74	4.9	139			3/8	10	485	220	1620	735
2636	Single/swivel	1 9/16	40	3 3/8	86	1.6	44	5/32	4	3/8	10	485	220	1620	735
2637	Single/swivel/becket	1 9/16	40	4	102	1.7	48	5/32	4	3/8	10	485	220	1620	735
2644	Cheek	1 9/16	40	2 3/4	70	1.2	34			3/8	10	485	220	1620	735
2645	Single/swivel/471 Carbo-Cam**	1 9/16	40	3 3/8	86	4.2	119	5/32	4	1/4	6	150	68	300	136
2646	Single/swivel/471 Carbo-Cam/becket**	1 9/16	40	4	102	4.3	122	5/32	4	1/4	6	300	136	600	272
2649	Traveler	1 9/16	40	4 1/4	108	1.8	52			5/16	8	330	150	1000	454
2650	Single/stand-up/fixed*	1 9/16	40	2 1/2	64	1.4	40			3/8	10	485	220	1620	735
2652	Stand-up/fixed*	1 9/16	40	2 3/4	70	1.7	48			3/8	10	485	220	1620	735
2659	90° fixed head*	1 9/16	40	2 15/16	75	1.6	44			3/8	10	485	220	1620	735

*Can be used as becket block. **Maximum working loads and breaking loads for blocks based on cam strengths.



40 mm Blocks

About Carbo Air blocks: see feature page at beginning of this section.

Tiwal 2, 2.79 m (9'2"), naval architect: Marion Excoffon © Tiwal



2156



2157

High-strength pivoting lead blocks with cams are used for halyard controls on larger keelboats and as "headknockers" on dinghies and beachcats for sheeting directly from the boom. Hole spacing and rivet size are the same as Classic models, making upgrades easy. Cam reverses for either up or down cleating.



2638



2639



2640



2641



2642



2643



2647



2648



2654

Part No.	Description	Sheave Ø		Length		Weight		Shackle pin Ø		Max line Ø		Maximum working load		Breaking load	
		in	mm	in	mm	oz	g	in	mm	in	mm	lb	kg	lb	kg
2156	Pivoting lead block/150 Cam-Matic* **	1 9/16	40	4 1/2	112	6.6	186			3/8	10	300	136	950	430
2157	Pivoting lead block/365 Carbo-Cam* **	1 9/16	40	4 1/2	112	5.5	157			3/8	10	200	91	950	430
2638	Double/swivel	1 9/16	40	3 11/16	94	3.2	86	3/16	5	3/8	10	970	440	2380	1080
2639	Double/swivel/becket	1 9/16	40	4 5/16	110	3.4	90	3/16	5	3/8	10	970	440	2380	1080
2640	Triple/swivel	1 9/16	40	3 11/16	94	4.6	118	3/16	5	3/8	10	1455	660	3050	1383
2641	Triple/swivel/becket	1 9/16	40	4 5/16	110	4.7	122	3/16	5	3/8	10	1455	660	3050	1383
2642	Double/fixed	1 9/16	40	3 1/2	89	2.8	80	3/16	5	3/8	10	970	440	2380	1080
2643	Double/fixed/becket	1 9/16	40	4 3/16	106	2.9	84	3/16	5	3/8	10	970	440	2380	1080
2647	Triple/swivel/471 Carbo-Cam**	1 9/16	40	3 11/16	94	8.2	232	3/16	5	1/4	6	750	340	1500	680
2648	Triple/swivel/471 Carbo-Cam/becket**	1 9/16	40	4 5/16	110	8.3	235	3/16	5	1/4	6	900	408	1800	816
2654	Quad/swivel	1 9/16	40	3 11/16	94	6	170	3/16	5	3/8	10	1455	660	3050	1383

*Can be used as becket block. **Maximum working loads and breaking loads for blocks based on cam strengths.

57 mm Blocks

About Carbo Air blocks: see feature page at beginning of this section.



Part No.	Description	Sheave Ø		Length		Weight		Shackle pin Ø		Max line Ø		Maximum working load		Breaking load	
		in	mm	in	mm	oz	g	in	mm	in	mm	lb	kg	lb	kg
2600	Single/swivel	2 1/4	57	4 5/16	110	3.1	87	3/16	5	3/8	10	792	359	2380	1079
2601	Single/swivel/becket	2 1/4	57	5 3/16	132	3.4	96	3/16	5	3/8	10	792	359	2380	1079
2602	Double/swivel	2 1/4	57	4 3/4	121	6.3	178	1/4	6	3/8	10	1584	720	3300	1500
2603	Double/swivel/becket	2 1/4	57	5 5/8	142	6.6	187	1/4	6	3/8	10	1584	720	3300	1500
2604	Triple/swivel	2 1/4	57	4 3/4	121	9	255	1/4	6	3/8	10	2380	1080	5000	2270
2605	Triple/swivel/becket	2 1/4	57	5 5/8	142	9.3	264	1/4	6	3/8	10	2380	1080	5000	2270
2606	Cheek	2 1/4	57	3 5/8	92	2.4	68			3/8	10	792	359	2380	1079
2615	Single/swivel/150 Cam-Matic*	2 1/4	57	4 5/16	110	9.5	269	3/16	5	3/8	10	300	136	750	340
2616	Single/swivel/150 Cam-Matic/becket*	2 1/4	57	5 3/16	132	15.6	442	3/16	5	3/8	10	600	272	1500	680
2617	Triple/swivel/150 Cam-Matic*	2 1/4	57	4 3/4	121	15.2	431	1/4	6	3/8	10	1500	680	3750	1700
2618	Triple/swivel/150 Cam-Matic/becket*	2 1/4	57	5 5/8	142	15.6	442	1/4	6	3/8	10	1800	816	4500	2040
2631	Quadruple/swivel	2 1/4	57	4 3/4	121	12	340	1/4	6	3/8	10	2380	1080	5000	2270
2762	5-sheave/swivel	2 1/4	57	4 3/4	121	15.8	448	1/4	6	3/8	10	2380	1080	5000	2270

*Maximum working loads and breaking loads for blocks based on cam strengths.



75 mm Blocks

About Carbo Air blocks: see feature page at beginning of this section.



2661



Saffier Sc 6.5m Cruise, 6.50 m (21.3'), Dean Hennevanger design © Bertel Kolthof / Saffier Yachts

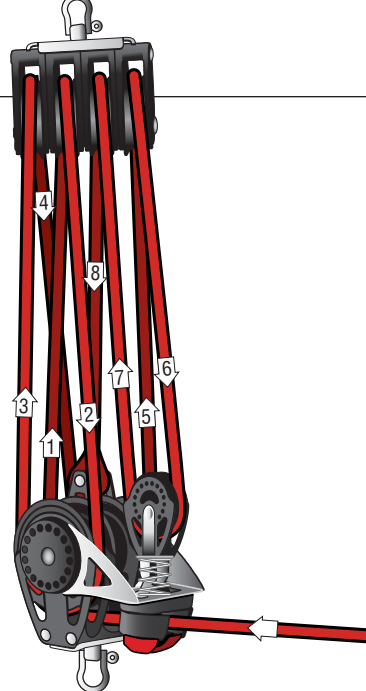

Use with 2687 for a powerful 8:1 purchase.



Part No.	Description	Sheave Ø		Length		Weight		Shackle pin Ø		Max line Ø		Maximum working load		Breaking load	
		in	mm	in	mm	oz	g	in	mm	in	mm	lb	kg	lb	kg
2660	Single/swivel	2 15/16	75	5 3/8	137	6.9	195	1/4	6	9/16	14	1213	550	3638	1650
2661	Single/swivel/becket	2 15/16	75	6 1/2	165	7.5	214	1/4	6	9/16	14	1213	550	3638	1650
2662	Double/swivel	2 15/16	75	6	152	14.2	402	5/16	8	9/16	14	2426	1100	6000	2722
2663	Double/swivel/becket	2 15/16	75	7	178	14.8	419	5/16	8	9/16	14	2426	1100	6000	2722
2664	Triple/swivel	2 15/16	75	6	152	20.5	580	5/16	8	9/16	14	3639	1650	10000	4535
2665	Triple/swivel/becket	2 15/16	75	7	178	21.1	599	5/16	8	9/16	14	3639	1650	10000	4535
2666	Single/swivel/150 Cam-Matic*	2 15/16	75	5 3/8	137	13.4	381	1/4	6	1/2	12	300	136	750	340
2667	Single/swivel/150 Cam-Matic/becket*	2 15/16	75	6 1/2	165	14	397	1/4	6	1/2	12	600	272	1500	680
2668	Triple/swivel/150 Cam-Matic*	2 15/16	75	6	152	27.8	788	5/16	8	1/2	12	1500	680	3750	1700
2669	Triple/swivel/150 Cam-Matic/becket*	2 15/16	75	7	178	28.4	805	5/16	8	1/2	12	1800	816	4500	2040
2677	Quadruple/swivel	2 15/16	75	6 1/4	159	27.2	772	5/16	8	9/16	14	3639	1650	10000	4535

*Maximum working loads and breaking loads for blocks based on cam strengths.

Ratchamatic HTE Blocks

The spring on the HTE (high-threshold engage) version of the 57 mm Carbo Ratchamatic blocks was made stiffer to delay the point where the ratchet engages, allowing the block to run free more of the time. The ratchet function engages at higher loads to allow the old kite sheet to run free for crisper gybes.



Ratchet vs
Ratchamatic



Pressure on the line engages the ratchet mechanism, which switches seamlessly from free-running to ratchet mode.

Part No.	Description	Sheave Ø		Length		Weight		Shackle pin Ø		Max line Ø		Maximum working load		Breaking load		Holding power*
		in	mm	in	mm	oz	g	in	mm	in	mm	lb	kg	lb	kg	
2625.HTE	Single/swivel/standard grip	2 1/4	57	4 1/16	103	3.7	104	3/16	5	3/8	10	500	227	2000	907	10:1
2165.HTE	Single/swivel/1.5x grip	2 1/4	57	4 1/16	103	3.7	104	3/16	5	3/8	10	500	227	2000	907	15:1
2168.HTE	Single/swivel/2x grip	2 1/4	57	4 1/16	103	3.7	104	3/16	5	3/8	10	500	227	2000	907	20:1

*Measured with 180° wrap.

Power3 Ratchet Blocks

Power3 ratchet blocks provide sailors that race small one-designs with three holding-power options to handle a variety of wind and sea conditions. More choices allow sailors to fine-tune their set-ups in tandem with the purchase that provides the ideal level of power, responsiveness and grip.

Standard grip: medium/light air

1.5x grip: breeze-on/puffs

2x grip: big breeze/steady



Standard grip:
black

1.5x grip:
titanium

2x grip:
silver



Part No.	Description	Sheave Ø		Length		Weight		Shackle pin Ø		Max line Ø		Maximum working load		Breaking load		Holding power*
		in	mm	in	mm	oz	g	in	mm	in	mm	lb	kg	lb	kg	
Switchable Ratchets																
2135	Single/swivel/standard grip	2 1/4	57	4 1/16	103	3	85	3/16	5	3/8	10	500	227	2000	907	10:1
2166	Single/swivel/1.5x grip	2 1/4	57	4 1/16	103	3	85	3/16	5	3/8	10	500	227	2000	907	15:1
2169	Single/swivel/2x grip	2 1/4	57	4 1/16	103	3	85	3/16	5	3/8	10	500	227	2000	907	20:1
2172	57 mm two-pack/1.5x & 2x grip	2 1/4	57													
2670	Single/swivel/standard grip	2 15/16	75	5 3/8	137	8	227	1/4	6	7/16	12	750	341	3000	1361	15:1
2174	Single/swivel/1.5x grip	2 15/16	75	5 3/8	137	8	227	1/4	6	7/16	12	750	341	3000	1361	22:1
2176	Single/swivel/2x grip	2 15/16	75	5 3/8	137	8	227	1/4	6	7/16	12	750	341	3000	1361	30:1
Ratchamatic																
2625	Single/swivel/standard grip	2 1/4	57	4 1/16	103	3.7	104	3/16	5	3/8	10	500	227	2000	907	10:1
2165	Single/swivel/1.5x grip	2 1/4	57	4 1/16	103	3.7	104	3/16	5	3/8	10	500	227	2000	907	15:1
2168	Single/swivel/2x grip	2 1/4	57	4 1/16	103	3.7	104	3/16	5	3/8	10	500	227	2000	907	20:1
2680	Single/swivel/standard grip	2 15/16	75	5 3/8	137	8.4	238	1/4	6	7/16	12	750	341	3000	1361	15:1
2175	Single/swivel/1.5x grip	2 15/16	75	5 3/8	137	8.4	238	1/4	6	7/16	12	750	341	3000	1361	22:1
2177	Single/swivel/2x grip	2 15/16	75	5 3/8	137	8.4	238	1/4	6	7/16	12	750	341	3000	1361	30:1
T2 Soft-Attach Ratchamatic																
2160	Single/standard grip	2 1/4	57	3 1/16	79	2.5	71			3/8	10	500	227	2000	907	10:1
2167	Single/1.5x grip	2 1/4	57	3 1/16	79	2.5	71			3/8	10	500	227	2000	907	15:1
2170	Single/2x grip	2 1/4	57	3 1/16	79	2.5	71			3/8	10	500	227	2000	907	20:1

*Measured with 180° wrap.



Ratchet Blocks

Carbo ratchet blocks allow sailors to hand-hold loaded lines and offer balance between holding power and controlled easing.

Nylon-resin sideplates are densely packed with long-glass fibers for a compact block with a high strength-to-weight ratio. Machined aluminum sheaves are Hard Lube-anodized for strength and corrosion resistance. Eight facets hold line securely. Ball bearings, sheave, and sideplates are UV-stabilized with carbon black for maximum protection.

40 mm

The 40 mm ratchets are ideal for jib sheets and spinnakers where size and weight are critical. The 2608, 2609, and 2614 have on/off switches; other 40 mm ratchets are always in ratchet mode.

57 mm and 75 mm

The 57 mm and 75 mm switchable ratchets provide precise control with an accessible on/off switch that is easy-to-operate from both sides of the block.

For the ultimate system, mount a switchable ratchet in the cockpit and a boom-mounted Ratchamatic block directly above for double holding power in heavy air and a free-running mainsheet when it's light. The 75 mm provides up to 15:1 holding power; the 57 mm 10:1.

About Carbo Air blocks: see feature page at beginning of this section.



2135.RED

2608
2135
2670

2609
2136
2671



2614
2137
2672



2138

2139

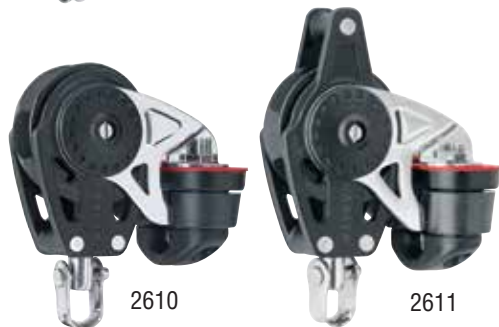

2610

2611



Ratchet or Ratchamatic?



On/off switch operates from both sides.



All 57 mm and 75 mm ratchet blocks are also available with Power3 sheaves which offer holding power options suitable for a variety of wind conditions. Contact Harken for more information.



Switch locks shackle in front or side positions, or lets block swivel to keep line from twisting.

Part No.	Description	Sheave Ø		Length		Weight		Shackle pin Ø		Max line Ø		Maximum working load		Breaking load	
		in	mm	in	mm	oz	g	in	mm	in	mm	lb	kg	lb	kg
40 mm															
2608	Single/swivel	1 9/16	40	3 3/8	86	1.7	49	5/32	4	3/8	10	300	136	1000	454
2609	Single/swivel/becket	1 9/16	40	4	102	1.8	52	5/32	4	3/8	10	300	136	1000	454
2610	Single/swivel/471 Carbo-Cam**	1 9/16	40	3 3/8	86	4.6	129	5/32	4	1/4	6	150	68	300	136
2611	Single/swivel/471 Carbo-Cam/becket**	1 9/16	40	4	102	4.7	132	5/32	4	1/4	6	300	136	600	272
2614	Cheek*	1 9/16	40	2 3/4	70	1.6	44			3/8	10	300	136	1000	454
57 mm															
2135 / .RED	Single/swivel	2 1/4	57	4 1/16	103	3	85	3/16	5	3/8	10	500	227	2000	907
2136	Single/swivel/becket	2 1/4	57	4 15/16	125	3.3	94	3/16	5	3/8	10	500	227	2000	907
2137	Cheek*	2 1/4	57	3 1/4	83	2.5	71			3/8	10	500	227	2000	907
2138	Single/swivel/150 Cam-Matic**	2 1/4	57	4 1/16	103	8.7	247	3/16	5	3/8	10	300	136	750	340
2139	Single/swivel/150 Cam-Matic/becket**	2 1/4	57	4 15/16	125	9	255	3/16	5	3/8	10	600	272	1500	680
75 mm															
2670	Single/swivel	2 15/16	75	5 3/8	137	8	227	1/4	6	7/16	12	750	341	3000	1361
2671	Single/swivel/becket	2 15/16	75	6 1/2	165	8.75	248	1/4	6	7/16	12	750	341	3000	1361
2672	Cheek*	2 15/16	75	4 1/16	103	6.3	179			7/16	12	750	341	3000	1361

*Includes RH fasteners and mounting pad. **Maximum working loads and breaking loads for blocks based on cam strengths.

Ratchet Blocks

About Carbo Air blocks: see feature page at beginning of this section.



Cam assembly adjusts and locks in a range of positions for crew accessibility.



© Michael Lechner

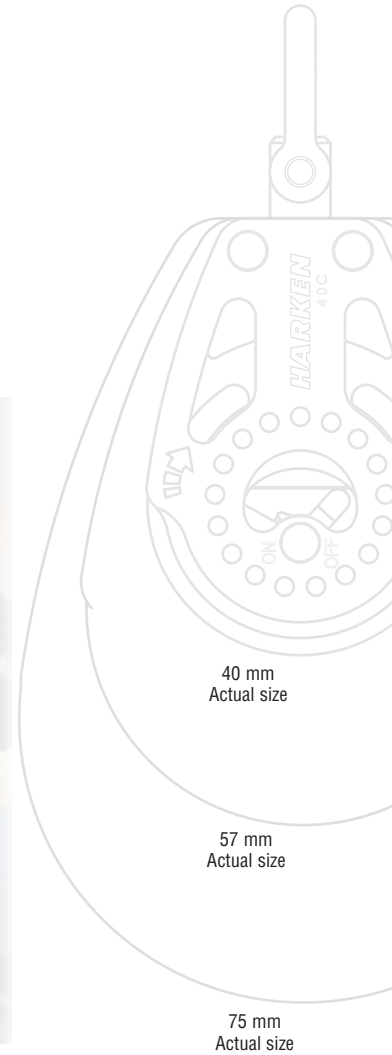

Part No.	Description	Sheave Ø		Length		Weight		Shackle pin Ø		Max line Ø		Maximum working load		Breaking load	
		in	mm	in	mm	oz	g	in	mm	in	mm	lb	kg	lb	kg
40 mm															
2612	Triple/swivel/471 Carbo-Cam*	1 9/16	40	3 11/16	94	8.5	242	1/4	6	3/16	5	750	340	1500	680
2613	Triple/swivel/471 Carbo-Cam/becket*	1 9/16	40	4 5/16	110	8.6	245	1/4	6	3/16	5	900	408	1800	816
2619	Triple/471 Carbo-Cam/29 mm block/becket*	1 9/16	40	4 3/4	121	9.5	269	1/4	6	3/16	5	900	408	1800	816
57 mm															
2140	Triple/swivel/150 Cam-Matic*	2 1/4	57	4 1/16	103	15.4	435	1/4	6	3/8	10	1500	680	3750	1700
2141	Triple/swivel/150 Cam-Matic/becket*	2 1/4	57	4 15/16	125	15.7	445	1/4	6	3/8	10	1800	816	4500	2041

*Maximum working loads and breaking loads for blocks based on cam strengths.



Ratchamatic Blocks

The Carbo Ratchamatic is a load-sensing ratchet block that rolls freely in both directions under low loads and automatically engages the ratchet as loads increase. Shifting between ratchet and light-air modes is seamless. Unloaded main and jib sheets run out freely during mark roundings and asymmetrical spinnakers free instantly during jibes.

Ratchet engagement may be adjusted to a higher or lower load according to strength and sailing style. The Ratchamatic cheek block mounts on either port or starboard. The holding power of the 57 mm is as high as 10:1. The 75 mm is up to 15:1.

For the ultimate system, mount a Ratchamatic block on the boom above a cockpit-mounted switchable ratchet to allow the mainsheet to run freely in light air and to double holding power in heavy air.

Use the 2634 with a 402 or 403 swivel arm for a versatile two-speed mainsheet system.

About Carbo Air blocks: see feature page at beginning of this section.



DN iceboat © Marcella Grunert



2625.RED

2625
2680



2628
2684



2626
2681



2627
2683



2633
2682



Adjustable ratchet engagement adapts block to a variety of applications.



Eight-faceted, Hard Lube-anodized aluminum sheave holds line securely.



All 57 mm and 75 mm Ratchamatic blocks are also available with Power3 sheaves which offer holding power options suitable for a variety of wind conditions. In addition, all 57 mm Ratchamatic blocks can be made with HTE (high threshold engage) sheaves to delay ratchet engagement, allowing them to run freely more of the time. Contact Harken for more information.

Part No.	Description	Sheave Ø		Length		Weight		Shackle pin Ø		Max line Ø		Maximum working load		Breaking load		Holding power w/180° wrap 50 lb (23 kg)
		in	mm	in	mm	oz	g	in	mm	in	mm	lb	kg	lb	kg	
57 mm																
2625 / .RED	Single	2 1/4	57	4 1/16	103	3.7	104	3/16	5	3/8	10	500	227	2000	907	10:1
2626	Single/becket	2 1/4	57	4 15/16	125	4	113	3/16	5	3/8	10	500	227	2000	907	10:1
2627	Single/150 Cam-Matic**	2 1/4	57	4 1/16	103	9.4	266	3/16	5	3/8	10	300	136	750	340	10:1
2628	Single/150 Cam-Matic/becket**	2 1/4	57	4 15/16	125	9.7	275	3/16	5	3/8	10	600	272	1500	680	10:1
2633	Cheek*	2 1/4	57	3 1/4	83	3.1	89			3/8	10	500	227	2000	907	10:1
75 mm																
2680	Single	2 15/16	75	5 3/8	137	8.4	238	1/4	6	7/16	12	750	341	3000	1361	15:1
2681	Single/becket	2 15/16	75	6 1/2	165	9	255	1/4	6	7/16	12	750	341	3000	1361	15:1
2682	Cheek*	2 15/16	75	4 1/16	103	6.5	184			7/16	12	750	341	3000	1361	15:1
2683	Single/150 Cam-Matic**	2 15/16	75	5 7/16	138	15.5	440	1/4	6	7/16	12	300	136	750	340	15:1
2684	Single/150 Cam-Matic/becket**	2 15/16	75	6 1/2	165	15.5	440	1/4	6	7/16	12	600	272	1500	680	15:1

*Includes RH fasteners and mounting pad. **Maximum working loads and breaking loads for blocks based on cam strengths.

Ratchamatic Blocks

About Carbo Air blocks: see feature page at beginning of this section.



DNA F1 A-Cat, Mischa Heemskerk, 5.49 m, DNA Performance Yachts © DNA Performance Sailing



Use with 2631/2677 for a powerful 8:1 purchase.

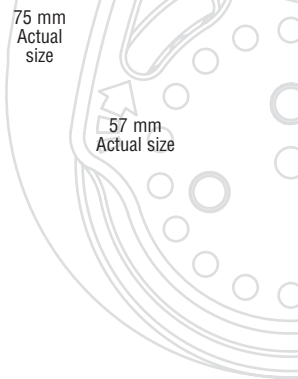

Part No.	Description	Sheave Ø		Length		Weight		Shackle pin Ø		Max line Ø		Maximum working load		Breaking load		Holding power w/180° wrap 50 lb (23 kg)
		in	mm	in	mm	oz	g	in	mm	in	mm	lb	kg	lb	kg	
57 mm																
2629	Triple/150 Cam-Matic*	2 1/4	57	4 1/16	103	14.9	421	1/4	6	3/8	10	1500	680	3750	1700	10:1
2630	Triple/150 Cam-Matic/becket*	2 1/4	57	4 15/16	125	15.2	431	1/4	6	3/8	10	1800	816	4500	2041	10:1
2632	Triple/150 Cam-Matic/40 mm block/becket*	2 1/4	57	6 1/8	156	18.3	520	1/4	6	3/8	10	1800	816	4500	2041	10:1
2634	Double	2 1/4	57	4 9/16	116	7.2	204	1/4	6	3/8	10	750	340	1875	851	10:1
75 mm																
2685	Triple/150 Cam-Matic*	2 15/16	75	6 3/16	137	31	879	5/16	8	7/16	12	1500	680	3750	1700	15:1
2686	Triple/150 Cam-Matic/becket*	2 15/16	75	6 1/2	165	31.6	896	5/16	8	7/16	12	1800	816	4500	2041	15:1
2687	Triple/150 Cam-Matic/57 mm block/becket*	2 15/16	75	6 1/2	165	34.7	984	5/16	8	7/16	12	1800	816	4500	2041	15:1

*Maximum working loads and breaking loads for blocks based on cam strengths.



Carbo Fiddle Blocks

The Carbo fiddle block line features high-load ball bearings with fitted races for low-friction operation. The 40 mm fiddle is an excellent choice for 3:1 and 4:1 tackles on dinghy vang and mainsheets, as well as for controls such as cunninghams and internal boom outhauls on larger boats.

The 57 mm fiddle features the Cam-Lock locking system. The switch allows the shackle to lock at 90-degree intervals or to swivel freely.

Ratchet Blocks

The 57 and 75 mm switchable ratchet blocks provide precise on/off control with accessible, easy-to-operate on/off switches on both sides of the block.

About Carbo Air blocks: see feature page at beginning of this section.



All 57 mm and 75 mm ratchet blocks are also available with Power3 sheaves which offer holding power options suitable for a variety of wind conditions. Contact Harken for more information.



Part No.	Description	Sheave Ø		Length		Weight		Shackle pin Ø		Max line Ø		Maximum working load		Breaking load	
		in	mm	in	mm	oz	g	in	mm	in	mm	lb	kg	lb	kg
40 mm															
2655	40 mm	1 9/16	40	4 1/2	115	1.8	51	5/32	4	3/8	10	485	220	1620	735
2656	40 mm/becket	1 9/16	40	5 1/8	131	1.9	54	5/32	4	3/8	10	485	220	1620	735
2657	40 mm/471 Carbo-Cam*	1 9/16	40	4 1/2	115	4.4	125	5/32	4	1/4	6	450	204	1500	680
2658	40 mm/471 Carbo-Cam/becket	1 9/16	40	5 1/8	131	4.5	128	5/32	4	1/4	6	485	220	1620	735
57 mm															
2621	57 mm	2 1/4	57	6	153	3.7	105	3/16	5	3/8	10	792	359	2380	1080
2622	57 mm/becket	2 1/4	57	6 7/8	175	4	113	3/16	5	3/8	10	792	359	2380	1080
2623	57 mm/150 Cam-Matic	2 1/4	57	6	153	10.1	286	3/16	5	3/8	10	792	359	2380	1080
2624	57 mm/150 Cam-Matic/becket	2 1/4	57	6 7/8	175	10.4	295	3/16	5	3/8	10	792	359	2380	1080
2673	57 mm/ratchet	2 1/4	57	4 5/8	118	4	113	3/16	5	3/8	10	792	359	2380	1080
2674	57 mm/ratchet/becket	2 1/4	57	5 5/8	143	4.3	121	3/16	5	3/8	10	792	359	2380	1080
2675	57 mm/ratchet/150 Cam-Matic	2 1/4	57	4 5/8	118	10.4	294	3/16	5	3/8	10	792	359	2380	1080
2676	57 mm/ratchet/150 Cam-Matic/becket	2 1/4	57	5 5/8	143	10.7	303	3/16	5	3/8	10	792	359	2380	1080
75 mm															
2690	75 mm	2 15/16	75	6 3/16	157	8.4	238	1/4	6	9/16	14	1212	550	3637	1650
2691	75 mm/becket	2 15/16	75	7 7/16	189	9.1	257	1/4	6	9/16	14	1212	550	3637	1650
2692	75 mm/150 Cam-Matic*	2 15/16	75	6 3/16	157	15	424	1/4	6	1/2	12	900	408	2250	1020
2693	75 mm/150 Cam-Matic/becket	2 15/16	75	7 7/16	189	15.6	443	1/4	6	1/2	12	1212	550	3637	1650
2694	75 mm/ratchet	2 15/16	75	6 3/16	157	9.5	270	1/4	6	1/2	12	1212	550	3637	1650
2695	75 mm/ratchet/becket	2 15/16	75	7 7/16	189	10.2	289	1/4	6	1/2	12	1212	550	3637	1650
2696	75 mm/ratchet/150 Cam-Matic*	2 15/16	75	6 3/16	157	16.1	456	1/4	6	1/2	12	900	408	2250	1020
2697	75 mm/ratchet/150 Cam-Matic/becket	2 15/16	75	7 7/16	189	16.8	475	1/4	6	1/2	12	1212	550	3637	1650

*Maximum working loads and breaking loads for blocks based on cam strengths.

Small Boat 57 & 75 mm Flip-Flop Blocks

Small Boat Flip-Flop blocks pivot around the line axis to keep line close to the deck. Hinged construction allows a variety of lead angles.

Lightweight, machined 6061-T6 aluminum cheeks pivot on fiber-reinforced plastic chocks. Sheave runs exclusively on a ball bearing system for fast trim and release under any load. Ball bearings, sheave, and sideplates are UV-stabilized with carbon black for maximum protection.

Ratchamatic block versions roll freely in both directions under low loads and automatically engage a ratchet mechanism as loads increase, giving sailors a holding power of up to 15:1. The ratchet engagement can be adjusted to a higher or lower load depending on the sailor's strength, sailing style and system usage.

Reversible cam arms adjust and lock in a range of positions for crew accessibility and accommodation of changing lead angles.



Block pivots around the line axis to keep line entry height low.



All 57 mm and 75 mm Ratchamatic blocks are also available with Power3 sheaves which offer holding power options suitable for a variety of wind conditions. In addition, all 57 mm Ratchamatic blocks can be made with HTE (high threshold engagement) sheaves to delay ratchet engagement, allowing them to run freely more of the time. Contact Harken for more information.

Part No.	Description	Sheave Ø		Width		Length		Height		Weight		Max line Ø		Maximum working load		Breaking load	
		in	mm	in	mm	in	mm	in	mm	oz	g	in	mm	lb	kg	lb	kg
2142	57 mm	2 1/4	57	2	50	4 5/16	110	2 1/8	54	5	141	3/8	10	500	227	1584	718
2143	57 mm/150 Cam-Matic*	2 1/4	57	2 5/8	66	4 5/16	110	4 5/16	110	11	304	3/8	10	300	136	600	272
2144	57 mm Ratchamatic	2 1/4	57	2	50	4 5/16	110	2 5/8	66	5.5	156	3/8	10	500	227	1000	554
2145	57 mm Ratchamatic/150 Cam-Matic*	2 1/4	57	2 5/8	66	4 5/16	110	4 3/16	106	12	329	3/8	10	300	136	600	272
2678	75 mm	3	75	2 1/2	64	5 5/8	143	3 3/4	95	9.7	275	9/16	14	750	340	2426	1100
2679	75 mm/150 Cam-Matic*	3	75	2 5/8	66	5 5/8	143	5 9/16	141	17	485	9/16	14	300	136	600	272
2688	75 mm Ratchamatic	3	75	2 1/2	64	5 5/8	143	3 1/2	89	11	304	7/16	12	750	340	1500	680
2689	75 mm Ratchamatic/150 Cam-Matic*	3	75	2 5/8	66	5 5/8	143	5 3/8	137	18	514	7/16	12	300	136	600	272

*Maximum working loads and breaking loads for blocks based on cam strengths.

Dinghy Vang

The dinghy vang features 16 mm sheaves with stainless ball bearing for high loads. The assembly includes a 468 Micro Cam-Matic® cleat that allows precise trimming. It's easy to cleat because it pivots for a fair lead. The unit connects to a mast bracket with a 1/4" pin. The system provides a 12:1 purchase when cascaded with 4:1 blocks. The vang lower unit is available by itself or as part of a kit, which includes a 16 mm double block cascaded to a Micro single with becket for the vang purchase, plus a Micro single for attaching the cunningham.



Part No.	Description	Weight		Max sail area		Maximum working load		Breaking load	
		oz	g	ft²	m²	lb	kg	lb	kg
431	Dinghy vang kit	10.3	291	125	11.6	400	181	1000	454
HSB534	Dinghy vang lower unit*	8.1	229	125	11.6	400	181	1000	454

*Order your own line, 406, and 225 blocks to complete system.

HSB534



Protexit™ Blocks

When you race HARD, and you rip through as many hoists and douses as we do sailing W-L legs all the time, you should expect to start wearing through the sideplates of your halyard exit block right? Wrong! Thanks to Harken Protexit™ blocks, wear from side angle loading is not inevitable. Protexit's all-aluminum, wear-resistant housing carefully ushers line in and out no matter the angle. There's more: Protexit blocks offer higher working loads than any small boat exit blocks we've ever made. Protexit aluminum sheaves rotate on sleeve bearings with Delrin® sideload balls so they don't deform in extreme conditions, while reducing wear on the halyard, too.

Strong. Durable. Gentle. Protexit blocks protect the race results you work hard to achieve.



Blocks are clearly labeled with part number, line diameter, maximum working load, and directional arrows for line direction.

Delrin is a registered trademark of E. I. du Pont de Nemours and Company or its affiliates.



Melges 24 © Petey Crawford



Part No.	Description	Sheave Ø		Length		Weight		Max line Ø		Fasteners (FH)		Fastener spacing	A	B	Maximum working load		Breaking load	
		in	mm	in	mm	oz	g	in	mm	in	mm				mm	mm	lb	kg
1200	30 mm single	1 3/16	30	2 15/16	75	1.3	37	5/16	8	#10	5	57	18.2	45.7	550	250	1103	500
1201	30 mm double	1 3/16	30	3 13/16	97	2	57	5/16	8	#10	5	79	18.2	70.1	550	250	1103	500
1202	40 mm single	1 9/16	40	4 3/16	107	2.6	74	5/16	8	1/4	6	75	19.7	59.2	880	400	1764	800
1203	50 mm single	1 15/16	50	4 5/8	117	4.5	128	1/2	12	1/4	6	90	23.3	71.5	1760	800	3528	1600
1204	60 mm single	2 3/8	60	5 1/16	129	6.3	179	1/2	12	1/4	6	105	24.3	84	2640	1200	5292	2400

16 mm

The 16 mm is Harken's smallest block. It is perfect for small synthetic control lines found on high-tech dinghies.

The bearing system uses stainless steel balls in a captive grooved race and has a 113 kg (250 lb) maximum working load—the highest on the market compared to similarly sized blocks.

The 442 uses a spacer and the 404 uses an O-ring to keep the line in the sheave during intermittent loading.

The 467 and 484 use a narrow sheave for extremely small control lines and have a ferrule head for soft attachments. They use the same high load ball system. The 484 features a bronze sheave for added durability.

Use for:

Dinghy control lines	Spinnaker pole trip lines
Big Boat leech lines	Outhauls
Downhauls	Cunninghams
Traveler controls	Halyards on prams



Hardened stainless steel inner race for maximum strength-to-weight ratio.



Actual size

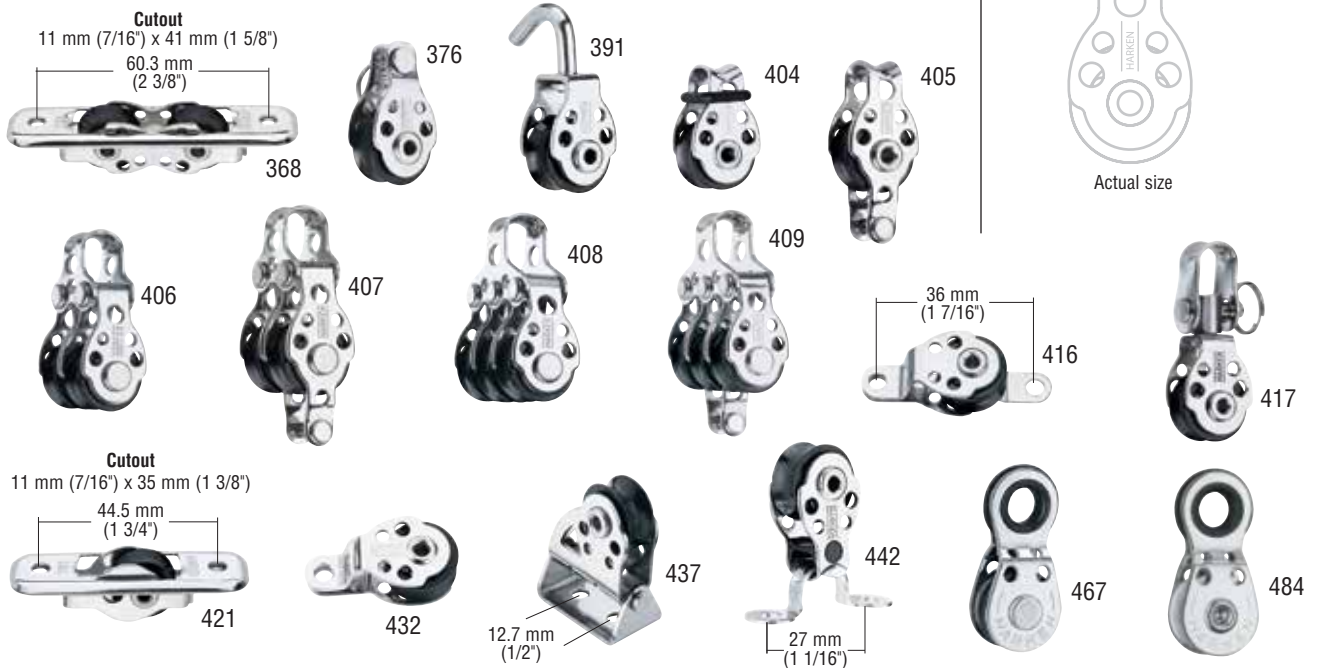

Part No.	Description	Sheave Ø		Length		Weight		Max line Ø		Maximum working load		Breaking load	
		in	mm	in	mm	oz	g	in	mm	lb	kg	lb	kg
368	In-line exit*	5/8	16	3	76	.94	27	7/32	5	250	113	1200	544
376	Forkhead	5/8	16	1 1/8	29	.38	11	7/32	5	250	113	1200	544
391	Hook-in halyard	5/8	16	1 5/8	41	.5	13	7/32	5	250	113	400	181
404	Single**	5/8	16	1 1/8	29	.33	10	7/32	5	250	113	1200	544
405	Single/becket	5/8	16	1 1/2	38	.44	12	7/32	5	250	113	1200	544
406	Double	5/8	16	1 11/16	43	.94	27	7/32	5	450	204	1200	544
407	Double/becket	5/8	16	2 1/8	54	1	28	7/32	5	450	204	1200	544
408	Triple	5/8	16	1 13/16	46	1.44	41	7/32	5	700	318	1200	544
409	Triple/becket	5/8	16	2 1/4	57	1.5	43	7/32	5	700	318	1200	544
416	Cheek*	5/8	16	1 13/16	46	.44	12	7/32	5	250	113	1200	544
417	Single/swivel***	5/8	16	1 13/16	46	.63	18	7/32	5	250	113	750	339
421	Through-deck*	5/8	16	2 3/8	60	.63	18	7/32	5	250	113	1200	544
432	Pivot cheek*	5/8	16	1 3/8	35	.38	11	7/32	5	250	113	750	339
437	Flip-flop*	5/8	16	1 5/16	34	.75	21	7/32	5	250	113	1200	544
442	Block/eyestrapp assembly*	5/8	16	1 3/8	35	.44	12	7/32	5	250	113	1200	544
467	Narrow ferrule head	5/8	16	1 15/32	37	.44	12	5/32	4	250	113	750	339
484	Narrow ferrule head, bronze sheave	5/8	16	1 15/32	37	.53	15	5/32	4	250	113	750	339

*4 mm (#8) RH fasteners. **Contact Harken for replacement O-rings HSB340. ***Shackle pin diameter 4 mm (5/32").



Micro Blocks

Low-friction Micro blocks are compact and lightweight. They are ideal for sailboards, smaller dinghies, and lightly loaded control lines on boats of all sizes.

Micro block sheaves run exclusively on ball bearing systems for fast trim and release under any load. Delrin® ball bearings are UV-stabilized with carbon black for maximum protection. Stainless steel sideplates add strength.

Use for:

- Cunninghams/outhauls
- Vangs
- Traveler controls
- Barberhaulers
- Flag halyards
- Leech cords
- Lead car return tackles



Micro fiddle with rounded V-Jam, or triples with cam make compact self-cleaning tackles.

Delrin is a registered trademark of E. I. du Pont de Nemours and Company or its affiliates.

Sheaves see page 78.

Part No.	Description	Sheave Ø		Length		Weight		Shackle pin Ø		Max line Ø		Maximum working load		Breaking load	
		in	mm	in	mm	oz	g	in	mm	in	mm	lb	kg	lb	kg
224	Single	7/8	22	1 1/2	38	.5	14			1/4	6	200	91	1200	544
225	Single/becket	7/8	22	2	51	.75	21			1/4	6	200	91	1200	544
226	Double	7/8	22	2	51	1.5	43			1/4	6	350	159	1200	544
227	Double/becket	7/8	22	2 1/2	64	1.5	43			1/4	6	350	159	1200	544
228	Triple	7/8	22	2	51	2	57			1/4	6	500	227	1200	544
229	Triple/becket	7/8	22	2 1/2	64	2.25	64			1/4	6	500	227	1200	544
230	Triple/471 Carbo-Cam	7/8	22	2	51	3.5	99			1/4	6	500	227	1200	544
231	Triple/471 Carbo-Cam/becket	7/8	22	2 1/2	64	3.5	99			1/4	6	500	227	1200	544
232	Traveler	7/8	22	2 3/4	71	1.25	35			1/4	6	200	91	1200	544
233	Cheek***	7/8	22	2 1/2	64	.75	21			1/4	6	200	91	1200	544
234	Single/shackle	7/8	22	2 1/4	57	.75	21	3/16	5	1/4	6	200	91	1200	544
235	Single/shackle/becket	7/8	22	2 3/4	71	1	28	3/16	5	1/4	6	200	91	1200	544
242	Through-deck***	7/8	22	2 5/8	67	1	28			1/4	6	200	91	1200	544
243	Upright***	7/8	22	1 1/2	38	1	28			1/4	6	200	91	1200	544
244	Fiddle/V-Jam*	7/8	22	3 1/2	89	2	57	3/16	5	1/4	6	350	159	1200	544
245	Fiddle/V-Jam/becket**	7/8	22	4	102	2	57	3/16	5	1/4	6	350	159	1200	544
292	Single/swivel	7/8	22	2 3/8	60	1	28	5/32	4	1/4	6	200	91	1200	544
377	Forkhead	7/8	22	1 21/32	42	.56	16			1/4	6	200	91	1200	544
443	Block/eyestrap assembly‡	7/8	22	1 3/4	45	.56	16			1/4	6	200	91	1000	454

*Use w/225 or 235. **Use w/226. ***#10 (5 mm) RH fasteners. ‡#8 (4 mm) RH fasteners.



Williwaw, Stuart Knockabout, 8.53 m (28'), Stuart Knockabout, LLC, naval architect: L. Francis Herreshoff © Tyler Field

CLASSIC BLOCKS

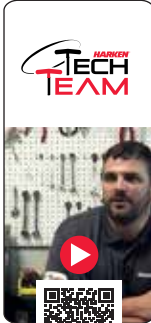

Which Block Do I Need?

The timeless styling of our Classic block line enhances your boat's traditional look. Strong, dependable and exceptionally free-running, these compact blocks are the foundation of the Harken block line. We offer them in multiple configurations for dinghies, scows, beachcats, iceboats, and small offshore racers and cruisers.



Corrosion-resistant, maintain beauty and strength over time

- Ball bearings, sheave, and sideplates are UV-stabilized.
- Corrosion-resistant stainless steel straps reinforce blocks.

Fast trim and release under load

- Free-running ball bearings roll on flat races with minimal friction.

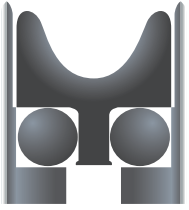

Shackle blocks lock in two directions or swivel to keep line from twisting

- Set screw allows shackle to be fixed or to swivel.

Materials

For properties see pages 16-17.



Delrin® UV-stabilized:
Ball bearings



316 Stainless steel:
Sideplate straps

Delrin is a registered trademark of E. I. du Pont de Nemours and Company or its affiliates. DO NOT use Harken equipment for human suspension unless product is specifically certified and labeled for such use.



Bullet Blocks

Low-friction Bullet blocks lead control lines aft. They are compact and lightweight, with fast trim and release under high or low loads. A range of styles lets these blocks adapt to almost all control line applications.

Wire Bullet blocks use roller bearings to carry higher loads and feature Hard Lube-anodized aluminum sheaves for strength and corrosion resistance. Mast exit blocks with cams are used for halyard controls and under boom mainsheets.

About Classic blocks: see feature page at beginning of this section.



Integrated shackle minimizes block length for purchase power in limited space.

The complete line of Small Boat Classic blocks is available through Harken dealers worldwide and online at www.harken.com/classic

Sheaves see page 78.

Part No.	Description	Sheave Ø		Length		Weight		Shackle pin Ø		Max line Ø		Maximum working load		Breaking load	
		in	mm	in	mm	oz	g	in	mm	in	mm	lb	kg	lb	kg
Bullet															
082	Single	1 1/8	29	2	51	1	28			5/16	8	300	136	2000	907
083	Single/becket	1 1/8	29	2 3/4	70	1.25	35			5/16	8	300	136	2000	907
084	Double	1 1/8	29	2 3/4	70	2.5	71	3/16	5	5/16	8	400	181	2000	907
085	Double/becket	1 1/8	29	3 1/2	89	2.75	78	3/16	5	5/16	8	400	181	2000	907
086	Triple	1 1/8	29	3	76	3.75	106	3/16	5	5/16	8	600	272	2000	907
087	Triple/becket	1 1/8	29	3 3/4	95	4.5	128	3/16	5	5/16	8	600	272	2000	907
098	Wire single	1 1/8	29	2	51	1	28			5/16	8	500	227	2000	907
099	Wire single/becket	1 1/8	29	2 3/4	70	1.25	35			5/16	8	500	227	2000	907
100	Double wire	1 1/8	29	2 3/4	70	2.75	78	3/16	5	5/16	8	750	340	2000	907
109	Wire cheek*	1 1/8	29	2 7/8	73	1.25	35			5/16	8	500	227	2000	907
113	Pivoting cheek*	1 1/8	29	1 1/8	29	1	28			5/16	8	300	136	2000	907
166	Single/swivel	1 1/8	29	2 3/4	70	1.5	43	3/16	5	5/16	8	300	136	2000	907
167	Single/swivel/becket	1 1/8	29	3 1/2	89	1.75	50	3/16	5	5/16	8	300	136	2000	907
183	Wire swivel	1 1/8	29	2 3/4	70	1.5	43	3/16	5	5/16	8	500	227	2000	907
Big Bullet															
125	Single	1 1/2	38	2 1/2	64	1.5	43			3/8	10	300	136	2000	907
126	Single/becket	1 1/2	38	3 1/2	89	2	57			3/8	10	300	136	2000	907
127	Double	1 1/2	38	3 1/2	89	4.25	120	1/4	6	3/8	10	600	272	2000	907
128	Double/becket	1 1/2	38	4 1/2	114	4.75	135	1/4	6	3/8	10	600	272	2000	907
129	Triple	1 1/2	38	3 3/4	95	6.5	184	1/4	6	3/8	10	750	340	2000	907
130	Triple/becket	1 1/2	38	4 3/4	121	6.75	191	1/4	6	3/8	10	750	340	2000	907
146	Single/shackle	1 1/2	38	3 1/8	79	2	57	3/16	5	3/8	10	300	136	2000	907
147	Single/shackle/becket	1 1/2	38	4	102	2.25	64	3/16	5	3/8	10	300	136	2000	907
168	Single/swivel	1 1/2	38	3 1/4	83	2.25	64	3/16	5	3/8	10	300	136	2000	907
169	Single/swivel/becket	1 1/2	38	4	102	2.5	71	3/16	5	3/8	10	300	136	2000	907
Upright															
448	Halyard lead block	1 1/2	38	2	51	2.1	60			3/8	10	300	136	600	272

*5 mm (#10) RH fasteners.

Bullet, Dinghy & Exit Blocks

About Classic blocks: see feature page at beginning of this section.

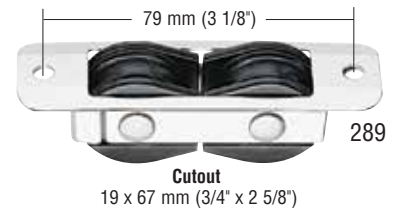
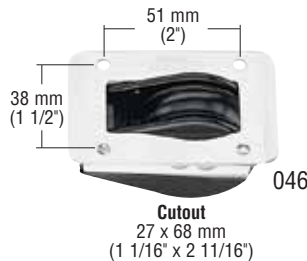
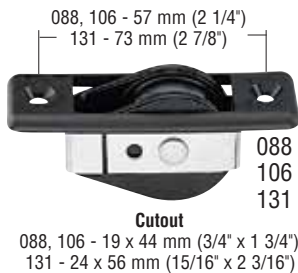
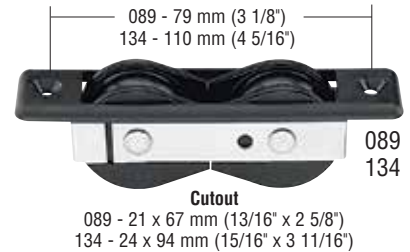
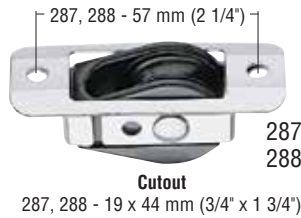

The complete line of Small Boat Classic blocks is available through Harken dealers worldwide and online at www.harken.com/classic

Part No.	Description	Sheave Ø		Length		Weight		Max line Ø		Maximum working load		Breaking load	
		in	mm	in	mm	oz	g	in	mm	lb	kg	lb	kg
Bullet													
088	Through-deck*	1 1/8	29	3	76	1.25	35	5/16	8	300	136	2000	907
089	In-line exit*	1 1/8	29	3 3/4	95	1.75	50	5/16	8	400	181	2000	907
096	Upright**	1 1/8	29	1 1/2	38	1.5	43	5/16	8	300	136	2000	907
106	Wire through-deck*	1 1/8	29	3	76	1.25	35	5/16	8	500	227	2000	907
108	Wire upright**	1 1/8	29	1 1/2	38	1.5	43	5/16	8	500	227	2000	907
110	Through-deck*	1 1/8	29	3	76	2.12	60	5/16	8	300	136	2000	907
197	Exit/150 Cam-Matic (port/stbd)**	1 1/8	29	3	76	4.5	128	5/16	8	300	136	2000	907
220	Double upright**	1 1/8	29	1 1/2	38	2.25	64	5/16	8	400	181	2000	907
287	Through-deck**	1 1/8	29	3	76	1.25	35	5/16	8	300	136	2000	907
288	Wire through-deck**	1 1/8	29	3	76	1.5	43	5/16	8	400	181	2000	907
289	In-line exit**	1 1/8	29	3 3/4	95	2.12	60	5/16	8	400	181	2000	907
Big Bullet													
131	Through-deck*	1 1/2	38	3 1/2	89	2.25	64	3/8	10	300	136	2000	907
134	In-line exit*	1 1/2	38	5	127	3.25	92	3/8	10	600	272	2000	907
222	Upright**	1 1/2	38	2 1/4	57	2.5	71	3/8	10	300	136	2000	907
223	Double upright**	1 1/2	38	2 1/4	57	3.25	92	3/8	10	600	272	2000	907
Dinghy													
046	Through-deck‡	1 3/4	44	3	76	4	113	3/8	10	350	159	2000	907

*5 mm (#10) FH fasteners. **5 mm (#10) RH fasteners. ‡4 mm (#8) RH fasteners. Contact Harken for other Dinghy 44 mm (1 3/4") blocks.



2.25" Blocks

About Classic blocks: see feature page at beginning of this section.

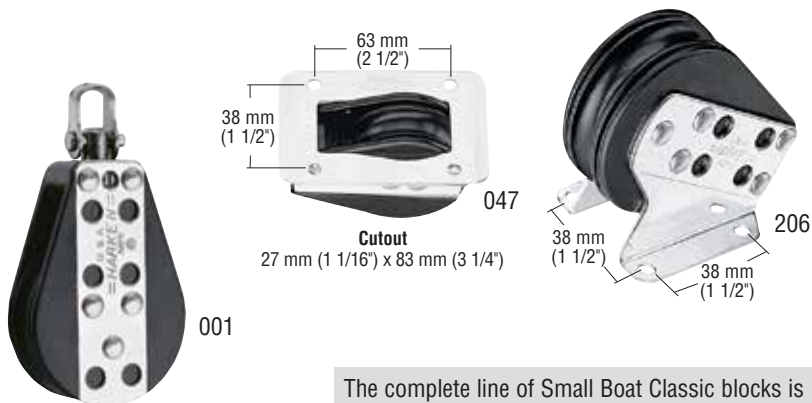

The complete line of Small Boat Classic blocks is available through Harken dealers worldwide and online at www.harken.com/classic.

Part No.	Description	Sheave Ø		Length		Weight		Shackle pin Ø		Max line Ø		Maximum working load		Breaking load	
		in	mm	in	mm	oz	g	in	mm	in	mm	lb	kg	lb	kg
001	Single	2 1/4	57	4 1/4	108	4.5	128	3/16	5	7/16	12	500	227	2500	1134
047	Through-deck*	2 1/4	57	3 1/2	89	5.5	156			7/16	12	500	227	2500	1134
206	Upright lead**	2 1/4	57	3 1/4	83	5.5	156			7/16	12	500	227	2500	1134

*#8 (4 mm) RH fasteners. **#10 (5 mm) RH fasteners.

Hexa-Cat Bases

Combine the 193 and 170 Hexa-Cat bases with Big Bullet or 2.25" (57 mm) blocks for purchases from 5:1 to 8:1.

About Classic blocks: see feature page at beginning of this section.



Hexa-Cat maximum working loads

	Base	5:1		6:1		7:1		8:1	
		lb	kg	lb	kg	lb	kg	lb	kg
Little Hexa-Cats	193	1100	499	1100	499	1250	567	1250	567
Hexa-Cats	170	1500	680	1500	680	1500	680	1500	680

Boom blocks (single block on boom)

5:1		6:1		7:1		8:1
Little Hexa-Cat	Hexa-Cat	Little Hexa-Cat	Hexa-Cat	Little Hexa-Cat	Hexa-Cat	Little Hexa-Cat
128	004/2603/2663	129	048/2604 or 2664	130	2605 or 2665	2654

Boom blocks (multiple blocks on boom)

126/125	001/002 or 2601/2600 2660/2661	125/127	001/003 or 2602/2600 2662/2660	126/127	002/003 or 2603/2600 2663/2660	2 x 127
---------	--------------------------------	---------	--------------------------------	---------	--------------------------------	---------

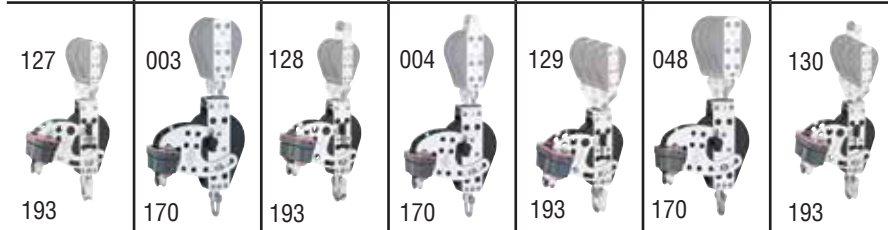

The complete line of Small Boat Classic blocks is available through Harken dealers worldwide and online at www.harken.com/classic.

Part No.	Description	Sheave Ø		Length		Weight		Shackle pin Ø		Max line Ø		Breaking load	
		in	mm	in	mm	oz	g	in	mm	in	mm	lb	kg
170	Hexa-Cat/150 Cam-Matic	3	76	7 1/4	184	16.5	468	1/4	6	7/16	12	3000	1361
193	Little Hexa-Cat/150 Cam-Matic	2 1/4	57	5 3/4	146	12	340	1/4	6	3/8	10	2500	1134

GP Catamaran Ceramic Mainsheet Systems



GP cat mainsheet Asked & Answered



10:1, 11:1, 12:1 configurations in a single package

Harken's Grand-Prix mainsheet systems are critically important options for high-performance beachcats like the Nacra 17 or F18s. The high-efficiency blocks making up these systems feature insert-molded ceramic bearings that almost eliminate rolling resistance, greatly improving power transfer to the crew for easy, precise trimming. These compact blocks feature hardcoat-anodized sideplates that envelop composite sheaves for easy disassembly/reassembly. The system profile is the lowest on the market by far. High-performance fairing increases aerodynamic flow and protects the crew and blocks from impact damage. The lower block features a built-in cam arm that infinitely adjusts by loosening two (2) screws with a hex key. A single ratchet sheave in the bottom block ensures release is controlled and smooth. A snap shackle attaches the block to the boom. A swivel shackle attaches to the traveler.

Note: the GP mainsheet system is delivered as a 12:1 mainsheet system, but can be easily reconfigured as a 10:1 or an 11:1 to align with wind or crew preference. All necessary parts and reeving instructions are included. Line not included.



2800

Part No.	Description	Sheave Ø		Pin-to-pin length		Weight		Max line Ø		Maximum working load		Breaking load	
		in	mm	in	mm	oz	g	in	mm	lb	kg	lb	kg
2800	12:1 GP catamaran mainsheet system	2 5/16	59	8 13/16	224	36.6	1039	5/16	8	1200	545	3600	1636

Two-Speed Mainsheet Systems

Harken gross-trim/fine-tune mainsheet systems are easy to install and use. These optimized systems decrease overall line clutter because they use less line than traditional gross-trim/fine-tune systems. For fast trimming, pull both tails of the mainsheet. To fine-tune or to trim using a higher purchase, pull a single tail.

Two-speed mainsheet systems come in three configurations for boats from 6.5 m to 11.8 m (22 - 39'), with mains as large as 32.4 m² (350 ft²).

Systems

Part No.	Description	Line Ø				Max mainsail area			
		Min		Max		End-boom		Mid-boom	
		in	mm	in	mm	ft ²	m ²	ft ²	m ²
332	3:1/6:1 self-contained system*	5/16	8	3/8	10	240	22.3	180	16.9
383	4:1/8:1 self-contained system*	5/16	8	3/8	10	350	32.4	275	25.5

*Line not included.

Components

Part No.	Description	Sheave Ø				Length		Weight	
		Primary		Secondary		in	mm	oz	g
		in	mm	in	mm	in	mm	oz	g
385	Double fiddle	3	76	1 3/4	44	7 3/4	197	21	595
386	Double fiddle/ratchet/cross block/412 Cam-Matic	3	76	2 1/4, 1 3/4	57, 44	11 1/2	292	37	1049
400	Double/cross block	3	76	2 1/4	57	9 1/2	241	22	625
401	Double fiddle/ratchet/412 Cam-Matic	3	76	1 3/4	44	7 1/4	184	31	885

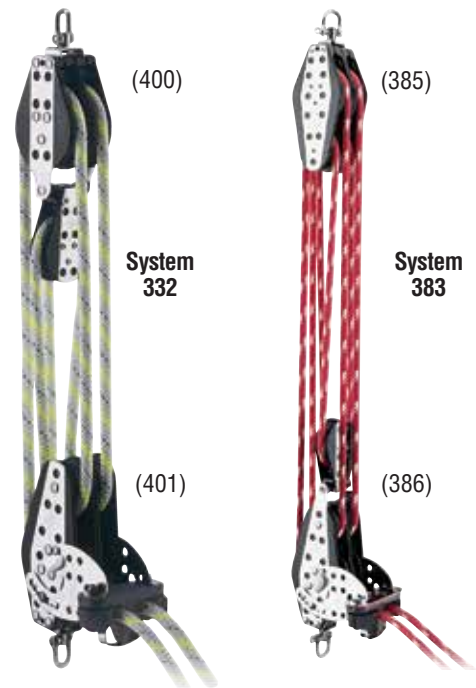

(400)

(385)

System 332

System 383

(401)

(386)



Ordering Midrange Blocks

1. Determine block size and type

The tables below are guidelines for typical applications. Additional rigging tips are available at <http://www.harken.com>.

2. Contact

If you have questions, please contact your dealer or Harken Technical Service.

Note: Multihulls and heavy displacement monohulls should reduce the maximum sail areas shown by as much as 25%.

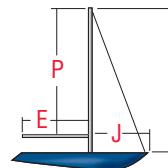

Mainsheet

The farther forward a mainsheet system is on the boom, the higher the loads. Systems with multiple attachment points spread the load over the boom. Use the table to determine if Midrange blocks are strong enough for your mainsail area. See pages 262 - 264 for common configurations.

Mainsheet

		Maximum mainsail area (P x E x .5 x 1.1*)	
		ft ²	m ²
End-boom system	Single attachment	500	46
	Multiple attachment†	540	50
Mid-boom system	Single attachment	425	39
	Multiple attachment†	500	46

*Assumes 10% roach. †Assumes two or more shackles share load on both boom and deck.

Genoa Footblocks

Determine the area of your foretriangle and how many degrees the footblock will deflect the line to select footblock size. For system loading details, see the **Block Loading vs. Angle of Deflection** and **Genoa System Loading** sections on page 279. See page 259 for common configurations.

Genoa Footblocks

	Maximum 100% foretriangle sail area at 35 knots (I x J x .5)	
	ft ²	m ²
180° turn	150	14
90° turn	215	20

Spinnaker: Symmetrical/Asymmetrical

Use the spinnaker's sail area to determine what size Midrange or high-load Midrange blocks to use for the sheet and afterguy controls. See page 269 for common configurations.

Spinnaker

		Maximum spinnaker area (P x E x .5 x 1.8)			
		Standard		High-load	
		ft ²	m ²	ft ²	m ²
Sheet	Plain	1100	100	1300	120
	Ratchet	900	83	—	—
Afterguy*	Mounted amidships	1100	100	1250	115
	Mounted on transom	900	83	1000	93
		Maximum "I" dimension			
Masthead halyard		48	14.6	53	16

*Assumes maximum deflection of 45°.

Mastbase Lead Blocks

Attach blocks to padeyes or 1634 Midrange ESP stand-up bases, or mount mastbase halyard leads to the deck. Use mainsail luff length and foretriangle height to determine what size Midrange or high-load Midrange blocks to use. Carbo blocks or 1986 mastbase halyard leads may be appropriate for applications with lower loads. See page 268 for common configurations.

Mastbase Lead Blocks

	Standard		High-load	
	ft	m	ft	m
Maximum "P" dimension				
Main halyard lead	48	14.6	52	15.8
Maximum "I" dimension				
Genoa halyard lead	46	14	50	15.3
Maximum "I" dimension				
Spinnaker halyard lead	48	14.6	53	16

Running Backstays

The table below shows if Midrange or high-load Midrange blocks are strong enough for the backstay, based on the breaking strength of the runner wire.

Running Backstays

	Maximum breaking load of runner wire			
	Standard		High-load	
	lb	kg	lb	kg
2:1 flying blocks				
1:1 afterguy deck	2200	998	2800	1270
2:1 afterguy becket deck	3600	1633	3600	1633
2:1 afterguy single deck	4500	2040	5000	2268

Vang

See page 265 for common configurations.

Vang

	Maximum mainsail area (P x E x .5 x 1.1*)	
	ft ²	m ²
Fiddle	400	37
Triple	450	42

*Assumes 10% roach.

Midrange Blocks

About Classic blocks: see feature page at beginning of this section.



STANDARD



HEXARATCHET



Hexaratchet blocks
Midrange Hexaratchet blocks grip loaded sheets, yet allow sailors to ease and trim quickly and with complete control. A switch on the side engages and disengages the ratchet mechanism.

Eight-sided aluminum sheave for 10:1 or 15:1 holding power with 180° wrap.

Torlon is a registered trademark of Solvay Advanced Polymers L.L.C.

Part No.	Description	Sheave Ø		Length		Weight		Shackle pin Ø		Max line Ø		Maximum working load		Breaking load	
		in	mm	in	mm	oz	g	in	mm	in	mm	lb	kg	lb	kg
Standard															
1540	Single	3	76	6 1/8	156	13	367	5/16	8	9/16	14	1800	816	5000	2268
1541	Single/becket	3	76	7 1/8	184	14	397	5/16	8	9/16	14	1800	816	5000	2268
1542	Single/aluminum sheave	3	76	6 1/8	156	15	425	5/16	8	9/16	14	1800	816	5000	2268
1544	Double	3	76	7 1/2	191	25.5	723	5/16	8	9/16	14	2800	1270	7000	3175
1545	Double/becket	3	76	8 1/2	216	26.5	751	5/16	8	9/16	14	2800	1270	7000	3175
1546	Triple	3	76	7 3/4	197	36	1020	5/16	8	9/16	14	3800	1724	8500	3856
1548	Cheek*	3	76	4 3/8	111	11	312			9/16	14	1500	680	4200	1905
1559	Fiddle	3:2	76:51	8 1/2	216	17	482	5/16	8	9/16	14	1800	816	5000	2268
1560	Fiddle/becket	3:2	76:51	9 1/2	241	18	510	5/16	8	9/16	14	1800	816	5000	2268
1564	Fiddle/280 Cam-Matic/becket	3:2	76:51	9 1/2	241	24.5	695	5/16	8	9/16	14	1800	816	5000	2268
1586	Single/high-load**	3	76	6 1/8	156	13	367	5/16	8	9/16	14	2300	1043	5000	2268
Hexaratchet															
1549	Single/clockwise	3	76	6 1/8	156	14	397	5/16	8	9/16	14	1800	816	5000	2268
1550	Single/becket/clockwise	3	76	7 1/8	184	15	425	5/16	8	9/16	14	1800	816	5000	2268
1555	Triple/280 Cam-Matic/clockwise	3	76	7 3/4	197	49	1389	5/16	8	9/16	14	3800	1724	8500	3856
1556	Triple/280 Cam-Matic/becket/clockwise	3	76	8 3/4	222	51	1446	5/16	8	9/16	14	3800	1724	8500	3856
1571	Single/counterclockwise	3	76	6 1/8	156	14	397	5/16	8	9/16	14	1800	816	5000	2268
1565	Fiddle/280 Cam-Matic/clockwise	3:2	76:51	8 1/2	216	26.5	751	5/16	8	9/16	14	1800	816	5000	2268
1566	Fiddle/280 Cam-Matic/becket/clockwise	3:2	76:51	9 1/2	241	27.5	780	5/16	8	9/16	14	1800	816	5000	2268

*6 mm (1/4") RH fasteners. **High-load Midrange blocks use Torlon® ball bearings.



Line/Wire High Strength Blocks

Lightweight, low-friction wire blocks carry wire halyards and high-strength control lines on boats of all sizes.

High-load composite bearings carry axial loads. Hard Lube-anodized sheave for strength and corrosion resistance.

25 mm (1") wire blocks use low-friction thrust washers. 38 mm (1.5") and 51 mm (2") wire blocks feature sideload balls between the sheave and the sideplate to minimize friction from unfair leads.

466 features a forkhead and becket making it useful for vang, halyards and control lines.

Use for:

- Wire halyards
- Vangs
- Control lines



High-load composite bearings handle wire and high-strength line.



Sideplates rotate to insert preswaged/Nico-pressed wire fittings.

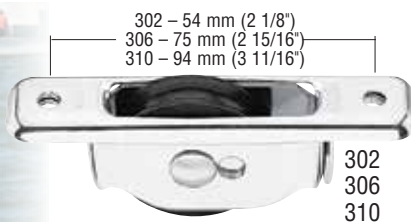

Cutout

- 302 11 mm (13/32") x 39 mm (1 17/32")
- 306 13 mm (17/32") x 59 mm (2 5/16")
- 310 14 mm (9/16") x 73 mm (2 23/32")



Lightning © Phil Page Photography

Part No.	Description	Sheave Ø		Weight		Shackle pin Ø		Max wire Ø		Max line Ø		Maximum working load		Breaking load	
		in	mm	oz	g	in	mm	in	mm	in	mm	lb	kg	lb	kg
300	Single	1	25	1	28	3/16	5	3/32	2	5/32	4	1000	454	2000	907
301	Cheek†*	1	25	1.25	35			3/32	2	5/32	4	1000	454	2000	907
302	Through-deck*	1	25	1	28			3/32	2	5/32	4	1000	454	2000	907
304	Single	1 1/2	38	2.75	78	1/4	6	1/8	3	3/16	5	1500	680	3000	1361
305	Cheek†**	1 1/2	38	3.25	92			1/8	3	3/16	5	1500	680	3000	1361
306	Through-deck*	1 1/2	38	3.25	92			1/8	3	3/16	5	1500	680	3000	1361
308	Single	2	51	5.25	149	5/16	8	3/16	5	1/4	6	2000	907	4000	1814
309	Cheek†***	2	51	6	170			3/16	5	1/4	6	2000	907	4000	1814
310	Through-deck**	2	51	5.75	163			3/16	5	1/4	6	2000	907	4000	1814
312	Single/becket	1	25	1.25	35	3/16	5	3/32	2	5/32	4	1000	454	2000	907
313	Single/becket	1 1/2	38	3	85	1/4	6	1/8	3	3/16	5	1500	680	3000	1361
314	Single/becket	2	51	5.75	163	5/16	8	3/16	5	1/4	6	2000	907	4000	1814
320	Ferrule head	1 1/2	38	3	85			1/8	3	3/16	5	1500	680	3000	1361
321	Small split backstay plate for 304			1	28										
466	Single forkhead/becket	1	25	1.02	29	3/16	5	3/32	2	5/32	4	1000	454	2000	907

†Fasteners included. *#10 (5 mm) RH fasteners. ** 6 mm (1/4") RH fasteners. *** 8 mm (5/16") RH fasteners.

BIG BOAT BLOCKS

NEW FOR 2020



**Element
stand-up**
SEE PAGES 49-51



V blocks
SEE PAGES 66-67



Ordering Big Boat Blocks

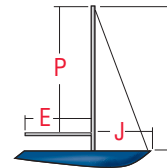

1. Determine block size and type

The tables below are a guideline for typical applications. Additional rigging tips are available at <http://www.harken.com>.

2. Contact

If you have any questions, please contact your dealer or Harken Technical Service.

Note: These hardware specifications assume a boat of moderate displacement sailing in normal conditions. Ultralight displacement boats (ULDB) may use smaller hardware. Heavy displacement boats and multihulls often require stronger hardware.

Mainsheet

Mainsheets are usually attached near the end or the middle of the boom, depending on accessibility and whether the boat is used for racing or cruising. The farther forward a mainsheet system is on the boom, the higher the loads it sees. Systems with multiple attachment points spread the load over the boom. Use the table to choose the appropriate Black Magic, Element, or stainless steel blocks for your mainsail area. See pages 262-264 for common configurations.

	Maximum mainsail area (P x E x .5 x 1.1*)													
	45 mm Element* 57 mm low-load Black Magic		60 mm Element* 57 mm high-load Black Magic		75 mm low-load Black Magic/ 75 mm ESP		80 mm Element* 75 mm high-load Black Magic/ 75 mm stainless		100 mm Black Magic/ 100 mm stainless		125 mm Black Magic		150 mm Black Magic/ 150 mm stainless	
	ft ²	m ²	ft ²	m ²	ft ²	m ²	ft ²	m ²	ft ²	m ²	ft ²	m ²	ft ²	m ²
End-boom														
Single attachment	450	41	550	51	600	56	750	70	900	84	1250	116	1550	144
Multiple attachment**†	500	46	675	63	720	67	900	84	1100	102	1500	139	1750	163
Mid-boom														
Single attachment	400	37	400	37	450	42	550	51	700	65	1000	93	1375	128
Multiple attachment**	450	41	575	53	600	56	700	65	950	88	1300	121	1525	142

*Element blocks are appropriate for most cruising boats. For high-performance boats, choose Black Magic blocks.

**Assumes 10% roach. †Assumes two or more shackles share load on both boom and deck.

Running Backstays

Crews use running backstays to adjust mast bend for different wind conditions. This controls headsail sag as well as the camber (depth) of the mainsail. Use Black Magic Air Runner blocks with higher breaking strengths than your runner wire.

	Maximum breaking load of runner wire									
	57 mm Black Magic Air Runner		75 mm Black Magic Air Runner		100 mm Black Magic Air Runner		125 mm Black Magic Air Runner		150 mm Black Magic Air Runner	
	lb	kg	lb	kg	lb	kg	lb	kg	lb	kg
Flying	2500	1134	10000	4535	15000	6800	22000	10000	30000	13605
2:1 Separate deck	3025	1372	12100	5490	17550	7960	26500	12020	36136	16388
2:1 Becket deck	1875	850	7500	3400	10900	4945	16500	7485	22500	10204
3:1 Deck (block #1)	3713	1684	14850	6735	21600	9800	32700	14835	44550	20203
3:1 Deck (block #2)	4525	2052	18100	8210	26300	11930	39850	18075	54300	24625

Mastbase Lead Blocks

Leading halyards and control lines aft allows crews to raise and lower sails or make tuning adjustments from the cockpit. Attach blocks to the mast collar post or padeyes, or mount mastbase halyard leads to the deck. The table below sizes Black Magic, ESP, stainless steel, and mastbase blocks for different foretriangle heights and luff lengths. See page 268 for common configurations.

	45 mm Element* 57 mm low-load Black Magic/ESP		60 mm Element* 57 mm high-load Black Magic/ fixed MBL** blocks		75 mm low-load Black Magic/ Mast collar post block/ 75 mm ESP		80 mm Element* 75 mm high-load Black Magic/fixd MBL** blocks/ 75 mm stainless		100 mm Black Magic/ 100 mm stainless		125 mm Black Magic	
	ft	m	ft	m	ft	m	ft	m	ft	m	ft	m
	Maximum "P" Dimension											
Main halyard	47	14.3	52	15.8	60	18.3	74	22.6	80	25	90	27.5
Maximum "I" Dimension												
Genoa halyard	45	13.7	50	15.2	58	17.7	72	21.9	76	23.2	87	26.5
Spinnaker halyard	47	14.3	53	16.1	60	18.3	74	22.6	82	25	93	28.4

*Element blocks are appropriate for most cruising boats. For high-performance boats, choose Black Magic blocks. **MBL = Mastbase lead blocks.

Ordering Big Boat Blocks



Tattler II, 19.2 m (63'), Gaff-rigged Sandbagger, Van Dam Custom Boats © Alison Langley

Spinnaker: Symmetrical/Asymmetrical

Use the spinnaker's sail area to determine what size Black Magic, ESP, or stainless steel blocks to use for the sheet and afterguy controls. See pages 269-270 for common configurations.

	Maximum spinnaker area (1 x J x 1.8)													
	45 mm Element* 57 mm low-load Black Magic		60 mm Element* 57 mm high-load Black Magic		80 mm Element* 75 mm low-load Black Magic/ 75 mm ESP		75 mm high-load Black Magic/ 75 mm stainless		100 mm Black Magic/ 100 mm stainless		125 mm Black Magic		150 mm Black Magic/ 150 mm stainless	
	ft ²	m ²	ft ²	m ²	ft ²	m ²	ft ²	m ²	ft ²	m ²	ft ²	m ²	ft ²	m ²
Spinnaker sheet, tack line	720	67	1200	111	1400	130	2000	186	2650	246	4300	400	5600	520
Afterguy**	790	73	1320	123	1500	140	2200	204	2900	269	4700	437	6100	567

*Element blocks are appropriate for most cruising boats. For high-performance boats, choose Black Magic blocks. **Assumes maximum deflection of 45° to winch.

Genoa Footblocks

Footblocks route genoa controls from the lead car to a winch. Double footblocks or snatch blocks enable faster sheet changes. Determine the area of your foretriangle and how many degrees the footblock will deflect the line to select footblock size. For system loading details, refer to the **Block Loading vs Angle of Deflection** and **Genoa System Loading** sections on page 279. See page 259 for common configurations.

Single Genoa Footblocks

	Maximum 100% foretriangle sail area at 40 knots (1 x J x .5)													
	45 mm Element* 57 mm low-load Black Magic		60 mm Element* 57 mm high-load Black Magic		80 mm Element* 75 mm Black Magic/ 75 mm stainless		100 mm Black Magic/ 100 mm stainless		125 mm Black Magic		150 mm Black Magic/ 150 mm stainless			
	ft ²	m ²	ft ²	m ²	ft ²	m ²	ft ²	m ²	ft ²	m ²	ft ²	m ²	ft ²	m ²
180° turn	110	10	180	17	365	34	540	50	800	74	1100	102	1100	102
120° turn	125	12	210	20	420	39	630	59	920	85	1256	117	1256	117
90° turn	155	14	260	24	515	48	770	72	1130	105	1540	143	1540	143

*Element blocks are appropriate for most cruising boats. For high-performance boats, choose Black Magic blocks.

Double Genoa Footblocks

	Maximum 100% foretriangle sail area at 40 knots* (1 x J x .5)									
	57 mm low-load Black Magic		60 mm Element** 57 mm high-load Black Magic		80 mm Element** 75 mm Black Magic		100 mm Black Magic		125 mm Black Magic	
	ft ²	m ²	ft ²	m ²	ft ²	m ²	ft ²	m ²	ft ²	m ²
180° turn	75	7	120	11	240	22	360	33	530	49
120° turn	85	8	140	13	275	26	415	39	610	57
90° turn	105	10	175	16	340	32	510	47	750	70

*Based on load on upper sheave. **Element blocks are appropriate for most cruising boats. For high-performance boats, choose Black Magic blocks.



Flag, GS 48, 14.90 m (48.9') © Fabio Taccola / Grand Soleil Yachts

ELEMENT BLOCKS



Harken Element Block

When Harken sets out to create a block for sailors who have always believed they didn't need Harken, what happens? The new Element block. The name hints at its essence: everything that doesn't contribute durability or strength is stripped away. The result is an economical block that does a Harken job.

Element blocks introduce sideplates that combine forged aluminum and compound curves for strength. They are simultaneously contemporary and very robust. Element's design pairs the minimum amount of metal required to protect the sheave with a proven journal bearing. So size for size, Element is priced significantly lower, than our previously least expensive blocks. Compare them to plain bearing blocks from competitors, you'll be surprised. Element: Harken design and engineering—value-price.

Element blocks accept line from 8 - 16 mm. They are offered in singles, doubles, triples, fiddles, and footblocks in 45, 60 and 80 mm sizes.

Stands up to sun, salt, and impact

- Aluminum sideplates are forged for strength and sheave protection.
- Sideplates are hardcoat-anodized to resist corrosion.
- Bearing sheave of tough composite resists corrosion for a long service life.
- Shackles are strong, corrosion-resistant stainless steel.

Materials
For properties see pages 16-17.



6061-T6 aluminum:
Hardcoat-anodized sideplates



Shackle blocks lock in two directions or swivel to keep line from twisting

- Removable headpost lock allows shackle to be fixed or to swivel.

45 mm Blocks

About Element blocks: see feature page at beginning of this section.



Part No.	Description	Sheave Ø		Length		Weight		Shackle pin Ø		Max line Ø		Maximum working load		Breaking load	
		in	mm	in	mm	oz	g	in	mm	in	mm	lb	kg	lb	kg
6230	Single/swivel	1 3/4	45	4	102	3.6	103	1/4	6	1/2	12	1543	700	3086	1400
6231	Single/swivel/becket	1 3/4	45	4 3/4	121	4.0	115	1/4	6	1/2	12	1543	700	3086	1400
6232	Fiddle/swivel	1 3/4	45	5 1/8	130	4.4	126	1/4	6	5/16	8	1543	700	3086	1400
6233	Fiddle/swivel/becket	1 3/4	45	5 3/4	146	4.6	130	1/4	6	5/16	8	1543	700	3086	1400
6234	Fiddle/150 Cam-Matic/swivel/becket	1 3/4	45	5 3/4	146	8.6	245	1/4	6	5/16	8	1213	550	2426	1100
6235	Fiddle/150 Cam-Matic/swivel	1 3/4	45	5 1/8	130	8.4	241	1/4	6	5/16	8	900	408	1800	816
6236	Single/150 Cam-Matic/swivel/becket	1 3/4	45	4 3/4	121	8.1	230	1/4	6	1/2	12	600	272	1200	544
6238	Double/swivel	1 3/4	45	4 1/4	108	6.3	180	1/4	6	1/2	12	1929	875	3858	1750
6239	Double/swivel/becket	1 3/4	45	5	127	6.8	195	1/4	6	1/2	12	1929	875	3858	1750
6240	Triple/swivel	1 3/4	45	4 1/4	108	9.3	265	1/4	6	1/2	12	2315	1050	4630	2100
6241	Triple/swivel/becket	1 3/4	45	5	127	9.6	275	1/4	6	1/2	12	2315	1050	4630	2100
6242	Triple/150 Cam-Matic/swivel	1 3/4	45	4 1/4	108	14.7	420	1/4	6	1/2	12	1499	680	2998	1360
6243	Triple/150 Cam-Matic/swivel/becket	1 3/4	45	5	127	15.1	430	1/4	6	1/2	12	1799	816	3598	1632
6250	Stand-up	1 3/4	45	4 7/8	123	5.3	150			1/2	12	1543	700	3086	1400
6251	Stand-up/becket	1 3/4	45	5 5/8	143	5.8	164			1/2	12	1543	700	3086	1400

Footblock Dimensions

Part No.	A		B		C		D	
	in	mm	in	mm	in	mm	in	mm
6237	7/16	11	1 5/8	41.5	1 3/4	45	3/8	9.5

Footblock

Part No.	Description	Sheave Ø		Length		Height		Weight		Max line Ø		Maximum working load		Breaking load		Fasteners (FH)
		in	mm	in	mm	in	mm	oz	g	in	mm	lb	kg	lb	kg	
6237	Single footblock	1 3/4	45	3	76	1	25	3.5	100	1/2	12	1543	700	3086	1400	6

60 mm Blocks

About Element blocks: see feature page at beginning of this section.

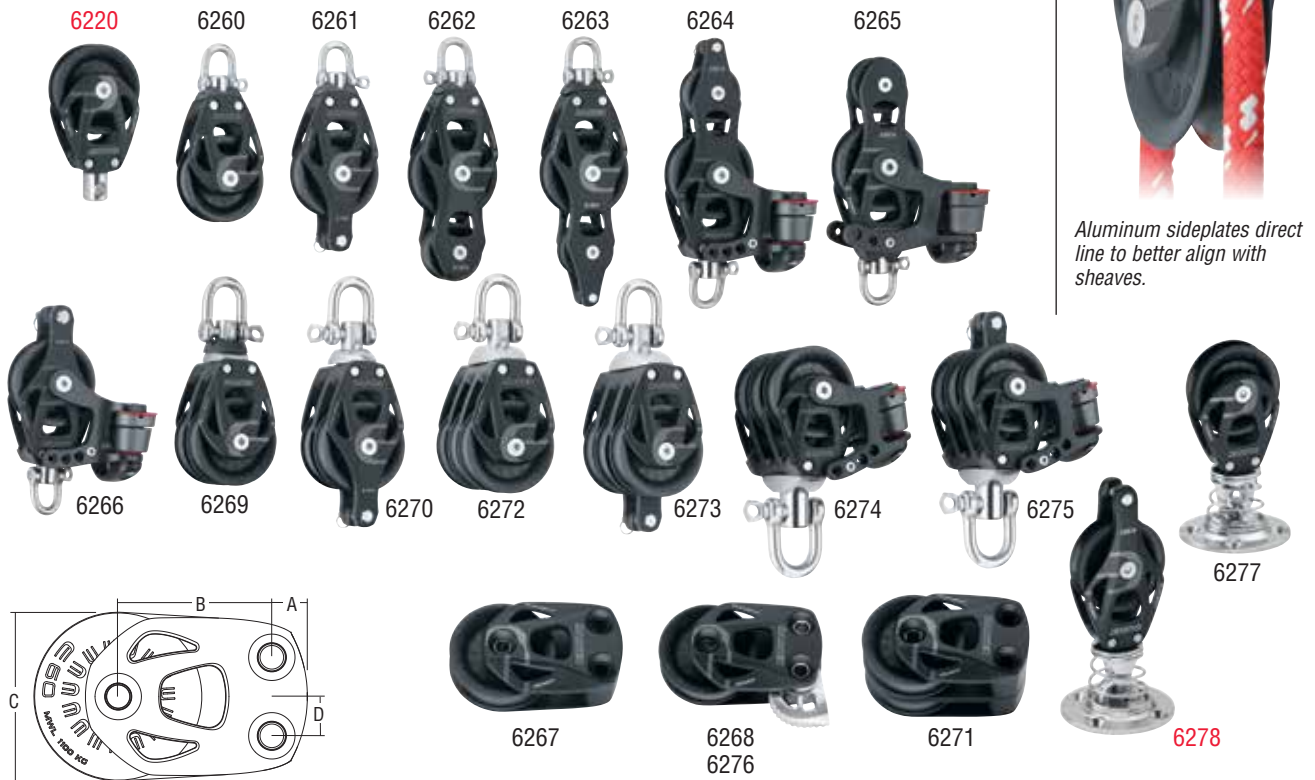

Part No.	Description	Sheave Ø		Length		Weight		Shackle pin Ø		Max line Ø		Maximum working load		Breaking load	
		in	mm	in	mm	oz	g	in	mm	in	mm	lb	kg	lb	kg
6220	Mastbase/single/swivel	2 3/8	60	4 1/8	105	5.5	155	8	9/16	14	2425	1100	4850	2200	
6260	Single/swivel	2 3/8	60	4 3/4	121	6.1	175	1/4	6	9/16	14	2425	1100	4850	2200
6261	Single/swivel/becket	2 3/8	60	5 3/4	146	7	200	1/4	6	9/16	14	2425	1100	4850	2200
6262	Fiddle/swivel	2 3/8	60	6 1/2	165	8.4	240	1/4	6	3/8	10	2425	1100	4850	2200
6263	Fiddle/swivel/becket	2 3/8	60	7 1/8	181	8.75	250	1/4	6	3/8	10	2425	1100	4850	2200
6264	Fiddle/150 Cam-Matic/swivel/becket	2 3/8	60	7 1/8	181	13.0	370	1/4	6	3/8	10	1213	550	2426	1100
6265	Fiddle/150 Cam-Matic/swivel	2 3/8	60	6 1/2	165	12.6	360	1/4	6	3/8	10	900	408	1800	816
6266	Single/150 Cam-Matic/swivel/becket	2 3/8	60	5 3/4	146	11.2	320	1/4	6	1/2	12	600	272	1200	544
6269	Double/swivel	2 3/8	60	5 3/4	146	12.4	355	5/16	8	9/16	14	3032	1375	6064	2750
6270	Double/swivel/becket	2 3/8	60	6 3/4	171	14.7	420	5/16	8	9/16	14	3032	1375	6064	2750
6272	Triple/swivel	2 3/8	60	5 3/4	146	18.2	520	5/16	8	9/16	14	3638	1650	7276	3300
6273	Triple/swivel/becket	2 3/8	60	6 1/2	165	18.9	540	5/16	8	9/16	14	3638	1650	7276	3300
6274	Triple/150 Cam-Matic/swivel	2 3/8	60	5 3/4	146	24.2	690	5/16	8	1/2	12	1499	680	2998	1360
6275	Triple/150 Cam-Matic/swivel/becket	2 3/8	60	6 1/2	165	24.9	710	5/16	8	1/2	12	1799	816	3598	1632
6277	Stand-up	2 3/8	60	5 1/4	133	13.8	391			9/16	14	2425	1100	4850	2200
6278	Stand-up/becket	2 3/8	60	6 1/8	155	14.8	419			9/16	14	2425	1100	4850	2200

Footblock Dimensions

Part No.	A		B		C		D	
	in	mm	in	mm	in	mm	in	mm
6267/6268/6271/6276	1/2	12.5	2 5/32	54.5	2 3/8	60	9/16	14

Footblocks

Part No.	Description	Sheave Ø		Length		Height		Weight		Max line Ø		Maximum working load		Breaking load		Fasteners (FH)
		in	mm	in	mm	in	mm	oz	g	in	mm	lb	kg	lb	kg	
6267	Single footblock	2 3/8	60	4	102	1 3/16	30	5.6	160	9/16	14	2425	1100	4850	2200	8
6268	Single footblock/lockoff	2 3/8	60	4	102	1 3/16	30	7.4	210	9/16	14	2425	1100	4850	2200	8
6271	Double footblock	2 3/8	60	4	102	2 3/16	55	9.3	265	9/16	14	1600	725	3200	1450	8
6276	Single footblock/lockoff/left	2 3/8	60	4	102	1 3/16	30	7.4	210	9/16	14	2425	1100	4850	2200	8

80 mm Blocks

About Element blocks: see feature page at beginning of this section.



Removable headpost lock allows shackle to be fixed or to swivel.

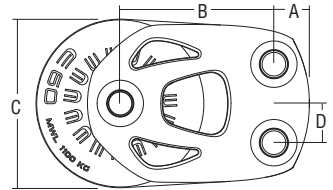

Part No.	Description	Sheave Ø		Length		Weight		Shackle pin Ø		Max line Ø		Maximum working load		Breaking load	
		in	mm	in	mm	oz	g	in	mm	in	mm	lb	kg	lb	kg
6221	Mastbase/single/swivel	3 1/8	80	5 1/2	138	12.6	358	10	5/8	16	4850	2200	9700	4400	
6280	Stand-up	3 1/8	80	6 9/16	166	23.6	670		5/8	16	4850	2200	9700	4400	
6290	Single/swivel	3 1/8	80	6 3/4	171	16.6	475	3/8	10	5/8	16	4850	2200	9700	4400
6291	Single/swivel/becket	3 1/8	80	8	203	18.9	540	3/8	10	5/8	16	4850	2200	9700	4400
6292	Fiddle/swivel	3 1/8	80	9	229	21.4	610	3/8	10	9/16	14	4850	2200	9700	4400
6293	Fiddle/swivel/becket	3 1/8	80	10	254	22.4	640	3/8	10	9/16	14	4850	2200	9700	4400
6296	Double/swivel	3 1/8	80	7 1/2	191	32.0	915	1/2	12	5/8	16	6064	2750	12128	5500
6297	Double/swivel/becket	3 1/8	80	8 3/4	222	34.3	980	1/2	12	5/8	16	6064	2750	12128	5500

Footblock Dimensions

Part No.	A		B		C		D	
	in	mm	in	mm	in	mm	in	mm
6294/6295/6298/6299	3/4	19.5	2 13/32	61	3 1/8	80	25/32	19.8

Footblocks

Part No.	Description	Sheave Ø		Length		Height		Weight		Max line Ø		Maximum working load		Breaking load		Fasteners (FH)
		in	mm	in	mm	in	mm	oz	g	in	mm	lb	kg	lb	kg	
6294	Single footblock	3 1/8	80	4 1/2	114	1 7/16	36	10.9	310	5/8	16	4850	2200	9700	4400	10
6295	Single footblock/lockoff	3 1/8	80	4 1/2	114	1 7/16	36	14.4	410	5/8	16	4850	2200	9700	4400	10
6298	Double footblock	3 1/8	80	4 1/2	114	2 9/16	65	20.3	580	5/8	16	3197	1450	6394	2900	10
6299	Single footblock/lockoff/left	3 1/8	80	4 1/2	114	1 7/16	36	14.4	410	5/8	16	4850	2200	9700	4400	10



Paluma, Solaris 47 - 14.33 m (47'), Solaris Yachts, naval architect: Javier Soto Acebal © Andrea Carloni / Solaris Yachts

BLACK MAGIC AIR BLOCKS

Black Magic Air blocks are a top favorite of Big Boat performance racers and cruisers. These lightweight, free-running, powerful performers are used for sail controls that see lots of action: mainsheet, runner, halyard, and spinnaker systems. Offered in 57 - 150 mm sizes, with low-load versions in 57 and 75 mm ranges.



High-strength, lightweight

- Aluminum sheaves and sideplates.
- CNC sculpted for optimal strength-to-weight.

Stands up to sun, salt, and time

- Sideplates and sheaves Hard Lube-anodized for maximum UV protection and a smooth surface.
- Dissimilar metals isolated to prevent corrosion.

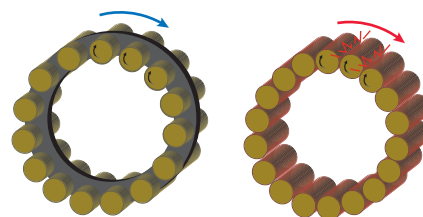

Caged vs. Uncaged Rollers

Low-friction efficiency for fast trim and release

- Center cage keeps Torlon® roller bearings separated and parallel to reduce friction.
- Captive Delrin® ball bearings carry side loads.



**SAFARI
TECH
TEAM**

Which Block do I need?



Shackle blocks lock in two directions or swivel to keep line from twisting

- Set screw allows shackle to be fixed or to swivel.



Soft-attach options

- Loop or lash through sheave center instead of block head.
- Sheave center carries primary load, allowing a smaller, lighter weight block.



Soft-attach options

- Patented Loop blocks have a removable dead end post for attachment to a padeye.



6061-T6 aluminum:
Hard Lube-anodized sideplates, sheave



Delrin UV-stabilized:
Ball bearings



Easy maintenance

- Quick disassembly with hex wrench; minimal number of fasteners; no loose balls or rollers.



Torlon:
Caged roller bearings

Materials
For properties see pages 16-17.

57 mm Blocks

About Black Magic Air blocks: see feature pages at beginning of this section.



3226
3215

KM32fc, 9.82 m (32.2'), VPLP design, Magma Composites © Skymy



Low-load blocks have red isolators. They use Tolorn® rollers and 316 stainless steel shackles. Standard blocks have 17-4 PH stainless headposts.



3214



3216
3229



3217
3228



3218



3219



3227



3386

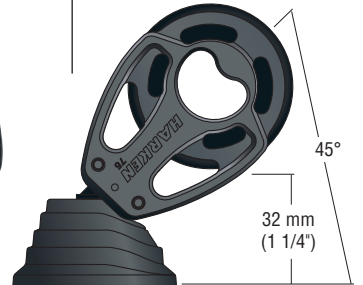

3227

Tolorn is a registered trademark of Solvay Advanced Polymers, L.L.C.

Part No.	Description	Sheave Ø		Length		Weight		Shackle pin Ø		Max line Ø		Maximum working load		Breaking load	
		in	mm	in	mm	oz	g	in	mm	in	mm	lb	kg	lb	kg
3214	Single loop**	2 1/4	57	3	76	3.23	92			7/16	12	2500	1134	5000	2268
3215	Single/swivel	2 1/4	57	4 11/16	119	5.36	152	1/4	6	7/16	12	2500	1134	5000	2268
3216	Single/swivel/becket	2 1/4	57	5 1/2	140	5.86	166	1/4	6	7/16	12	2500	1134	5000	2268
3217	Double/swivel	2 1/4	57	5 3/16	132	11.86	336	5/16	8	7/16	12	3600	1633	7200	3267
3218	Double/swivel/becket	2 1/4	57	6	152	12.43	352	5/16	8	7/16	12	3600	1633	7200	3267
3219	Triple/swivel	2 1/4	57	5 3/16	132	13.34	378	5/16	8	7/16	12	4850	2200	9700	4400
3226	Single/swivel/low-load	2 1/4	57	4 11/16	119	5.44	154	1/4	6	7/16	12	1655	750	3300	1500
3227	Stand-up*	2 1/4	57	4 1/2	114	7.04	200	1/4	6	7/16	12	2500	1134	5000	2268
3228	Double/swivel/low-load	2 1/4	57	5 3/16	132	12.05	342	5/16	8	7/16	12	2755	1250	5510	2500
3229	Single/swivel/low-load/becket	2 1/4	57	5 1/2	140	5.95	169	1/4	6	7/16	12	1655	750	3300	1500
3386	Double loop**	2 1/4	57	3	76	5.93	168			7/16	12	2500	1134	5000	2268

*Includes padeye. 6 mm (1/4") fastener circle: 37 mm (1 15/32"). **Loop not included. See page 85.

75 mm Blocks

About Black Magic Air blocks: see feature pages at beginning of this section.



3230



DNA F4 Catamaran, 14.2 m (46.7') © DNA Performance Sailing



The low-load block has a red isolator. It uses Delrin® ball bearings, with a 17-4 PH stainless headpost and 316 stainless steel shackles.



3244

72 mm
(2 13/16")

45°

43 mm
(1 11/16")

75 mm
(2 15/16")



3231
3243

3232

3233

3244

3241

3242

Delrin is a registered trademark of E. I. du Pont de Nemours and Company or its affiliates.

Part No.	Description	Sheave Ø		Length		Weight		Shackle pin Ø		Max line Ø		Maximum working load		Breaking load	
		in	mm	in	mm	oz	g	in	mm	in	mm	lb	kg	lb	kg
3230	Single loop*	2 15/16	75	3 15/16	100	7.36	209			9/16	14	5000	2268	10000	4536
3231	Single/swivel	2 15/16	75	5 1/8	129	11.68	331	5/16	8	9/16	14	5000	2268	10000	4536
3232	Single/swivel/becket	2 15/16	75	6 3/16	157	12.8	363	5/16	8	9/16	14	5000	2268	10000	4536
3233	Double/swivel	2 15/16	75	5 1/4	134	25.44	721	3/8	10	9/16	14	7500	3402	15000	6804
3241	Spriddle/swivel	2 15/16	75	7 13/16	199	17.76	503	5/16	8	9/16	14	5000	2268	10000	4536
3242	Spriddle/swivel/becket	2 15/16	75	8 7/8	225	18.96	538	5/16	8	9/16	14	5000	2268	10000	4536
3243	Single/swivel/low-load	2 15/16	75	5 1/8	129	11.82	335	5/16	8	9/16	14	3000	1361	6000	2722
3244	Stand-up**	2 15/16	75	5 15/16	151	15.6	442			9/16	14	5000	2268	10000	4536

*Loop not included. See page 85.

**Includes padeye. Uses hole spacing and base dimensions of 627 padeye. Maximum working load decreases at varying angles, refer to page 89.

100 mm Blocks

About Black Magic Air blocks: see feature pages at beginning of this section.



3248



3246



3247



3245



3211



3254



Deadend post for attachment to a closed bail. Loop not included, see page 85.



3254
3211

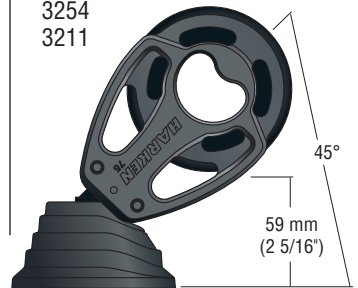

Anka¹, Solaris 64 RS, 19.5 m (64'), naval architect: Javier Soto Acebal © Solaris Yachts

Part No.	Description	Sheave Ø		Length		Weight		Shackle pin Ø		Max line Ø		Maximum working load		Breaking load	
		in	mm	in	mm	oz	g	in	mm	in	mm	lb	kg	lb	kg
3211	Standup/becket**	3 15/16	100	9 1/4	235	32.49	921			5/8	16	7500	3402	15000	6804
3245	Single loop*	3 15/16	100	5 1/16	128	13.09	371			5/8	16	7500	3402	15000	6804
3246	Single/swivel	3 15/16	100	8	203	21.98	623	3/8	10	5/8	16	7500	3402	15000	6804
3247	Single/swivel/becket	3 15/16	100	9 1/2	241	23.82	675	3/8	10	5/8	16	7500	3402	15000	6804
3248	Double/swivel	3 15/16	100	8 15/16	227	45.28	1284	1/2	12	5/8	16	11000	4990	22000	9979
3254	Stand-up**	3 15/16	100	7 11/16	195	31.18	884			5/8	16	7500	3402	15000	6804

*Loop not included. See page 85. **Includes padeye. Uses hole spacing and base dimensions of 648 padeye, refer to page 89.

125 mm & 150 mm Blocks

About Black Magic Air blocks: see feature pages at beginning of this section.



The center becket provides block with additional stiffness for deadending purchases.



3261

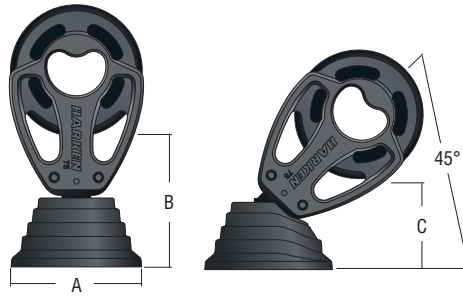

Stand-Up Blocks

Part No.	A		B		C	
	in	mm	in	mm	in	mm
3261	3 21/32	93	4 3/16	106	2 1/4	57
3266	3 3/4	95	5 3/16	132	3 5/8	92



Kinina, Swan 78, 23.99 m (78.70'), Germán Frers design © Nautor Swan



3255

3256

3262

3266

3267
3268

Part No.	Description	Sheave Ø		Length		Weight		Shackle pin Ø		Max line Ø		Maximum working load		Breaking load	
		in	mm	in	mm	oz	g	in	mm	in	mm	lb	kg	lb	kg
125 mm															
3255	Single loop*	4 15/16	125	6	163	23.78	674			3/4	19	11000	4990	22000	9979
3256	Single/swivel	4 15/16	125	10	254	37.31	1058	1/2	12	3/4	19	11000	4990	22000	9979
3261	Stand-up**	4 15/16	125	9 1/16	230	44.72	1268			3/4	19	11000	4990	22000	9979
3267	Center becket			2 3/8	60	4.8	136						3667	1663	
150 mm															
3262	Single/swivel	5 15/16	150	12	305	64.9	1840	5/8	16	1	25	15000	6804	30000	13608
3266	Stand-up ‡	5 15/16	150	11 1/8	283	85.34	2419			1	25	15000	6804	30000	13608
3268	Center becket			2 3/4	71	9.44	268						5000	2268	

*Loop not included. See page 85. **Includes padeye. Uses hole spacing and base dimensions of 648 padeye. Maximum working load decreases at varying angles, refer to page 89. ‡ Uses hole spacing and base dimensions of 629 padeye. Maximum working load decreases at varying angles, refer to page 89.

Air Runner Blocks

Runners are used on running backstays of offshore boats to adjust mast bend for different wind conditions.

Integrated sideplate bails and recessed cotter key help produce a smooth design that won't snag lifelines.

Foam padded Block Socks easily install over Air Runner blocks to protect your blocks, deck, and crew.

About Black Magic Air blocks: see feature pages at beginning of this section.



Sideload bearing strips dampen rig vibration.



Block Socks

Block Socks Part No.	Fits
3035	3224/3238/3239
3036	3251/3252
3037	3259/3260
3038	3264/3265

Runner Blocks

Part No.	Description	Sheave Ø		Length		Weight		Clevis pin Ø		Max line Ø		Maximum working load		Breaking load	
		in	mm	in	mm	oz	g	in	mm	in	mm	lb	kg	lb	kg
57 mm															
3224	Single	2 1/4	57	3 3/8	86	4.42	125	3/8	10	1/2	12	2500	1134	5000	2268
75 mm															
3238	Single	2 15/16	75	4 5/8	118	10.16	288	1/2	12.7	9/16	14	5000	2268	10000	4536
3239	Single/becket	2 15/16	75	5 3/4	146	11.2	318	1/2	12.7	9/16	14	5000	2268	10000	4536
100 mm															
3251	Single	3 15/16	100	6 3/16	157	17	481	5/8	15.9	5/8	16	7500	3402	15000	6804
3252	Single/becket	3 15/16	100	7 9/16	193	19.12	542	5/8	15.9	5/8	16	7500	3402	15000	6804
125 mm															
3259	Single	4 15/16	125	7 11/16	195	29.76	844	3/4	19	3/4	19	11000	4990	22000	9979
3260	Single/becket	4 15/16	125	9 1/2	240	33.52	950	3/4	19	3/4	19	11000	4990	22000	9979
150 mm															
3264	Single	5 15/16	150	8 3/4	221	50.64	1436	3/4	19	1	25	15000	6804	30000	13608
3265	Single/becket	5 15/16	150	10 13/16	275	56.72	1608	3/4	19	1	25	15000	6804	30000	13608

Crossover Blocks

Crossover blocks provide a cleaner, more efficient deck. These easy-to-install blocks mount behind the stopper bank on each side of the cabin house and can route any line to the winch on the opposite side. Blocks feature built-in risers and sculpted backing plates. The large, strong bases protect cored decks. Use the 1984 for boats to 11.5 m (38') and the 1981 for boats to 15 m (48').



1984
1981

Part No.	Description	Sheave Ø		Base Ø		Height		Weight		Max line Ø		Maximum working load		Breaking load	
		in	mm	in	mm	in	mm	oz	g	in	mm	lb	kg	lb	kg
1981	Crossover	2 3/16	56	2 5/8	66	1 7/16	36	8	227	7/16	12	3000	1361	6000	2722
1984	Crossover	1 3/4	44	2 1/16	52	1 1/4	32	4.2	119	3/8	10	2000	907	4000	1814

Fastener included.

Teardrop Blocks

Teardrop blocks are ideal as masthead leads and in other applications where limited articulation or direct attachment is desired. When attached to a compatible padeye, teardrop blocks will not hit the deck when lines are slack, but allow enough movement to ensure fairleads when jumping halyards. They are often used on permanent backstays of fractionally rigged boats where the backstay can be spliced directly to the head of the block.

About Black Magic Air blocks: see feature pages at beginning of this section.



3223
3240
3253



Part No.	Description	Sheave Ø		Length		Weight		Clevis pin Ø		Max line Ø		Maximum working load		Breaking load		Use padeye
		in	mm	in	mm	oz	g	in	mm	in	mm	lb	kg	lb	kg	
57 mm																
3223	Padeye/high-load	2 1/4	57	3 3/8	86	3.92	111	5/16	8	3/8	10	2500	1134	5000	2268	627
75 mm																
3240	Padeye	2 15/16	75	4 7/16	113	8.72	247	3/8	10	9/16	14	5000	2268	10000	4536	648/689
100 mm																
3253	Padeye	3 15/16	100	5 13/16	148	16	454	1/2	12.7	5/8	16	7500	3402	15000	6804	

Footblocks

Use footblocks to redirect lines on the deck. Footblocks with lockoffs temporarily secure sheets.

Either metric or imperial flathead fasteners may be used for mounting and are not exposed.

About Black Magic Air blocks: see feature pages at beginning of this section.



3220
3234
3249
3257
3263



3222
3235
3250
3258



3221
3236



3237

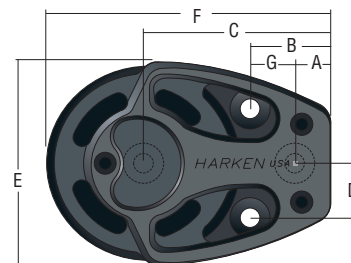

Dimensions

Part No.	A		B		C		D		E		F		G	
	in	mm	in	mm	in	mm	in	mm	in	mm	in	mm	in	mm
3220/3221/3222	3/8	9.5	7/8	22.5	2 1/32	51.5	5/8	16	2 5/16	59	3 5/16	84	1/2	13
3234/3235/3236/3237	15/32	11.5	1 1/8	28.5	2 3/4	70.5	13/16	21	3	77	4 5/16	110	21/32	17
3249/3250	9/16	14.5	1 15/32	37.5	3 21/32	92.5	1 3/32	28	3 15/16	100	5 5/8	143	29/32	23
3257/3258	21/32	17	1 25/32	45	4 7/16	113	1 11/32	34.5	5 1/32	127.5	6 29/32	176	1 3/32	28
3263	13/16	20.5	2 3/32	53.5	5 3/32	129	1 5/8	41	6 1/16	154	8 1/32	204	1 5/16	33

Part No.	Description	Sheave Ø		Length		Height		Weight		Max line Ø		Maximum working load		Breaking load		Fasteners (FH)	
		in	mm	in	mm	in	mm	oz	g	in	mm	lb	kg	lb	kg	in	mm
57 mm																	
3220	Single/high-load	2 1/4	57	3 5/16	84	1	25	4.29	122	7/16	12	2500	1134	5000	2268	4 x 1/4	4 x 6
3221	Single/high-load/lockoff*	2 1/4	57	3 5/16	84	1	25	5.44	154	7/16	12	2500	1134	5000	2268	4 x 1/4	4 x 6
3222	Double/high-load	2 1/4	57	3 5/16	84	1 13/16	46	7.6	215	7/16	12	1655	750	3310	1500	4 x 1/4	4 x 6
75 mm																	
3234	Single	2 15/16	75	4 3/8	111	1 1/4	32	9.76	277	9/16	14	5250	2380	10500	4762	4 x 5/16	4 x 8
3235	Double	2 15/16	75	4 3/8	111	2 1/4	57	17.28	490	9/16	14	3465	1572	6930	3143	4 x 5/16	4 x 8
3236	Single/lockoff*	2 15/16	75	4 3/8	111	1 1/4	32	11.28	320	9/16	14	5250	2380	10500	4762	4 x 5/16	4 x 8
3237	Double/lockoff*	2 15/16	75	4 3/8	111	2 1/4	57	20.24	574	9/16	14	3465	1572	6930	3143	4 x 5/16	4 x 8
100 mm																	
3249	Single	3 15/16	100	5 5/8	143	1 5/16	33	19.57	555	5/8	16	7500	3402	15000	6804	4 x 3/8	4 x 10
3250	Double	3 15/16	100	5 5/8	143	2 7/16	62	34.1	967	5/8	16	4950	2250	9900	4500	4 x 3/8	4 x 10
125 mm																	
3257	Single	4 15/16	125	6 15/16	176	1 11/16	43	34.29	972	3/4	19	11000	4990	22000	9979	4 x 1/2	4 x 12
3258	Double	4 15/16	125	6 15/16	176	2 13/16	71.5	60.35	1711	3/4	19	7260	3292	14520	6585	4 x 1/2	4 x 12
150 mm																	
3263	Single	5 15/16	150	8 1/16	205	1 7/8	48	58.58	1661	1	25	15000	6804	30000	13608	4 x 5/8	4 x 16

*Lockoffs are intended to hold lines temporarily and should not be used in place of line stoppers or clutches.

FlatWinder Powered Block

The Harken FlatWinder powered block is a self-contained, low-profile electrically-powered system for mainsheet traveler adjustment. This powerful block is easy to use and offers sailors huge benefits in mainsail control, giving them the means to quickly depower the rig, and delay reefing when the wind picks up. Like a compact captive winch for the traveler, the FlatWinder is completely self-contained. It operates in both directions allowing the car to move anywhere on the track while also keeping the traveler line off the cockpit floor. Harken recommends installing two space-saving, dual-function Digital System Switches, one button to port, the other to starboard, for activation from both sides of the boat. The block's wide-diameter drive sheave mounts on a sloped base, forming an angle with the sheave top to contain the line so it doesn't push against the block walls. This progressive grip exerts just the right amount of friction to keep wear on the line and components minimal. Plus, the FlatWinder eliminates the need for winches, making the deck cleaner and easier to navigate.

The compact horizontal motor is housed neatly belowdeck and has a maximum working load of 250/500 kg (550/1100 lb). When used with 10 mm line and a 4:1 purchase, this translates into around 1000 kg (2205 lb) of pull with the FlatWinder 250; 2000 kg (4410 lb) with the FlatWinder 500.

A Harken Dual-Function Control Box is included. This integrated load controller and control box conserves space, and with half as many wires as separate systems, is easier to install.

The FlatWinder 250 fits monohulls 15 - 18 m (50 - 60') and catamarans 14 - 15 m (45 - 50'); the FlatWinder 500 fits monohulls 18 - 24 m (60 - 80') and catamarans 15 - 20 m (50 - 70'). It is available in 12V or 24V depending on the boat's electrical system. Switches and circuit breakers are not included.

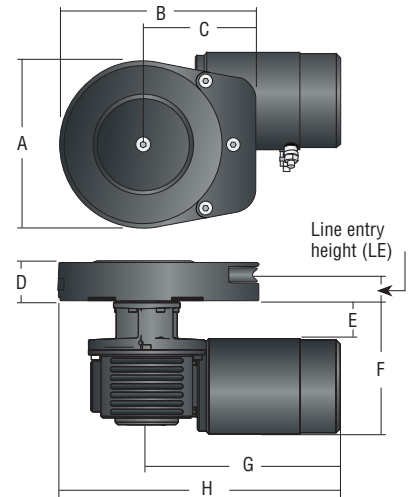

FW250EA12H
FW250EA24H
FW500EA12H
FW500EA24H



Grand Soleil 58, 17.68 m (58'), Cantiere del Pardo © Fabio Taccola / Grand Soleil

Part No.	Description	Weight		Line entry height (LE)		Line Ø		Fastener circle		Fasteners (SH or HH)		Maximum working load		Line speed (no load)	
		lb	kg	in	mm	in	mm	in	mm	mm	mm	lb	kg	ft/min	m/min
FW250EA12H	FlatWinder powered block/12-volt	27.5	12.5	1 1/8	29	3/8	10	4 15/16	125	6 x M6	550	250	115	35	
FW250EA24H	FlatWinder powered block/24-volt	27.5	12.5	1 1/8	29	3/8	10	4 15/16	125	6 x M6	550	250	115	35	
FW500EA12H	FlatWinder powered block/12-volt	49.6	22.5	1 1/8	29	3/8	10	6 5/16	160	6 x M6	1100	500	85	26	
FW500EA24H	FlatWinder powered block/24-volt	49.6	22.5	1 1/8	29	3/8	10	6 5/16	160	6 x M6	1100	500	105	32	

Dimensions

Part No.	A		B		C		D		E		F		G		H	
	in	mm	in	mm	in	mm	in	mm	in	mm	in	mm	in	mm	in	mm
FW250EA12H	7 9/16	192	8 7/8	226	5 1/8	130	1 13/16	45	1 3/4	43	6 1/8	155	8 15/16	227	12 11/16	322
FW250EA24H	7 9/16	192	8 7/8	226	5 1/8	130	1 13/16	45	1 3/4	43	6 1/8	155	8 15/16	227	12 11/16	322
FW500EA12H	9 1/2	242	10 3/4	273	6	152	2 1/16	53	2 13/16	71	9 1/8	231	14 5/16	363	19 1/16	484
FW500EA24H	9 1/2	242	10 3/4	273	6	152	2 1/16	53	2 13/16	71	9 1/8	231	14 5/16	363	19 1/16	484

Stainless Steel Cruising ESP Blocks

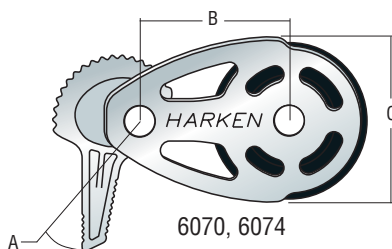
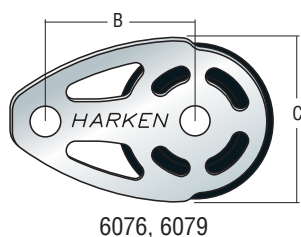

Dimensions

Part No.	A		B		C	
	in	mm	in	mm	in	mm
6070	1 31/32	50	2 5/32	55	2 1/4	57
6074	2	51	2 1/2	63	2 29/32	74
6076			2 5/32	55	2 1/4	57
6079			2 1/2	63	2 31/32	75

Part No.	Description	Sheave Ø		Length		Weight oz	Weight g	Clevis/shackle pin Ø		Max line Ø		Maximum working load		Breaking load‡		Max lockoff load		Fasteners (FH)		
		in	mm	in	mm			in	mm	in	mm	lb	kg	lb	kg	lb	kg	in	mm	
57 mm																				
6068	Single/swivel	2 1/4	57	5 1/2	140	11	312	5/16	8	5/8	16	2205	1000	4409	2000					
6069	Teardrop mast collar	2 1/4	57	3 11/16	93.5	7	198	5/16	8	5/8	16	2205	1000	4409	2000					
6070	Single foot/lockoff*‡	2 1/4	57	3 3/4	132	9	255			5/8	16	2205	1000	4409	2000	650	295	3/8	10	
6076	Footblock‡	2 1/4	57	3 3/4	95	7	198			5/8	16	2205	1000	4409	2000			3/8	10	
6089	Single/swivel/becket	2 1/4	57	6 11/16	170	12.5	354	5/16	8	5/8	16	2205	1000	4409	2000					
75 mm																				
6072	Single/swivel	3	75	6 1/4	159	19	539	5/16	8	3/4	19	3500	1587	7000	3175					
6073	Teardrop mast collar	3	75	4 5/8	117	16	454	5/16	8	3/4	19	3000	1361	6000	2722					
6074	Single foot/lockoff*‡	3	75	4 3/8	111	17	482			3/4	19	3500	1587	7000	3175	750	340	3/8	10	
6079	Footblock‡	3	75	4 1/2	114	16	454			3/4	19	3500	1587	7000	3175			3/8	10	
6080	Fiddle	3:1	13/16	75:46	8 3/8	213	24	680	5/16	8	3/4	19	3500	1587	7000	3175				
6081	Fiddle/becket	3:1	13/16	75:46	9 1/2	241	26.25	744	5/16	8	3/4	19	3500	1587	7000	3175				
6087	Single/swivel/becket	3	75	7 1/4	184	21.25	602	5/16	8	3/4	19	3500	1587	7000	3175					

Deck Organizers

6075	Stainless steel 3-sheave ‡	1 9/16	40	7 11/16	179	10	284			1/2	12	3000	1361	6000	2722			5/16	8
6071	Stainless steel 3-sheave ‡	2 1/4	57	9 15/16	252	21	595			5/8	16	6000	2722	12000	5442			3/8	10

*Lockoffs are intended to hold lines temporarily and should not be used in place of line stoppers or clutches.

‡If double stacked, upper block/organizer is two-thirds of listed MWL and breaking load.

Megayacht Blocks

Harken Megayacht blocks have an ultralight composite bearing system (ULC) that rides on a heat-treated stainless steel inner race to handle extremely high loads. Snap-fit Torlon® ball bearings carry thrust loads. Sideplates are mirror-polished stainless steel to reflect the traditional beauty of a classic yacht, or hardcoat-anodized 6061-T6 aluminum for strength and corrosion resistance—perfect for performance yachts.

Torlon is a registered trademark of Solvay Advanced Polymers L.L.C.

C14457
C14040
C14196
C13771



C14584
C14696
C13911
C14207



Use the hollow inner race as a becket attachment for weight reduction.

HC8670
HC8657
HC8639
HC8635



HC9077
HC9082
HC9087
HC9092



HC8667
HC8640
HC8633
HC8631

HC9078
HC9083
HC9088
HC9093

HC8673
HC8674
HC8675
HC8932



HC9076
HC9081
HC9086
HC9091

C12236
C12237
C12238
C12239



C12242
C12243
C12244
C12245

100, 125, 150 & 175 MM

Stainless Steel Part No.	Aluminum Part No.	Description	Specifications	Imperial	Metric
75 mm					
HC9985		Swivel block	Sheave Ø: Max line Ø: Maximum working load: Breaking load:	2 15/16"	75 mm
HC9986		Stand-up block		9/16"	14 mm
HC9987		Swivel block/becket		5000 lb	2268 kg
HC9990		Teardrop		10000 lb	4536 kg
HC10041		Single footblock			
100 mm					
HC9076	HC8673	Stand-up block	Sheave Ø: Max line Ø: Maximum working load: Breaking load:	3 15/16"	100 mm
HC9077	HC8670	Swivel block		5/8"	16 mm
HC9078	HC8667	Teardrop		11025 lb	5000 kg
C14584	C14457	Single footblock/compact		22050 lb	10000 kg
C12242	C12236	Stud mastbase block			
125 mm					
HC9081	HC8674	Stand-up block	Sheave Ø: Max line Ø: Maximum working load: Breaking load:	4 15/16"	125 mm
HC9082	HC8657	Swivel block		3/4"	19 mm
HC9083	HC8640	Teardrop		15435 lb	7000 kg
C14696	C14040	Single footblock/compact		30870 lb	14000 kg
C12243	C12237	Stud mastbase block			
150 mm					
HC9086	HC8675	Stand-up block	Sheave Ø: Max line Ø: Maximum working load: Breaking load:	5 15/16"	150 mm
HC9087	HC8639	Swivel block*		1"	25 mm
HC9088	HC8633	Teardrop		22050 lb	10000 kg
C13911	C14196	Single footblock/compact		44100 lb	20000 kg
C12244	C12238	Stud mastbase block			
175 mm					
HC9091	HC8932	Stand-up block	Sheave Ø: Max line Ø: Maximum working load: Breaking load:	6 7/8"	175 mm
HC9092	HC8635	Swivel block**		1"	25 mm
HC9093	HC8631	Teardrop		33075 lb	15000 kg
C14207	C13771	Single footblock/compact		66150 lb	30000 kg
C12245	C12239	Stud mastbase block			



HC9985



HC9986



HC9987



HC9990



HC10041

75 MM

*Maximum working load limited by shackle: 8800 kg; 19405 lb.

**Maximum working load limited by shackle: 12800 kg; 28225 lb.

Contact Harken East for custom sizes.

Mastbase Halyard Lead Blocks

Fixed Mastbase Leads

Low-profile mastbase halyard lead blocks are lightweight and can be grouped in a small area at the mastbase. Flared cheeks prevent chafe on the halyards.

The high-load bearing system has a PTFE composite bushing and sideload balls. The sheave is hardcoat-anodized aluminum for additional strength.

Teardrop Mast Collar Blocks

These teardrop mast collar blocks coordinate well with any Harken blocks in a deck layout. Sheaves feature sleeve bearings to handle high static loads and are ideal for halyards. Use the blocks for direct attachment to padeyes, mast collar posts, perforated mast collars, or in mastbase situations where leads might change.



1986

1988
1990
3123
3192

448

FIXED MASTBASE LEADS



Saga, Saare 38.2, 11.4 m (38'), naval architect: Karl-Johan Strahlmann © Saare Yachts OÜ



6107

6050
6056
60576095
6096
6097
60986096
6097
6098

TEARDROP MAST COLLAR BLOCKS

Part No.	Description	Sheave Ø		Width		Length		Height		Weight		Max line Ø		Maximum working load		Breaking load		Fasteners required
		in	mm	in	mm	in	mm	in	mm	oz	g	in	mm	lb	kg	lb	kg	
Fixed Halyard Leads																		
448	Halyard lead block	1 1/2	38	7/8	22	2	51	2 1/8	53	2.1	60	3/8	10	300	136	600	272	2
1986	Halyard lead*	1 3/4	44	7/8	22	2 7/8	73	2 1/4	57	3.36	95	3/8	10	750	340	1500	680	2
1988	Mastbase/teardrop**	2 1/4	57	1 3/8	35	3 3/16	81	2 7/8	73	6.2	175	3/8	10	2500	1136	5000	2273	3
1990	Mastbase/teardrop***	3	76	1 1/4	32	3 13/16	97	3 3/4	95	11.5	326	1/2	12	5000	2273	10000	4545	4
3123	Mastbase/teardrop†	4	102	1 5/8	41	5 1/8	130	5 1/8	130	24.9	708	11/16	18	11000	4990	22000	9980	2
3192	Mastbase/teardrop	4	102	1 15/16	50	4 7/8	175	5 1/8	130	35.25	1000	5/8	16	13227	6000	26455	12000	3
Teardrop Mast Collar Blocks																		
6050	Teardrop mast collar	2 1/4	57			3 11/16	93.5			4.3	122	5/8	16	2100	850	4190	1900	
6056	Teardrop mast collar	2 15/16	75			4 5/8	117			7.8	221	3/4	19	3000	1361	6000	2721	
6057	Teardrop padeye block	2 15/16	75			4 11/16	119			8.4	238	3/4	19	3500	1587	7000	3175	
6065	Teardrop padeye block	2 1/4	57			3 11/16	93.5			4.5	128	5/8	16	2100	850	4190	1900	
6095	Teardrop mast collar/low-load	2 1/4	57			3 1/2	89			4	113	5/8	16	1650	748	3300	1497	
6096	Narrow teardrop mast collar	2 1/4	57	2 5/16	59	3 1/2	89			3.3	94	3/8	10	1650	748	3300	1497	
6097	Narrow teardrop mast collar	2 1/4	57	2 5/16	59	3 1/2	89			3.5	99	3/8	10	1650	748	3300	1497	
6098	Narrow teardrop mast collar	3	75	3 1/32	77	4 7/16	113			6.4	181	1/2	12	2500	1134	5000	2268	
6107	Teardrop mast collar	1 9/16	40			2 19/32	65.5			2.2	64	1/2	12	1250	567	2500	1134	

*6 mm (1/4") RH. **6 mm (1/4") FH. ***8 mm (5/16") FH. †16 mm (5/8") HH.

Over-the-Top Blocks

Over-the-top blocks lead lines aft over cabin houses, coamings, and splashguards. They feature high-load sheaves and come in single, double, and triple configurations.



Part No.	Description	Sheave Ø		Width		Length		Height		Weight		Max line Ø		Maximum working load		Breaking load		Fasteners required
		in	mm	in	mm	in	mm	in	mm	oz	g	in	mm	lb	kg	lb	kg	
3002	Single over-the-top*	2 1/4	57	1 3/8	35	3 1/4	83	3 1/4	83	6.4	181	3/8	10	2500	1136	5000	2272	2
3003	Double over-the-top*	2 1/4	57	2 7/16	62	3 1/4	83	3 1/4	83	12.2	346	3/8	10	2500	1136	5000	2272	4
3004	Triple over-the-top*	2 1/4	57	3 1/2	89	3 1/4	83	3 1/4	83	18.1	513	3/8	10	2500	1136	5000	2272	6
C8322	Single over-the-top**	1 3/4	45	1 7/16	36	3 1/16	78	3 7/32	82	5.6	159	1/2	12	2500	1136	5000	2272	2
C8624	Single over-the-top**	2 15/16	75	1 11/16	43	4	101	4	101	18.5	526	9/16	14	5000	2272	10000	4536	3

*6 mm (1/4") FH. **Contact Harken to request quote and lead time.

Flip-Flop Blocks

Low-profile Flip-Flop blocks are lightweight and can be used for various leads on your boat including halyard, mainsheet, and spinnaker sheet leads.

The Flip-Flop block has aluminum hardcoat-anodized sideplates and features Hard Lube-anodized aluminum sheaves for strength and corrosion resistance.

High-load Flip-Flop blocks pivot around the line axis to keep line close to the deck. Hinged construction allows variable leads. Lockoff provides a temporary stop to free up winches.



Bénéteau Oceanis 46.1 © Guido Cantini / Bénéteau

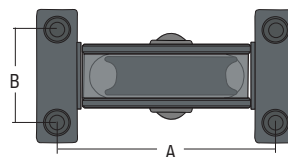

Dimensions

Part No.	Fasteners (SH)		A		B	
	in	mm	in	mm	in	mm
1987/1989	5/16	8	4 15/16	125	1 15/16	50
3122/3194	1/4	6	3 11/16	93.6	1 9/16	39.7

SH cap screw fasteners.

Part No.	Description	Sheave Ø		Width		Length		Height		Weight		Max line Ø		Maximum working load		Breaking load	
		in	mm	in	mm	in	mm	in	mm	oz	g	in	mm	lb	kg	lb	kg
1987	Flip-Flop	3	76	2 7/8	72	6	152	4	100	17.37	493	1/2	12	5000	2273	10000	4545
1989	Flip-Flop/lockoff	3	76	2 7/8	72	6	152	4	100	21.1	598	1/2	12	5000	2273	10000	4545
3122	Flip-Flop	2 1/4	57	2 1/4	57	4 3/8	111	2 7/8	73	9	255	3/8	10	2500	1136	5000	2273
3194	Flip-Flop/lockoff	2 1/4	57	2 1/4	57	4 3/8	111	2 7/8	73	11.2	317.8	3/8	10	2500	1136	5000	2273

High-Load Snatch Blocks

These multipurpose blocks are a must on racing yachts of all sizes. Opening sideplates make them easy to deploy, allowing crew to quickly fasten them wherever needed—perfect for temporary leads, line deflection, and static line functions requiring small adjustments. A strop soft-attach is fixed on one side, but is easily removable on the other. The strop carries the block's primary load and articulates for a fair lead. The Velcro® strap is permanently attached to one sideplate and holds the block securely closed when sideplates are aligned—even under the highest loads. The strap has a broad reflective tab for easier operation with gloves.

Harken composite bearing technology (ULC) ensures sheaves turn smoothly and maintain efficiency under extreme loading. Snap-fit Torton® bearings carry sideloads. An integral headspacer prevents Hard Lube-anodized aluminum sideplates from deflecting and binding. The wide sheave allows a range of line diameters.

Torton is a registered trademark of Solvay Advanced Polymers L.L.C.
Velcro is a registered trademark of Velcro Industries B.V.I.



Sideplate rotates open allowing rigged line to be loaded into block.



A fixed Velcro strap keeps sideplates aligned and securely closed under high loads.

Ladykiller, ClubSwan 50, 15.24 m (50'), Nautor's Swan, naval architect: Juan Kouyoumdjian © Studio Borlenghi



3299

3300

3301

3302

3303

Part No.	Description	Sheave Ø		Length		Weight		Max line Ø		Maximum working load		Breaking load	
		in	mm	in	mm	oz	g	in	mm	lb	kg	lb	kg
3299	2.3T snatch	1.5	38.5	2.5	63	2.96	84	7/16	11	5069	2300	10138	4600
3300	5T snatch	2.2	56	3.4	86	8.89	252	5/8	16	11020	5000	22040	10000
3301	8T snatch	3	75	4.5	114	17.57	498	3/4	18	17632	8000	35264	16000
3302	12T snatch	4	101	5.8	148	36.72	1041	1 3/16	30	26448	12000	52896	24000
3303	15T snatch	4.9	125	6.9	175	58.34	1654	1 3/16	30	33060	15000	66120	30000

V Blocks

The V block delivers another breakthrough in Harken's loop block series for Grand-Prix racers. Harken engineers have simplified the mechanics by combining the axial and thrust bearings into a single bearing set of V-shaped titanium rollers. The result is a strong, lightweight block that offers unmatched efficiency at high loads, while spinning freely at low loads for smooth easing in light air.

Harken V blocks feature titanium sheaves and captive titanium roller bearings, and are available with either 3D-molded carbon or anodized aluminum sideplates. V blocks are easy to disassemble for inspection and maintenance.

Loop or lash through sheave center instead of block head. Sheave carries primary load, allowing a smaller, lighter weight block.



The V block
What's Inside?



V blocks are named for the unique V-shaped angled rollers that handle both axial and thrust loads.



Designed for easy maintenance, blocks have captive rollers and minimal components; quick disassembly with a hex wrench.

V Blocks



3294

3295

3296

3297

CARBON FIBER



Wide sheave accepts multiple lines for sail changes or a single, high-load larger line that requires a small deflection.



© Bill Faude



3294AL
3295AL
3296AL
3297AL
3363AL

3370AL
3371AL
3372AL

3362AL
3366AL
3367AL
3368AL
3369AL

ALUMINUM

ALUMINUM WIDE SHEAVE

Part No.	Description	Sheave Ø		Length		Weight		Max line Ø		Maximum working load		Breaking load	
		in	mm	in	mm	oz	g	in	mm	lb	kg	lb	kg
3294	1.5T single loop	1 7/8	47	2 19/32	66	2.86	81	11/32	9	3300	1500	6600	3000
3295	3.0T single loop	2 3/16	56	3	77	3.99	113	7/16	11	6600	3000	13200	6000
3296	5.0T single loop	2 7/16	62	3 5/16	84	6.31	179	1/2	13	11000	5000	22000	10000
3297	6.5T single loop	3 1/4	82	4 3/16	107	12.84	364	5/8	16	14300	6500	28600	13000
3294AL	1.5T single loop	1 7/8	47	2 9/16	65	3.35	95	11/32	9	3300	1500	6600	3000
3295AL	3.0T single loop	2 3/16	56	3	77	4.37	124	7/16	11	6600	3000	13200	6000
3296AL	5.0T single loop	2 7/16	62	3 5/16	84	6.74	191	1/2	13	11000	5000	22000	10000
3297AL	6.5T single loop	3 1/4	82	4 3/16	107	14.11	400	5/8	16	14300	6500	28600	13000
3362AL	5.0T single loop/wide sheave	2 7/16	62	3 3/4	94	9.17	260	2 x 1/2	2 x 13	11000	5000	22000	10000
3363AL	8.0T single loop	4 3/32	104	5 3/8	136	25.12	712	1 1/16	18	17600	8000	35200	16000
3366AL	1.5T single loop/wide sheave	1 7/8	47	2 11/16	68	4.27	121	2 x 5/16	2 x 8	3300	1500	6600	3000
3367AL	3.0T single loop/wide sheave	2 3/16	56	3	77	6.24	177	2 x 3/8	2 x 10	6600	3000	13200	6000
3368AL	6.5T single loop/wide sheave	3 1/4	82	4 5/8	118	18.13	514	2 x 5/8	2 x 16	14300	6500	28600	13000
3369AL	8.0T single loop/wide sheave	4 3/32	104	5 9/16	141	31.57	895	2 x 11/16	2 x 18	17600	8000	35200	16000
3370AL	12T single loop	4 3/4	120	6 3/16	157	33.23	942	7/8	22	26400	12000	52800	24000
3371AL	16T single loop	5 5/16	135	6 15/16	175	42.54	1206	1 1/32	26	35200	16000	70400	32000
3372AL	20T single loop	6 1/8	155	7 27/32	199	62.72	1778	1 3/16	30	44000	20000	88000	40000

Loops not included.



Drew Kosmoski Mechanical Engineer

Harken Since 2011

A typical day for Harken custom engineer Drew Kosmoski begins with

an early email check to see if customers – many European – need his help. He tries to respond before the end of their workday. He then designs, inspects new parts in Harken's custom machine shop to assure they are shipment-ready and evaluates equipment in Harken's Pewaukee test lab.

Drew, who has been with Harken since 2011, says one of the perks of his job is being able to get out of the office and see what he's designed, in use.

"I've been able to go to the America's Cup in San Francisco, a Volvo stopover, as well as Megayacht regattas in Spain and Italy," he says. "I've also been challenged while working on the V block line, as well as parts for the J Class yachts like *Svea* and *Hanuman*. It's also been interesting working on Harken Industrial's large oceanographic research blocks."

A big part of Drew's job is developing tests for Harken products (often, breaking them) to make sure they withstand required loads.

Drew is a sailor. When he's not on the water you'll find him behind the wheel of his Porsche or off-roading in his Jeep.

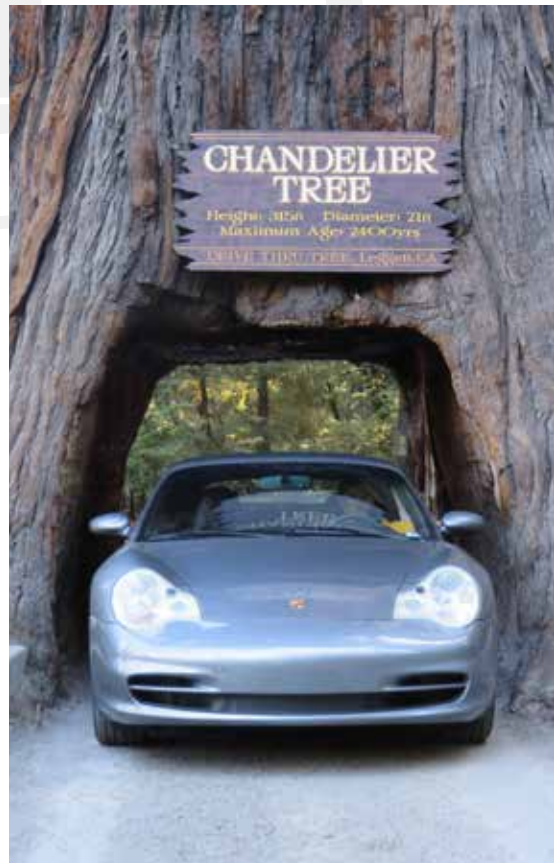

COMPLEMENTARY HARDWARE

NEW FOR 2020



V Sheaves
SEE PAGE 80





ClubSwan 36, 11 m (36'), naval architect: Juan Kouyoumdjian
© Nautor's Swan/Studio Borlenghi/Stefano Gattini



BALL BEARING CAM CLEATS

Multiple rows of high-load ball bearings and precise V-shape reduce friction, allowing Harken cam cleats to activate with the snap of the wrist. No need for draw-through cleating: a downward flick snaps the sheet into the cam and stays exactly where you put it. Flick up and the cleat releases instantly, even under high loads. Harken cleats are the only cleats that engage under maximum line tension.



Cams engage/release loaded line instantly for precise sail control

- Multiple rows of UV-stabilized ball bearings reduce friction.
- Cam horns and V-shape for easy line entry.

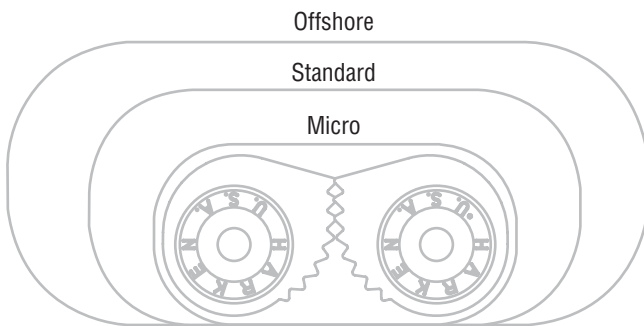

Three sizes in lightweight, wear-resistant materials

- Micro, standard, offshore sizes.
- Cam-Matic: Hard Lube-anodized aluminum, or mirror-polished stainless steel.
- Carbo-Cam: UV-stabilized fiber-reinforced Carbo composite.



Rebuild your
Harken 150
Cam-Matic®
Cam Cleat

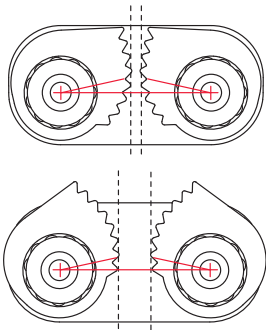

Protective tooth design holds line securely

- Rounded teeth reduce line wear, squeezing rather than cutting the line.
- Each line size held by the most number of teeth.



Full range of accessories

- Flairleads, fairleads, adapter plate, wedge kits, risers, and bases.



Materials
For properties
see pages 16-17.



316 Stainless steel:
Mirror-polished



6061-T6 aluminum:
Hard Lube-anodized



Carbo composite:
UV-stabilized



Delrin® UV-stabilized:
Ball bearings

Ball Bearing Cam Cleats

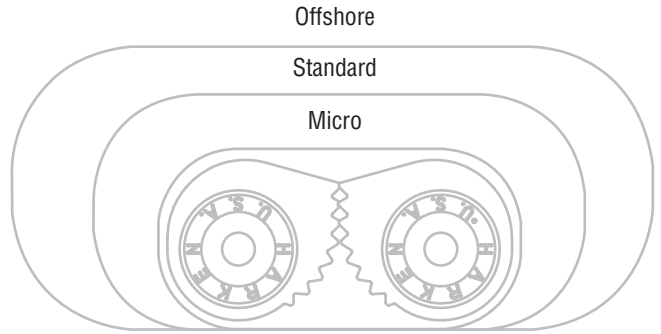
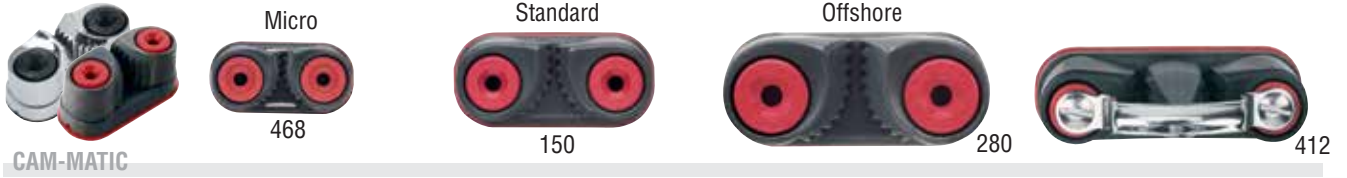

Part No.	Description	Height		Length		Width		Weight		Line Ø				Fastener spacing		Maximum working load		Breaking load		Pawls
		in	mm	in	mm	in	mm	oz	g	Min	Max	in	mm	in	mm	lb	kg	lb	kg	
150	Cam-Matic*	1 3/16	30	2 9/16	65	1 1/4	32	2.5	71	1/8	3	1/2	12	1 1/2	38	300	136	750	340	Aluminum
280	Offshore Cam-Matic‡	1 7/16	37	3 3/8	85	1 1/2	38	5.25	148	1/4	6	5/8	16	2 1/16	52	500	227	1000	454	Aluminum
468	Micro Cam-Matic**	7/8	22	1 7/8	48	15/16	24	0.93	26	3/32	2	1/4	6	1 1/16	27	200	91	400	181	Aluminum
491	Offshore Cam-Matic SS ‡	1 7/16	37	3 3/8	85	1 1/2	38	13.4	380	1/4	6	5/8	16	2 1/16	52	500	227	1000	454	Stainless steel
365	Carbo-Cam*	1 3/16	30	2 9/16	65	1 1/4	32	1.44	42	1/8	3	3/8	10	1 1/2	38	200	91	500	227	Plastic carbon-matrix
412	Double Cam-Matic*	2 1/16	53	3 17/32	81	1 1/4	32	4.5	126	5/16	8	3/8	10	2 7/16	62	500	227	750	340	Aluminum
471	Micro Carbo-Cam**	7/8	22	1 7/8	48	15/16	24	0.67	19	1/8	3	1/4	6	1 1/16	27	150	68	300	136	Plastic carbon-matrix

*#10 (5 mm) FH fasteners. **#8 (4 mm) RH fasteners. ‡6 mm (1/4") FH fasteners.

Cam Kits



Part No.	Description	Cam	Wedge	Fairlead	Weight		Part No.	Description	Cam	Wedge	Fairlead	Weight	
					oz	g						oz	g
Micro Kits							Standard Kits						
472	Carbo-Cam/wedge/wire fairlead	471	297	475	1.2	33	326	Carbo-Cam/wire fairlead	365		298	2	54
469	Cam-Matic/wire fairlead	468		475	1.2	33	327	Cam-Matic/wire fairlead	150		298	3	85
473	Carbo-Cam/wire fairlead	471		475	0.9	26	458	Carbo-Cam/X-Treme Angle Fairlead	365		375	3.36	98
474	Carbo-Cam/X-Treme Angle Fairlead	471		476	1.7	47	459	Cam-Matic/X-Treme Angle Fairlead	150		375	4.42	127
470	Cam-Matic/X-Treme Angle Fairlead	468		476	1.9	55	496	Cam-Matic/Fast Release Fairlead	150		494	4.85	137
498	Cam-Matic/Fast Release Fairlead	468		495	1.8	52	497	Carbo-Cam/Fast Release Fairlead	365		494	3.53	100
499	Carbo-Cam/Fast Release Fairlead	471		495	1.5	43							

Cam Cleave Accessories

Use these accessories to adapt our cleats for many applications, such as cleaning up cockpit controls with color-coding or leading a line cleanly to a cleat.

The 475 Micro Cam-Matic cleat and 298 wire fairleads guide line into the entrance side of the cleat, maintaining a low profile and holding line close to the cleat.

Use the 475 with the 468 and 471 Micro Cam-Matic cleats. Use the 298 wire fairlead with the 150 Cam-Matic and 365 Carbo-Cam cleats.

The 494 and 495 Fast Release Fairleads feature low-friction, angled stainless steel line guides on the exit side of the cleat. The angled lead keeps the line away from the cam to eliminate unexpected recleats during maneuvers. Use for fast spinnaker take-downs during mark roundings—anywhere fast release is crucial. Harken Cam-Matic Fairleads are made of tough, abrasion-resistant composite.

Use the 495 with 468 and 471 Micro Cam-Matic cleats; the 494 fairlead with the 150 Cam-Matic and 365 Carbo-Cam cleats.

The 375 X-Treme Angle Fairlead uses low-friction stainless steel line guides on the exit side of the cleat. This allows crew to release and recleat at angles up to 90 degrees to the cleat without centering the line. Perfect for cabintop controls and adjusting deck cleats from the rail. A must for fine-tuning Laser outhaul and cunningham controls. Harken Cam-Matic Fairleads are made of tough, abrasion-resistant composite. Use the 476 X-Treme Angle Fairlead with the 468 and 471 Micro Cam-Matic cleats; the 375 X-Treme Angle Fairlead with the 150 Cam-Matic and 365 Carbo-Cam cleats.

The 424 and 425 low-profile, top-mounted Fairleads can also be used to guide lines. They feature stainless wearguards and are available in various colors for color coding cams. Use the 424 with the 468 and 471 Micro Cam-Matic cleats. Use the 425 with the 150 Cam-Matic and 365 Carbo-Cam cleats.

Wedge kits and risers improve the angle of your cams. A range of eyestraps holds line at the cleat and provides fair leads.



Cleat and uncleat at angles up to 90 degrees.

Stainless steel loop provides low-friction turning post.

Base plate ensures optimal cleating height.

Ideal for Laser outhaul/cunningham controls.



Part No.	Description	Height above cam		Height		Length		Width		Weight		Fastener spacing		Fits
		in	mm	in	mm	in	mm	in	mm	oz	g	in	mm	
Micro														
281.PAIR	Eyestraps (pair)	1/2	12			1 7/16	36	7/16	11	.16	4.5	1 1/16	27	468/471
475	Wire fairlead			15/16	23	1 7/8	48	15/16	24	.29	8	1 1/16	27	468/471
293	Flat cam riser			5/8	16	1 7/8	48	15/16	24	.5	14	1 1/16	27	468/471
294	15° angled micro cam riser			3/4	19	1 7/8	48	15/16	24	.75	21	1 1/16	27	468/471
297	Cam wedge kit					1 7/8	48	15/16	24	.16	5	1 1/16	27	468/471
476	X-Treme Angle Fairlead	7/8	22	1 7/16	37	1 5/16	33	2	51	1	29	1 1/16	27	468/471
424	Flairlead††	7/16	11			1 5/8	41	5/8	16	.13	3.5	1 1/16	27	468/471
495	Fast Release Fairlead	9/16	14	1 9/16	40	1 5/16	33	1 15/16	49	.92	26	1 1/16	27	468/471
Standard														
145	Cam wedge kit					2 9/16	65	1 1/4	32	1	28	1 1/2	38	150/365
201.PAIR	Low-profile eyestraps (pair)	3/8	10			1 7/8	48	7/16	11	.16	4.5	1 1/2	38	150/365
295	Flat cam riser			1	24	2 9/16	65	1 1/4	32	1.5	38	1 1/2	38	150/365
296	15° angled cam riser			1 1/16	27	2 9/16	65	1 1/4	32	1.25	35	1 1/2	38	150/365
298	Wire fairlead			1 1/4	32	2 9/16	65	1 1/4	32	.5	14	1 1/2	38	150/365
375	X-Treme Angle Fairlead‡	15/16	24	2 1/4	57	1 13/16	46	2 9/16	65	1.92	56	1 1/2	38	150/365
425	Flairlead††	5/8	16			2 3/16	56	1 3/16	21	.25	7	1 1/2	38	150/365
438	Cam adapter plate			9/16	14	3	76	1 7/16	36	2.5	71	1 1/2	38	150/365
494	Fast Release Fairlead	3/4	19	2 3/32	53	1 13/16	47	2 5/8	67	2.12	60	1 1/2	38	150/365
Offshore														
282.PAIR	Large eyestraps (pair)	15/16	23			2 13/16	71	3/4	19	.8	23	2 1/16	52	280
283	Offshore cam wedge kit					3 3/8	85	1 1/2	38	1.5	43	2 1/16	52	280
137.PAIR	Eyestraps (pair)	3/4	19			2	51	9/16	14	.32	9	1 1/2	38	150/365

†Max line Ø: 10 mm (3/8"). ††Indicate color: BL (blue), Y (yellow), G (green), B (black), R (red).

Cam Cleet Accessories



Micro



297

Standard



145

Offshore



283

Wedge kits and risers are available to improve cam angles. Underdeck shims are included with angled risers and wedges for easy mounting.



424
425

Lightweight, fiber-reinforced Fairleads feature stainless wearguards for long life and are available in various colors for color-coding cams.



294



296



293



295

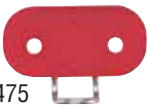

475



298



476



375



495



494



424



425



281.PAIR



137.PAIR



201.PAIR



282.PAIR



438

The 438 adapter plate is perfect for use on masts and booms. It raises the cleat off the mast to improve the cleating angle and control.

Cam Bases

Use cam swivel bases when leads must rotate to face the trimmer.

Ball bearing swivel bases feature dual rows of Delrin® ball bearings that swivel freely even under high loads. Bases include stand-up springs and a U-Adaptor to accept a variety of appropriate blocks.

The 144 is the standard configuration with a tall arm. It is ideal for mounting in the cockpit or for use on larger keelboats and small offshore boats that use 76 mm (3") plastic blocks. The low-profile 205 is used when installation is at deck level and when smaller blocks are used. The 1574 accepts Midrange blocks.

The 216 features a second cleat for lines led vertically through the base of the swivel. It is frequently used to combine vang or backstay controls in the same swivel base that handles the mainsheet.

The 240, 241 and 639 are simple swivel bases for main and jib sheets on very small boats or for control lines on boats of all sizes.

The 402 and 403 are fitted with a double Cam-Matic cleat for use in 2-speed mainsheet systems.

The 462 swivel base with 468 Micro Cam-Matic cleat provides precise cleating. The 16 mm sheaves feature low-friction stainless steel ball bearings to handle high loads, ideal for controls where cleating angles change dramatically. The HSB538 has a 471 Micro Carbo-Cam cleat, and is equipped with a bullseye fairlead instead of sheaves.



Cam-Matic ball bearing cam cleats.

Swivels freely under load.

Stops on base prevent swivel from over-rotating and fouling line.

144 includes adapter for 57 mm and 75 mm Carbo blocks.

Delrin is a registered trademark of E. I. du Pont de Nemours and Company or its affiliates.

Part No.	Description	Height		Weight		Line Ø				Fastener spacing		Maximum working load		Use with
		in	mm	oz	g	Min	Max	in	mm	in	mm	lb	kg	
144	Swivel base/150 Cam-Matic*	5 3/4	146	13	369	1/8	3	1/2	12	3/4	19			57 mm/75 mm/2.25"/3.00"/ratchets
205	Small swivel base/150 Cam-Matic*	4 1/2	114	12	340	1/8	3	1/2	12	3/4	19			57 mm/Big Bullet/Dinghy/2.25"/small ratchets
216	Duocam swivel base/365, 471 Carbo-Cam*	5 3/4	146	16	454					3/4	19			57 mm/2.25"/3.00"/ratchets
238	150 Cam-Matic on plate/bullseye‡	1 5/16	33	4	113	1/8	3	1/2	12	1 1/2, 1	38, 25	300	136	
239	365 Carbo-Cam on plate/bullseye‡	1 5/16	33	3	85	1/8	3	3/8	10	1 1/2, 1	38, 25	200	91	
240	Bullseye swivel base/150 Cam-Matic*	2 7/16	62	7.5	213	1/8	3	1/2	12	1 1/32	26	300	136	
241	Bullseye swivel base/365 Carbo-Cam*	2 7/16	62	6.5	184	1/8	3	3/8	10	1 1/32	26	150	68	
379	471 Micro Carbo-Cam on plate/bullseye‡‡	7/8	22	1.75	50	1/8	3	1/4	6	1 1/16	27	150	68	
402	Small swivel base/412 Cam-Matic*	4 3/8	111	12.75	362	5/16	8	3/8	10	3/4	19			57 mm/2.25" double ratchets
403	Swivel base/412 Cam-Matic*	5 3/4	146	14	398	5/16	8	3/8	10	3/4	19			57 mm/2.25"/3.00" double ratchets
462	Swivel base/468 Micro Cam-Matic/16 mm sheaves	1 13/16	46	4.8	136	1/8	3	1/4	6	1 1/32	26	200	91	
639	Bullseye swivel base/150 Cam-Matic*	1 15/16	75	9.14	259	1/8	3	1/2	12	1 1/32	26	300	136	
1574	Midrange swivel base/280 Cam-Matic**	5 15/16	151	23	652	1/4	6	5/8	16	1 1/16	27			Midrange
HSB538	Swivel base/471 Micro Carbo-Cam/Bullseye	1 13/16	46	3.7	105	1/8	3	1/4	6	1 1/32	26	150	68	

*#10 (5 mm) FH fastener. **6 mm (1/4") FH fastener. ‡#10 (5 mm) RH fastener. ‡‡#8 (4 mm) RH fastener.

Stand-Up Bases

Stand-up bases allow a wide variety of blocks to be held upright, swivel freely, or pivot so lines have a fair lead under load.

Ball-and-Socket Swivel Bases

The ball-and-socket design lets blocks articulate up to 45 degrees and swivel freely. The 460 and 461 bases have stainless steel reinforcement plates to handle the high load capacities of 57 mm and 75 mm Carbo blocks. Bases may be fitted with springs, but blocks won't hit the deck without them.

Stanchion Mount Base

The 061 stanchion mount base attaches blocks to 22 mm or 25 mm (7/8" or 1") stanchions or pulpits and is often used to lead furling lines to the cockpit. Allows blocks to swivel and pivot for fairleads.

Midrange Cruising ESP Stand-Up

Use the 1634 stand-up base with Midrange blocks and 57 mm or 75 mm Cruising ESP blocks. Block headpost fits into socket without shackle. The low-profile design is ideal for mastbase and halyard lead blocks.

Springs

Springs support blocks on padeyes, eyestraps, bases, and traveler cars, and prevent blocks from hitting the deck.

Stand-Up Boots

Made of durable, flexible PVC, stand-up boots hold blocks up without snagging lines. The 369 fits 40 mm and 57 mm Carbo and Black Magic blocks. The 370 fits 75 mm Carbo blocks.

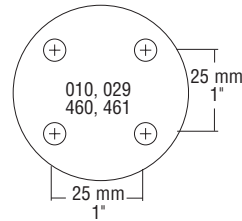
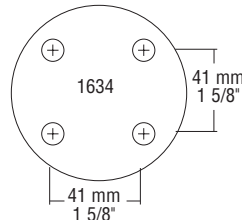

1634: Midrange and ESP Cruising block stand-up base

Swivels and pivots freely

Blocks will not hit deck



1634



460
461



061



369
370



077

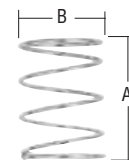

097.PAIR
071.PAIR
1603.PAIR



010

Bases

Part No.	Description	Height		Weight		Base Ø		Inside socket Ø		Pin Ø		Maximum working load		Breaking load		Use with
		in	mm	oz	g	in	mm	in	mm	in	mm	lb	kg	lb	kg	
010	Ball/socket*	1 3/4	44	3	85	2 1/8	54	3/8	10	3/16	5	400	181	1300	590	2.25"/Little Fiddle/ratchets
061	Stanchion mount base	1 1/4	32	2	57			3/8	10	3/16	5	350	159			Bullet/Big Bullet/2.25"/ratchets
460	Ball/socket/high-load*	1 3/4	44	4	113	2 1/8	54	3/8	10	3/16	5	800	363	2500	1134	57 mm Carbo
461	Large ball/socket/high-load*	2	51	4.5	128	2 1/8	54	7/16	12	1/4	6	1000	454	2500	1134	75 mm Carbo
1634	Midrange/Cruising ESP stand-up**	1 15/16	49	9	255	2 7/8	73	9/16	15	5/16	8	3500	1588	7000	3175	Midrange/Cruising ESP

Base accessories

Part No.	Description	Weight		A		B		Shackle pin Ø	
		oz	g	in	mm	in	mm	in	mm
071.PAIR	Stand-up spring (pair)	.32	9.1	2	51	7/8	22		
077	DN adaptor	2.4	69	1/4	32	11/16	17	3/16	5
097.PAIR	Small stand-up spring (pair)	.13	3.7	1	25	3/4	19		
369	Small stand-up boot	.45	12.7	2	51	1 9/16	40		
370	Large stand-up boot	1.1	30.8	2 5/8	67	2 3/16	55		
1603.PAIR	Midrange stand-up spring (pair)	.74	21	2 1/2	64	1 3/8	35		

*#10 (5 mm) FH fasteners. ** 6 mm (1/4") RH fasteners.

Accessories

Accessories are designed to make standard blocks more versatile or fill a special need. Custom products available on website.

Handhold

The 062 handhold is popular on boats like Solings and scows to help hiking crew reenter the boat. It can also be used as a handle for things like engine covers. It has drain holes.



Bullseye Fairlead

Use the 237 and 339 where there is little deflection in the line such as routing a spinnaker pole foregy aft along the cabin house.

Sail Chafe Protectors

Use the 285 to ease genoas over lifelines or past shrouds and to help large roach mainsails clear backstays.

Prefeeder

Use 947 with racing foils or furling systems.

Dinghy Clew Hook

The 433 and 394 dinghy clew hooks are designed for Lasers and other loose-footed dinghies. They install permanently on the boom and allow you to instantly attach and adjust your sail in high wind and waves.



Z420, 2.24 m (13.90'), Laser Performance © Laser Performance

Part No.	Description	A		B		Fastener spacing		Part No.	Description	Weight	
		in	mm	in	mm	in	mm			oz	g
062	Handhold*	5 3/4	146	3 1/2	89			394	Dinghy clew hook/404	1	28.4
237	Bullseye fairlead**	1 1/4	32	1 1/2	38	1	25.4	433	Dinghy clew hook	.65	18.4
285	Sail chafe protector set (2)	2 3/4	70					947	Prefeeder	1	28
339	Micro bullseye fairlead‡	1 1/16	27	3/4	19	.71	18				

*#10 (5 mm) FH fasteners. **#10 (5 mm) RH fasteners. ‡#8 (4 mm) RH fasteners, max line Ø 6 mm (1/4").

Self-Contained Sheaves

Self-contained sheaves are designed for sailors to use in custom applications.

The Micro, Bullet, and Big Bullet sheaves are Delrin with Delrin® ball bearings. They are scored for rope. 16 mm sheaves are Delrin and feature stainless ball bearings that ride in a grooved race. Midrange sheaves come in either Delrin or aluminum for wire.

Wire sheaves are Hard Lube-anodized aluminum that ride on high-load composite bearings.

Ball bearings in the 38 mm (1 1/2") and 51 mm (2") sheaves minimize friction. The 25 mm (1") wire sheave uses low-friction washers for this purpose.

Two 160 sheaves make up the 161 dual-sheave universal lead. Use this sheave to divert a line that must turn in either direction.

Use Cruising ESP sheaves to handle high static loads from halyards and reef lines. Sheaves are carbon-black Delrin for UV-protection and turn on stainless steel spacers. Contained sideload ball bearings allow sheaves to spin freely when loads are released. Sheaves require a sideplate for the sideload balls to roll on.

Use for:

Custom applications



160



277



415

Ball bearings handle low loads and sideloads from unfair leads.

Plastic sleeve bearing for high static loads



161



265



2760



6062



6063



6064



1533
1534



303



307



311

Jeanneau 51 © Jeanneau

Part No.	Description	Sheave Ø		Width		Weight		Center pin Ø		Max Ø		Wire		Maximum working load	
		in	mm	in	mm	oz	g	in	mm	in	mm	in	mm	lb	kg
160	29 mm	1 1/8	29	1/2	12	0.25	7	1/4	6.27	5/16	8			300	136
161	29 mm	1 1/8	29	7/8	22	1	28	1/4	6.27	5/16	8			300	136
265	38 mm	1 1/2	38	9/16	14	.5	14	1/4	6.27	3/8	10			300	136
277	22 mm	7/8	22	13/32	10	0.1	3	3/16	4.75	1/4	6			200	91
303	25 mm	1	25	9/32	7	0.25	7	3/16	4.75	5/32	4	3/32	2	1000	454
307	38 mm	1 1/2	38	13/32	10	1	28	1/4	6.27	3/16	5	1/8	3	1500	680
311	51 mm	2	51	13/32	10	1.5	43	5/16	8.1	1/4	6	3/16	5	2000	907
415	16 mm	5/8	16	5/16	8	0.13	4	3/16	4.75	3/16	5			250	113
1533	51 mm	2	51	7/8	22	1.5	43	1/4	6.27	5/8	16			500	227
1534	51 mm/aluminum	2	51	7/8	22	2.5	71	1/4	6.27	5/8	16	3/16	5	500	227
2760	57 mm	2 1/4	57	5/8	15	.88	25	1/4	6.27	3/8	10			300	136
6062	40 mm	1 9/16	40	11/16	17	0.8	23	5/16	8.1	1/2	12			1250	567
6063	57 mm	2 1/4	57	13/16	21	1.6	46	3/8	10	5/8	16			2500	1134
6064	75 mm	2 15/16	75	7/8	22	4.4	126	3/8	10	3/4	19			3500	1588

Delrin is a registered trademark of E. I. du Pont de Nemours and Company or its affiliates.

Big Boat Sheaves

Big Boat sheaves are available for special applications as well as for replacement sheaves in Big Boat blocks. Made of Hard Lube-anodized, 6061-T6 aluminum, sheaves feature Torton® rollers to carry high radial loads and carbon-black Delrin® ball bearings to support sideloads and provide UV-protection. Select sheaves based on load-carrying capability.

Installation requires clamping or securing inner race.

Use for:

- Mainsheets
- Spinnaker sheets
- Afterguy/foreguy
- Footblocks



Torton roller/ball bearing system

Hard Lube-anodized
6061-T6 aluminum

Carbon-black balls for UV-protection



Xp 55, X-Yachts © X-Yachts



500



603



1539



518
519
520



657



550

Part No.	Sheave Ø		Width		Weight		Center pin Ø		Fasteners		Fastener circle		Max line Ø		Maximum working load		Breaking load	
	in	mm	in	mm	oz	g	in	mm	in	mm	in	mm	in	mm	lb	kg	lb	kg
500	3	76	7/8	22	6	170	3/8	10	3/8	10			9/16	14	4950	2245	9900	4490
518	4 1/2	114	1	25	16	454	3/4	19.1	3/8	10	1 3/8	35	3/4	18	7500	3401	15000	6803
519	5 1/2	140	1 1/8	29	27	765	7/8	22.28	3/8	10	1 5/8	41	7/8	22	9100	4127	18200	8254
520	7	178	1 1/8	29	45	1280	1 1/2	38	1/2	12	2 1/2	64	7/8	22	14000	6349	28000	12698
550	4	102	7/8	22	10	284	3/8	10	3/8	10			9/16	14	4950	2245	9900	4490
603	3	76	1 9/16	40	10	284	3/8	10	3/8	10			3/4	18	4950	2245	9900	4490
657	4 1/2	114	1 5/8	41	25	709	3/4	19.1	3/8	10	1 3/8	35	7/8	18	14850	6736	29700	13472
1539	2 1/2	64	1 3/8	35	7	198	5/16	8.1	5/16	8			1/2	12	3000	1361	6000	2721

Delrin is a registered trademark of E. I. du Pont de Nemours and Company or its affiliates. Torton is a registered trademark of Solvay Advanced Polymers, L.L.C.

V Sheaves

High-load titanium V sheaves feature the same incredibly efficient bearing set of angled titanium rollers as Harken's V blocks. Harken V sheaves are extremely versatile! Perfect for running lines underdeck, in mainsheet and spinnaker sheet or drop line systems. They are also perfect to rig clean backstay systems to steady today's slender masts and adjust mast bend. Snap fit Delrin® side covers require no tools to disassemble for maintenance.

V sheaves are available in 1.5T to 20T sizes, labeled with working loads. Use the wide sheave for two-sheet peels. Use the wide tulip sheaves to handle a single line with line-entry range of deflecting angles.



V sheaves are named for the unique V-shaped angled rollers that handle both axial and thrust loads.



T5, 28' foiling monohull © Harry KH / INEOS TEAM UK

Part No.	Description	Sheave Ø		Width		Weight		Center pin Ø		Max line Ø		Maximum working load		Breaking load	
		in	mm	in	mm	oz	g	in	mm	in	mm	lb	kg	lb	kg
3355	1.5T sheave	1 7/8	47	3/4	19	2.4	68	5/8	15.8	11/32	9	3300	1500	6600	3000
3356	3T sheave	2 3/16	56	3/4	19	2.89	82	7/8	22.8	7/16	11	6600	3000	13200	6000
3357	5T sheave	2 7/16	62	15/16	24	4.66	132	7/8	22.8	1/2	13	11000	5000	22000	10000
3358	3T sheave/wide tulip	2 3/16	56	1 3/16	30	6.14	174	5/8	15.8	7/16	11	6600	3000	13200	6000
3375	6.5T sheave/wide tulip	3 1/4	82	1 13/16	46	18.34	520	1 9/32	32.9	5/8	16	14300	6500	28600	13000
3376	8T sheave/wide tulip	4 3/32	104	2 1/32	51	33.23	942	1 3/4	44.9	11/16	18	17600	8000	35200	16000
3377	8T sheave	4 3/32	104	1 9/32	32	18.52	525	1 3/4	44.9	11/16	18	17600	8000	35200	16000
3378	5T sheave/wide tulip	2 7/16	62	1 3/8	35	8.04	228	7/8	22.8	1/2	13	11000	5000	22000	10000
3379	6.5T sheave	3 1/4	82	1 5/32	29	10.02	284	1 9/32	32.9	5/8	16	14300	6500	28600	13000
3380	12T sheave	4 3/4	120	1 5/16	33	19.58	555	2 17/32	64.9	7/8	22	26400	12000	52800	24000
3381	20T sheave	6 1/8	155	1 19/32	40	37.32	1058	2 15/16	74.9	1 3/16	30	44000	20000	88000	40000
3382	5T sheave/wide	2 7/16	62	1 1/4	32	6.42	182	7/8	22.8	1/2	13	11000	5000	22000	10000
3383	12T sheave/wide tulip	4 3/4	120	2 9/16	65	47.62	1350	2 17/32	64.9	7/8	22	26400	12000	52800	24000
3384	1.5T sheave/wide tulip	1 7/8	47	1 1/16	27	3.35	95	5/8	15.8	11/32	9	3300	1500	6600	3000
3385	16T sheave	5 5/16	135	1 17/32	39	27.30	774	2 15/16	74.9	1 1/16	26	35200	16000	70400	32000

Delrin is a registered trademark of E. I. du Pont de Nemours and Company or its affiliates.

High-Load Sheaves

High-load sheaves are offered as replacement parts or for use in special applications. Their bearing system combines sideload-carrying balls with a PTFE composite bushing to carry radial loads. While not as free-rolling as the standard Harken ball/roller bearing system, this compact bearing system is extremely durable and perfect for carrying high loads in a restricted diameter.

Installation requires clamping or securing inner race.

Custom sheaves available by request. View more options on harken.com.

Use for:

- Masts
- Booms
- Deck organizers
- Through-the-transom running backstays



C7842



Part No.	Sheave Ø		Width		Weight		Center pin Ø		Line	Max Ø		Maximum working load		Breaking load*		
	in	mm	in	mm	oz	g	in	mm		in	mm	lb	kg	lb	kg	
712	4	102	7/8	22	10	284	11/16	17.6	1/2	12	5/16	8	12000	5443	32000	14515
714	5	127	1	25	17	481	7/8	22.28	5/8	16	5/16	8	15000	6804	51000	23133
716	6	152	1	25	23	652	7/8	22.28	5/8	16	3/8	10	18000	8165	51000	23133
727	2 1/4	57	7/8	22	4	113	3/8	10	1/2	12	5/16	8	4950	2245	9900	4491
754	3	76	7/8	22	5	142	1/2	12.7	1/2	12	5/16	8	7000	3175	16500	7484
1734	8	203	1 3/8	35	46	1300	1 1/4	31.7	7/8	22	1/2	12	37000	16783	100000	45360
C4579	6	152	1 1/4	32	32	903	1 31/64	37.74	7/8	22			41000	18600	82000	37200
C7842	3 1/2	90	1 15/16	50	20	578	11/16	18	5/8	16			12811	5811	25622	11622

*Based on use of solid 304 stainless shafts.

Narrow Halyard & Steering Sheaves

Narrow high-load sheaves in mastheads improve sail handling, speed sail changes, and allow the use of smaller, lighter halyard winches. Used in steering systems, these sheaves return “feel” to wheel-steered boats.

Sheaves combine sideload-carrying balls with a PTFE composite bushing for radial loads. These durable sheaves are made of 6061-T6 aluminum and are well-suited for masthead and steering installations.

Installation requires clamping or securing inner race.

Use for:

- Masthead/halyard sheaves
- Steering systems



Part No.	Sheave Ø		Width		Weight		Center pin Ø		Line	Max Ø		Maximum working load		Breaking load*		
	in	mm	in	mm	oz	g	in	mm		in	mm	lb	kg	lb	kg	
691	3	76	5/8	16	4.5	128	1/2	12.7	3/8	10	3/16	5	4000	1814	16500	7484
692	4	102	3/4	19	8	227	1/2	12.7	7/16	12	5/16	8	8250	3742	16500	7484
693	5	127	3/4	19	12	340	3/4	19.1	7/16	12	5/16	8	12000	5443	37100	16828
694	6	152	7/8	22	19	539	3/4	19.1	1/2	12	3/8	10	16000	7258	37100	16828
695	7	178	1	25	27	765	1	25.42	9/16	14	7/16	12	21000	9526	66000	29937

*Based on use of solid 304 stainless shafts.



Deck Organizers

Harken deck organizers lead halyards and control lines aft, allowing crew to sail from the security of the cockpit. The injection-molded composite top plate provides superior impact and UV resistance. Asymmetrical sheaves of glass-filled nylon have flared bases to lift lines up and off the deck, and combine with a proven bearing system to reduce friction. Organizers are available in two-, three-, four-, or five-sheave configurations and are stackable for multiple mounting options.



Asymmetrical sheaves lift lines off deck.



Jenga 99, J/99, 9.94 m (32.6'), J Composites, naval architect: Alan Johnstone © Gillian Pearson



Deck organizers stack for additional configurations.



9000
9005



9002
9007



9001
9006



9003
9008

Part No.	Description	Sheave Ø		Length		Height		Weight		Max line Ø		Maximum working load/sheave‡		Fasteners	
		in	mm	in	mm	in	mm	oz	g	in	mm	lb	kg	in	mm
40 mm															
9000	2-Sheave	1 9/16	40	4 1/16	104	15/16	24	2.47	70	1/2	12	1544	700	1/4 FH	6 FH
9001	3-Sheave	1 9/16	40	5 3/4	147	15/16	24	3.63	103	1/2	12	1544	700	1/4 FH	6 FH
9002	4-Sheave	1 9/16	40	7 15/32	190	15/16	24	4.76	135	1/2	12	1544	700	1/4 FH	6 FH
9003	5-Sheave	1 9/16	40	9 3/16	233	15/16	24	5.93	168	1/2	12	1544	700	1/4 FH	6 FH
50 mm															
9005	2-Sheave	1 15/16	50	5 5/16	135	1 7/32	31	4.80	136	5/8	16	2602	1180	5/16 FH	8 FH
9006	3-Sheave	1 15/16	50	7 1/2	191	1 7/32	31	7.02	199	5/8	16	2602	1180	5/16 FH	8 FH
9007	4-Sheave	1 15/16	50	9 11/16	247	1 7/32	31	9.24	262	5/8	16	2602	1180	5/16 FH	8 FH
9008	5-Sheave	1 15/16	50	11 15/16	303	1 7/32	31	11.46	325	5/8	16	2602	1180	5/16 FH	8 FH

DO NOT use Harken equipment for human suspension unless product is specifically certified and labeled for such.

82 ‡If double stacked, upper block/organizer is two-thirds of listed MWL and breaking load.

Big Boat Deck Organizers

Use Big Boat deck organizers to lead multiple lines aft to halyard stoppers or winches. Organizers are also perfect for many other applications that call for a multiple-sheave, cheek-mounted lead block.

Deck organizers feature aluminum hardcoat-anodized sideplates for strength and corrosion resistance.

Use for:

- Halyards
- Reef lines
- Outhauls
- Pole lifts
- Control lines

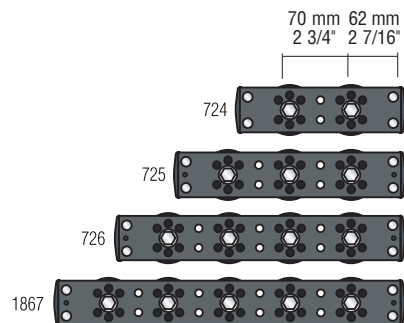

Saare 41ac, 12.42 m (41') © Saare Yachts



Big boat deck organizers are available with up to 10 sheaves by custom order.

Part No.	Description	Sheave Ø		Length		Height		Weight		Line		Max Ø Wire		Maximum working load/ sheave		Breaking load/ sheave		Maximum working load		Breaking load	
		in	mm	in	mm	in	mm	oz	g	in	mm	in	mm	lb	kg	lb	kg	lb	kg	lb	kg
724	2-sheave*	2 1/4	57	7 9/16	192	1 1/8	29	19.5	553	1/2	12	5/16	8	4950	2245	9900	4491	4950	2245	9900	4491
725	3-sheave*	2 1/4	57	10 5/16	262	1 1/8	29	27.5	780	1/2	12	5/16	8	4950	2245	9900	4491	7425	3368	14850	6736
726	4-sheave*	2 1/4	57	13 1/16	332	1 1/8	29	35	992	1/2	12	5/16	8	4950	2245	9900	4491	9900	4491	19800	8981
1867	5-sheave*	2 1/4	57	15 13/16	402	1 1/8	29	44	1247	1/2	12	5/16	8	4950	2245	9900	4491	12375	5613	24750	11227

DO NOT use Harken equipment for human suspension unless product is specifically certified and labeled for such use. *Fasteners included—10 mm (3/8") x 75 mm (3") HH.

Spinnaker Pole Cars

Harken spinnaker pole cars feature recirculating ball bearings to permit adjustment under load. They roll freely on low-beam traveler track to allow crew to adjust for optimal sail shape. Machined aluminum hardcoat-anodized races permit Torlon® bearings to transition smoothly from active to return race for smooth trimming or easing.

Cars feature captive ball bearings, making them easy to load onto the track and to maintain.

Strong, lightweight cars are constructed from one-piece solid aluminum that is Hard Lube-anodized for strength and durability.

Ring fittings are 17-4 PH stainless steel and accept piston pole ends for end-to-end jibing. Midrange and Big Boat cars accept two popular toggle studs and Harken ball-end fittings. Cars are also available from Harken's Custom Division.

Use for:

Spinnaker poles
Whisker poles



Patented wire retaining clips keep balls captive, making cars easy to load and maintain. Composite corner keepers help keep ball bearings captive when the car is off the track. For a cost-effective option, CB+ cars can be modified to run on Harken non-CB track.

Cars fit low-beam track.

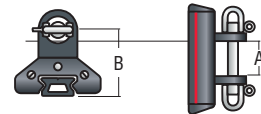

3188
3189



1645
1646
1647



3097
3098
3099

Pogo 50, 15.2 m (50'), Structures, Finot-Conq © Andreas Lindlahr

Torlon is a registered trademark of Solvay Advanced Polymers, L.L.C.
Forespar is a registered trademark of Forespar Products Corporation.

Part No.	Description	Max spin area		Length		Weight		Pin Ø		A				B		Maximum working load		Track	Pole end*
		ft²	m²	in	mm	oz	g	in	mm	in	mm	in	mm	lb	kg				
3188	Small Boat CB/ring	900	85	5	126	12	340									1125	510	2720	Piston
1645	Midrange CB/toggle	1500	140	5 3/16	132	22.4	635	1/2	12.7	1	25	2	51	2300	1043	R27	Forespar® toggle		
1646	Midrange CB/bell	1500	140	5 3/16	132	23.2	658	15/32	12	1 1/2	38			2300	1043	R27	B120/B130 bell end		
1647	Midrange CB/toggle	1500	140	5 3/16	132	24	680	5/8	16	1 3/16	30	2 1/8	54	2300	1043	R27	Sparcraft toggle		
3189	Midrange CB/ring	1350	125	6	151	23.2	658							2100	953	R27	Piston		
3097	Big Boat CB/bell	2000	186	7 1/4	184	46.4	1315	15/32	12	1 1/2	38			4050	1837	R32	B120/B130 bell end		
3098	Big Boat CB/toggle	2000	186	7 1/4	184	47.2	1338	5/8	16	1 3/16	30	2 1/2	63	4050	1837	R32	Sparcraft toggle		
3099	Big Boat CB/toggle	2000	186	7 1/4	184	45.6	1293	1/2	12.7	1	25	2 5/16	59	4050	1837	R32	Forespar® toggle		

See page 276 for replacement balls. *Check dimensions of pole end toggle from suppliers listed.

Soft Attachments

LOUP

LOUP® soft attachments replace heavy stainless steel shackles on racing and cruising boats. Weight savings on large offshore boats can be as much as 91 kg (200 lb).

Strong and lightweight, LOUPS are constructed using multiple coils of tough Dyneema® with Spectra® cover—one of the most durable materials made. An annealing process ensures loads are equal on all coils. Colored tracers on the cover specify LOUP strength by indicating the number of Dyneema coils.

When fitting hardware, choose the LOUP that matches the attachment method shown in the chart. Custom length LOUPS are also available.

T2 Loops

Use T2 Loops in Carbo T2 blocks. These strong, lightweight soft attachments are woven of Dyneema fibers, and are load-set and locked-stitched to prevent stretch after installation.

LOUP is a registered trademark of Yale Cordage.
Dyneema is a registered trademark of DSM Dyneema.
Spectra is a registered trademark of Honeywell International, Inc.



See page 21

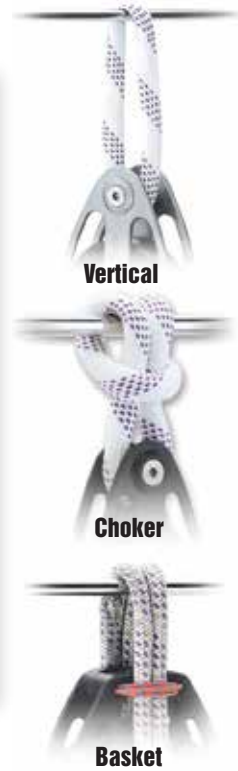
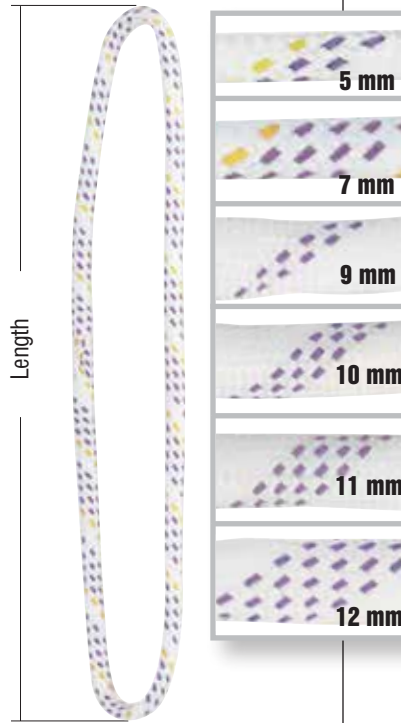

Replacement T2 Loops

Part No.	Ø mm	Length		Weight		Use with
		in	mm	oz	g	
2154	3	5 1/2	140	.03	0.9	2148
2155	3	6 1/2	165	.04	1	2151

Part No.	Ø mm	Length		Weight		Vertical maximum working load		Choker maximum working load		Basket maximum working load		Fits blocks
		in	mm	oz	g	lb	kg	lb	kg	lb	kg	
3202	5	8	203	0.3	9	1275	578	1000	453	2550	1156	3214
3203	7	10	254	0.49	14	2550	1155	2040	920	5100	2310	3230
3139	9	4	100	0.7	20	3600	1630	2880	1305	7200	3265	
3140	9	8	200	1.4	40	3600	1630	2880	1305	7200	3265	
3141	9	11	280	2	55	3600	1630	2880	1305	7200	3265	
3142	10	5	125	1.1	30	5400	2445	4325	1960	10810	4900	
3143	10	9	230	2	55	5400	2445	4325	1960	10810	4900	
3144	10	15	380	3.3	94	5400	2445	4325	1960	10810	4900	3245
3145	11	5	125	1.7	50	7200	3265	5765	2610	14415	6535	
3146	11	9	230	3.1	88	7200	3265	5765	2610	14415	6535	
3147	11	16	400	5.4	154	7200	3265	5765	2610	14415	6535	3255
3148	12	6	150	2.3	65	9010	4085	7200	3265	18020	8170	
3149	12	11	280	4.2	120	9010	4085	7200	3265	18020	8170	
3150	12	17	430	6.5	180	9010	4085	7200	3265	18020	8170	

DO NOT use Harken equipment for human suspension unless product is specifically certified and labeled for such use.

Stainless Steel Shackles

Forged

Stainless steel shackles used on Harken blocks are available separately. Multiple configurations and sizes.

Stamped Shackles

The 072, 138, 246.PAIR, and 2761 shackles are used on most of the Small Boat blocks. They are also useful for a range of other applications.

Snap Shackles

The 111, 112, and 1584 snap shackles fit a variety of blocks and make them removable. Many use a snap shackle on the lower vang block so that it can be moved from the mastbase to the toerail for use as a preventer.

U-Adaptors

The 093 U-Adaptor allows blocks with 10 mm (3/8") posts to be attached to swivel bases or to other blocks with 10 mm (3/8") posts.

The 1598 U-Adaptor allows blocks with up to 15 mm (19/32") posts to be attached to swivel bases or to other blocks with 15 mm (19/32") posts.

The 463 U-Adaptor adapts 75 mm Carbo singles to swivel bases.

The 9050 U-adaptor allows 57/75 mm Carbo blocks to be attached to 170 Hexa-Cat Base or other blocks with 12.7 mm (1/2") posts and 6.35 mm (1/4") pins.

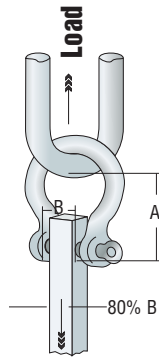

The breaking strengths shown are derived from tests that supported 80% of the length of the screw pin that is unsupported, which is similar to the area of a post in a block. Maximum working loads are no more than half the minimum breaking strength.



Number on shackle denotes screw diameter in millimeters.

High-resistance shackles are marked "HR".

U-Adaptors attach blocks to swivel bases or to other blocks.

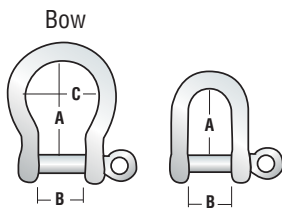

Captive Halyard

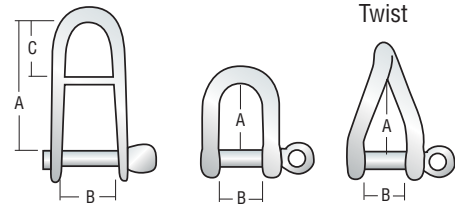

Twist



SNAP SHACKLES



2103, 2110
2117, 2124



2131, 2132



2108, 2115
2122, 2126



2109, 2116
2123, 2127



2107



2104, 2111
2118



2106



2105, 2112
2119, 2125

FORGED SHACKLES



072
138
246.PAIR
2761

STAMPED SHACKLES

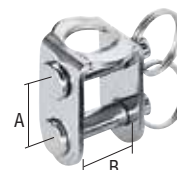

093, 1598,
9050

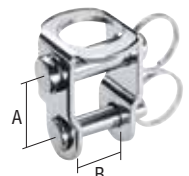

463

U-ADAPTORS

DO NOT use Harken equipment for human suspension unless product is specifically certified and labeled for such use.

Stainless Steel Shackles



Tabasco V, 2-Tonner Class, 12 m (39.4') © Bootswerft Heinrich AG



Part No.	Description	Shackle pin Ø		Weight		A		B		C		Maximum working load		Breaking load	
		in	mm	oz	g	in	mm	in	mm	in	mm	lb	kg	lb	kg
Bow															
2103	5 mm	3/16	5	0.64	18	1	25	3/8	10	11/16	17	1190	540	2380	1080
2110	6 mm	1/4	6	1.04	29.5	1 1/16	27	9/16	14	3/4	19	1650	750	3300	1500
2117	8 mm	5/16	8	2.48	70.5	1 1/2	38	11/16	17	1 1/8	29	3040	1380	6080	2760
2124	10 mm	13/32	10	4.88	138.5	1 7/8	48	7/8	22	1 1/4	32	4870	2210	9740	4420
Shallow Bow															
2131	4 mm	5/32	4	0.3	8.5	5/8	16	5/16	8	7/16	11	810	367	1620	735
2132	5 mm	3/16	5	0.51	14.5	11/16	17	7/16	11	9/16	14	1190	540	2380	1080
Forged "D"															
2108	6 mm	1/4	6	0.88	25	3/4	19	9/16	14			1650	750	3300	1500
2115	8 mm	5/16	8	2.08	59	1	25	11/16	17			3040	1380	6080	2760
2122	10 mm	13/32	10	4.22	120	1 1/4	32	13/16	20			4870	2210	9740	4420
2126	12 mm	1/2	12	6.7	190	1 1/2	38	15/16	24			7120	3230	14240	6460
High-Resistance (HR) "D"															
2109	6 mm	1/4	6	0.8	22.5	3/4	19	9/16	14			2770	1260	5540	2510
2116	8 mm	5/16	8	2	56.5	1	25	5/8	16			5130	2330	10260	4650
2123	10 mm	13/32	10	3.92	111	1 1/4	32	13/16	20			8210	3720	16420	7450
2127	12 mm	1/2	12	6.8	193	1 3/4	44	1	25			12000	5440	24000	10880
Long															
2104	5 mm	3/16	5	0.78	22	1 1/2	38	3/8	10			1190	540	2380	1080
2111	6 mm	1/4	6	1.34	38	1 3/4	44	1/2	13			1650	750	3300	1500
2118	8 mm	5/16	8	3.01	85.5	2 1/4	57	5/8	16			3040	1380	6080	2760
Twist															
2105	5 mm	3/16	5	0.78	22	1 7/16	37	3/8	10			1190	540	2380	1080
2112	6 mm	1/4	6	1.12	32	1 1/8	29	1/2	12			1650	750	3300	1500
2119	8 mm	5/16	8	1.84	52	1 5/8	41	11/16	17			3040	1380	6080	2760
2125	10 mm	13/32	10	4.96	140.5	1 7/8	48	3/4	19			4870	2210	9740	4420
Large Open															
2106	5 mm	3/16	5	0.88	25	1 5/16	33	13/16	20			770	350	2200	1000
Captive Halyard															
2107	5 mm	3/16	5	1.12	32	1 3/8	35	9/16	14	9/16	14	1190	540	2380	1080
Stamped Shackles															
072	Small	3/16	5	0.29	8	1/2	12	7/16	11			1250	567	2500	1134
138	Large	1/4	6	0.54	15.5	11/16	17	5/8	16			1500	680	3000	1361
246.PAIR	Micro (pair)	5/32	4	0.18	5	7/16	11	3/8	9			600	270	1200	545
2761	Medium	1/4	6	0.45	12.7	5/8	15	9/16	14			1500	680	3000	1361
Snap Shackles															
111	Snap shackle	3/16	5	3	85	2 9/16	65					1000	454	2000	907
112	Large snap shackle	1/4	6	4.5	128	3 3/8	86					1500	680	3000	1361
1584	Midrange snap shackle	5/16	8	4	113	3 1/16	78					1800	816	3600	1633
U-Adaptors															
093	U-Adaptor	3/16	5	0.48	13.6	1/2	12	7/16	11			1250	567	2500	1134
463	U-Adaptor	3/16, 1/4	5, 6	0.58	16.3	9/16	14	13/32	10			1250	567	2500	1134
1598	Midrange U-Adaptor	5/16	8	1.57	44.4	1/2	12	7/8	22			1800	816	3600	1633
9050	U-Adaptor	1/4	6	0.92	26	11/16	17	5/8	15			1500	680	3000	1361

DO NOT use Harken equipment for human suspension unless product is specifically certified and labeled for such use.

Eyestraps

Eyestraps are useful accessories. They form light-duty mounting bases for blocks, serve as lash-down points, and can be used for fairleads.

Forged 316 stainless eyestraps are extremely strong and their smooth shape won't chafe line.

Harken offers two sizes of tough, nylon-resin eyestraps to secure shockcord, sheet bags, and other items where loads are light. Available in packages of six.

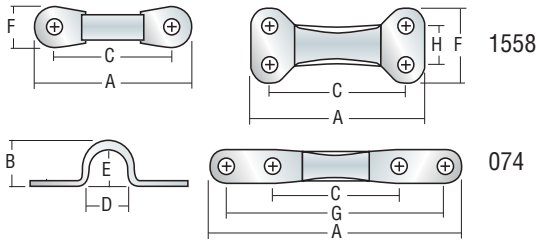

Sailart 17, 4.5 m (14.8')

Part No.	Weight		Fasteners (RH)	A		B		C		D		E		F		G		H		Fits cam	Breaking load	
	oz	g		in	mm	in	mm	in	mm	in	mm	in	mm	in	mm	in	mm	in	mm		lb	kg
073.PAIR*	.16	4.5	#10	5	1 11/16	43	1/2	12	1 1/4	32	7/16	11	3/8	10	7/16	11					1600	726
074	.64	18	1/4	6	3 1/4	83	3/4	19	1 1/2	38	5/8	16	5/8	16	9/16	14	2 3/4	70			4000	1814
137.PAIR*	.32	9	1/4	6	2	51	3/4	19	1 1/2	38	5/8	16	5/8	16	9/16	14				150/365	3000	1361
201.PAIR*	.16	4.5	#10	5	1 7/8	48	3/8	10	1 1/2	38	9/16	14	1/4	6	7/16	11				150/365	1600	726
281.PAIR*	.16	4.5	#8	4	1 7/16	36	1/2	12	1 1/16	27	7/16	11	3/8	10	7/16	11				338/423	1000	454
282.PAIR*	.8	23	1/4	6	2 13/16	71	15/16	23	2 1/16	52	7/8	22	3/4	19	3/4	19				280	3000	1361
419	.5	14	#10	5	2 1/2	64	3/4	19	2	51	3/4	19	5/8	16	1/2	12				418	1600	726
445.PAIR*	.09	2.5	#8	4	1 1/2	38	3/8	10	1 1/16	27	7/16	11	3/8	10	7/16	11					1000	454
1558	1	28	1/4	6	2 1/4	57	5/8	16	1 3/4	45	5/8	16	7/16	11	1 1/8	29			5/8	16	6000	2722
2133	.35	10	#10	5	1 13/16	47	3/4	19	1 1/2	37	3/8	10	9/16	14	3/8	10					2500	1130
2134	.58	16.3	1/4	6	2 1/4	56	13/16	21	1 3/4	43	11/16	17	5/8	15	1/2	12					3500	1588
3287	.28	7.8	1/4	6	1 7/8	46	5/8	16	1 13/64	30	3/8	10	7/16	12	3/4	19					1200	544
3288	.14	4	#10	5	1 11/32	34	1/2	13	29/32	23	3/8	10	3/8	10	1/2	13					1200	544

DO NOT use Harken equipment for human suspension unless product is specifically certified and labeled for such use. *Sold in pairs.

Folding Padeyes

Folding padeyes keep deck and passageways clear. They're ready to attach a snatch block or fender, but fold safely out of the way when not needed.

Bolt-down bases and D-rings are 316 stainless steel. A vulcanized thermoplastic pad prevents rattling and holds the D-ring in position.

Use for:

- Loops/soft attachments
- Jacklines and tethers
- Leads
- Tie downs
- Lifting points
- Fenders

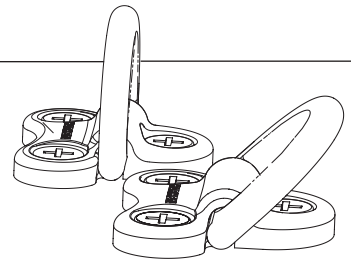
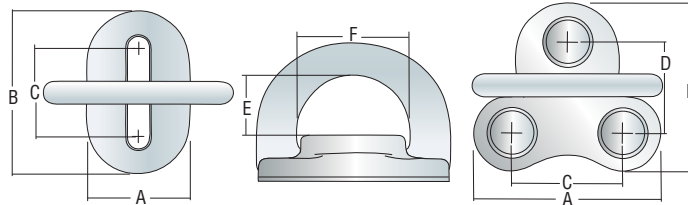

FOLDING PADEYES Q&A

HOW SHOULD I ALIGN THE LOAD ON A FOLDING PADEYE?

Folding padeyes differ from conventional padeyes in that the load should be perpendicular to the hinge and bail instead of in line with it. The strongest positions are with the D-ring vertical or leaning toward the fold-down position, which focuses the load on the side anchored with two screws.

Part No.	Description	A		B		C		D		E		F		Weight		Maximum working load		Breaking load		Fasteners (FH)	
		in	mm	in	mm	in	mm	in	mm	in	mm	in	mm	oz	g	lb	kg	lb	kg	in	mm
3206	6 mm low-load	1	26	1 5/8	41.5	7/8	23			19/32	14.9	1 1/8	28	2.25	65	1760	800	3520	1600	1/4	6
3207	6 mm	1 7/8	47	1 5/8	41.5	1 1/8	28	15/16	23	19/32	14.9	1 1/8	28	2.75	78	3080	1400	6160	2800	1/4	6

Padeyes

Padeyes are great for mounting blocks and are also used as attachment points for staysails, reefing blocks, and hundreds of other items.

Harken offers a range of stainless steel padeyes. The diamond-shaped padeyes, 688 and 689, are 316 stainless and often used at mastbases where the diamond shape allows them to be mounted very close together. The 2759 is 316 cast stainless steel. The 627, 629, and 648 padeyes are 17-4 PH stainless.

For maximum strength always align fixed padeye bails to the load.



Part No.	Maximum working load						Breaking load						Fasteners (FH)	
	1	2	3	1	2	3	1	2	3	1	2	3	in	mm
627	5000	2270	4500	2040	4300	1950	10000	4535	9000	4080	8600	3900	1/4	6
629	20000	9070	12000	5440	14000	6350	40000	18140	24000	10890	28000	12700	1/2	12
648	11800	5358	10375	4705	8500	3855	23600	10716	20750	9430	17000	7710	3/8	10
688	3800	1770	5000	2270	4300	1950	7800	3540	10000	4535	8600	3900	1/4	6
689	8500	3855	8000	3628	7800	3540	19000	8618	17200	7800	15600	7075	5/16	8
2759	2550	1156	2392	1086	2450	1111	5100	2313	4784	2172	4900	2222	1/4	6

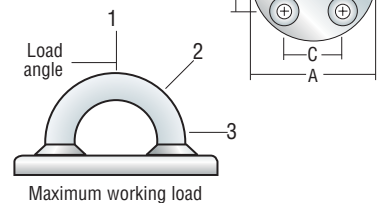

Part No.	Description	A		B		C		D		E		F		G		Weight	
		in	mm	in	mm	in	mm	in	mm	in	mm	in	mm	in	mm	oz	g
627	Small round	2 1/4	57			1 1/16	27	1 3/16	30	1 3/16	30	5/8	16	1 5/16	24	4.16	118
629	Large round	3 3/4	95			1 3/4	44	1 7/8	48	2	51	1 1/16	27	1 3/4	44	23	652
648	High-load medium	3	76			1 5/16	33	1 9/16	40	1 15/16	50	1 1/8	29	1 7/16	37	11	312
688	Small diamond	3 1/8	79	2	51	2 3/8	60	1 1/4	32	1 3/16	30	9/16	14	7/8	22	4.75	135
689	Large diamond	3 7/8	98	2 5/16	59	2 7/8	73	1 3/8	35	1 9/16	40	7/8	22	1 1/16	27	7.5	213
2759	Padeye/fits 22 mm cars with sheaves	2 1/4	56	3/4	18	1 1/2	38			1	26	9/16	15	5/8	16	1.3	38

DO NOT use Harken equipment for human suspension unless product is specifically certified and labeled for such use.

Removable & Fixed Padeyes

Removable Padeyes

Harken offers a variety of removable padeyes for blocks from 57 mm Black Magic, to custom blocks with maximum working loads of 23,000 kg (50,715 lb). Bases swivel so padeyes align to the load. This prevents the reduction of the block's maximum working load. The swivel feature is a Harken exclusive.

Fixed Padeyes

In-deck padeyes are recessed into the deck creating a discreet, low-profile design. Lightweight and compact, Harken padeyes work well with almost any soft-attach block, including Black Magic Loop blocks, Snatch blocks and V blocks.

Padeyes are mirror-polished, stainless steel to complement the look of classic and modern yachts.



HC7852



C6779
C9374
C9761



C10768
C9512
C9511
C9760

C9775
C9240



C9064
C8997

In-deck loop padeyes provide a clutter-free deck.

See page 89

627
648
629



HC7343
HC6107
HC8224

REMOVABLE PADEYES

Removable Tops

Part No.	Description	Above deck Ø		Weight		Maximum working load		Use with
		in	mm	oz	g	lb	kg	
HC8207	Bail top	2 1/4	57	7.4	209	4410	2000	HC7340
HC7327	Swivel top	2 1/4	57	9.6	272	5005	2270	HC7340, 627
HC7388	Swivel top	3 1/4	83	22.4	635	11814	5358	C10768, HC7389, 648
HC7224	Swivel top	4 1/4	108	28.5	807	20000	9070	HC7403, C9512, 629
C6779	Stand-up toggle top*	4 1/4	108	54.8	1553	20000	9070	HC7403, C9512
C9374	Stand-up toggle top*	3 15/16	100	86	2439	33075	15000	C9511, C9775
C9761	Stand-up toggle top*	6 1/2	165	176.3	4999	50715	23000	C9760, C9240

Assemblies (Top & Bottom)

Part No.	Component	
	Deck cup	Top
HC7852	HC7340	HC8207
HC7343	HC7340	HC7327
HC6107	HC7389	HC7388
HC8224	HC7403	HC7224
C9527*	C9511*	C9374*
C9758*	C9760*	C9761*

Removable Padeye Deck Cups

Part No.	Description	Above deck Ø		Weight		Fasteners	Maximum working load		Use with
		in	mm	oz	g		lb	kg	
HC7340	Bolt-down deck cup	2 1/4	57	4.5	127	4 x M6	5005	2270	HC8207, HC7327
C10768	Stud deck cup*	3 1/4	83	45	1275	1 x M39	11025	5000	HC7388
HC7389	Bolt-down deck cup	3 1/4	83	12.8	362	4 x M10	11814	5358	HC7388
HC7403	Bolt-down deck cup	4 1/4	108	41.6	1179	4 x M12	20000	9070	HC7224, C6779, C9584
C9512	Stud deck cup*	3 3/4	95	53.8	1524	1 x M48	26460	12000	HC7224, C6779
C11177	Soft attachment*	3 1/2	90	127.4	3610	1 x M60	22046	10000	C11173, C11334
C9511	Stud deck cup*	3 15/16	100	71.1	2016	1 x M56	33075	15000	C9374, C11003
C9775	Bolt-down deck cup*	5 1/2	139	63.2	1792	6 x M16	33075	15000	C9374, C11003
C9760	Stud deck cup*	4 1/2	114	148	4196	1 x M76	50715	23000	C9761
C9240	Bolt-down deck cup*	6 1/2	165	88.8	2517	6 x M20	50715	23000	C9761

FIXED PADEYES



C9064
C8997



C9153
C9057
C10063

Fixed Padeyes

Part No.	Description	Above deck Ø		Weight		Maximum working load	
		in	mm	oz	g	lb	kg
C9064	5T soft attachment*	3 11/32	85	41.6	1179	11025	5000
C8997	12T soft attachment*	4 3/16	106	88.2	2500	26460	12000
C9153	5T U-Bolt*			17.8	505	11025	5000
C9057	9T U-Bolt*			37.4	1021	19845	9000
C10063	12T U-Bolt*			106	2215	26460	12000

DO NOT use Harken equipment for human suspension unless product is specifically certified and labeled for such use.

*Contact Harken to request quote and lead time.

Lead Rings

Harken lead rings are simple, weight-saving devices used to route line for jib in-haulers, twings, barberhaulers, Lazy Jacks, cascading backstays and other applications requiring minimal fine-tune adjustments. Rings are Hard Lube-anodized 6061-T6 aluminum for a smooth, slippery surface. With no moving parts, wear is minimal.

Part No.	Description	Center hole Ø		Outer groove width		Weight	
		in	mm	in	mm	oz	g
3269	Lead ring	5/16	8	3/16	5	0.093	2.65
3270	Lead ring	7/16	10	1/4	6	0.155	4.4
3271	Lead ring	9/16	14	7/16	10	0.414	11.75
3272	Lead ring	7/8	20	9/16	14	1.34	37.85
3273	Lead ring	1 1/8	28	7/8	20	3.7	105
3282	Floating jib lead ring	23/32	18	5/16	8	1.36	38.5
3283.PAIR	Lead ring (pair)	3/16	5	1/8	3	0.029*	0.82*
3284.PAIR	Lead ring (pair)	1/4	6	5/32	4	0.053*	1.5*

*Weight each.



LEAD RINGS Q&A

I'M THINKING OF USING HARKEN LEAD RINGS TO ADJUST MY VANG. WHAT ARE YOUR THOUGHTS?

Harken Lead Rings should only be used for applications with high static loads, where trimming angles aren't acute, or where only minor adjustments are needed. They will definitely save you weight in your vang system, but you'll be adding friction to the line compared to free-running ball bearing blocks.



Sugar 3, Italia 11.98, 11.98 m (39'), Italia Yachts, naval architect: Matteo Polli © Fabio Taccola

Jib Leads & Fairleads

Bolt-Down Fairleads

Harken Bolt-Down Fairleads are used as shallow-angle line deflectors on boats 6 - 15 m (20 - 50'). These weight-saving fairleads are built of 6061-T6 Hard Lube-anodized aluminum for durability. Smooth surfaces and radiused center holes minimize line wear.

Bolt-Down Fairleads are available in single, double, and triple configurations with 12 or 16 mm hole sizes.

Grand Prix Jib Leads

Strong aluminum jib leads deflect jib sheets to winches, preventing overrides. These jib leads have two small drilled holes through which a loop can be spliced to attach the hobbles. This temporarily secures the jib/genoa clew to free-up a winch for mark roundings.

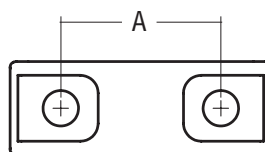

Fastener spacing



TECH TIP

Hex-head bolts are ideal for one-person through-deck fastening as the hexagonal head is held securely by the sides of the inset when being tightened.



Maxi 650, IDBmarine, 6.5 m (21.3'), naval architect: David Raison © Jacques Le Gall

Part No.	Description	Length		Width		Height		Max line Ø		Weight		Fasteners*		A	Maximum working load		Breaking load	
		in	mm	in	mm	in	mm	in	mm	oz	g	in	mm		lb	kg	lb	kg
Bolt-Down Fairlead																		
3274	Single/12 mm hole	1 7/8	48	11/16	18	1 1/8	28.2	3/8	10	.99	28	1/4	6	32	2000	908	4000	1816
3275	Double/12 mm hole	2 7/8	74	11/16	18	1 1/8	28.2	3/8	10	1.73	49	1/4	6	57.4	2000	908	4000	1816
3276	Triple/12 mm hole	3 7/8	99	11/16	18	1 1/8	28.2	3/8	10	2.43	69	1/4	6	82.8	2000	908	4000	1816
3277	Single/16 mm hole	2 3/8	60	7/8	22	1 1/4	31.8	9/16	14	1.66	47	5/16	8	37	4000	1816	8000	3632
3278	Double/16 mm hole	3 9/16	91	7/8	22	1 1/4	31.8	9/16	14	2.82	80	5/16	8	67.5	4000	1816	8000	3632
3279	Triple/16 mm hole	4 3/4	121	7/8	22	1 1/4	31.8	9/16	14	3.95	112	5/16	8	98	4000	1816	8000	3632
Jib lead																		
3280	Midrange	2 15/16	75	7/8	22	1 7/16	37	1/2	12	2.97	84	1/4	6	55	1500	680	3000	1360
3281	Big Boat	4 15/16	125	1 1/8	29	2 5/16	58	7/8	22	9.72	276	7/16**	10***	96	4250	1930	8500	3860

*HH, SH, CH in 6 mm, 5/16" and 8 mm. Size 1/4" in SH only. **7/16" in HH and SH. ***10 mm in HH, SH and CH.

Aluminum Tiller Extension

The rigid anodized body of this tiller extension transmits subtle boat and rudder movements, allowing the skipper to steer by the feel of the helm. The simple and lightweight design has no unnecessary frills—every aspect contributes to its strength, stiffness, or comfort. The universal joint and nonslip foam grip are UV-protected and perfect for full dagger-grip and fingertip steering.



Part No.	Description	Length		Tube Ø		Weight		Fastener spacing		Fasteners		Joint type	Tube material
		in	mm	in	mm	oz	g	in	mm	in	mm		
7100.24	Tiller extension	24	600	5/8	16	4.1	117	1 1/4	31.8	3/16	5	Universal	Aluminum
7100.30	Tiller extension	30	760	5/8	16	4.9	138	1 1/4	31.8	3/16	5	Universal	Aluminum
7100.33	Tiller extension	33	840	5/8	16	5.2	149	1 1/4	31.8	3/16	5	Universal	Aluminum
7100.36	Tiller extension	36	915	5/8	16	5.6	160	1 1/4	31.8	3/16	5	Universal	Aluminum
7100.42	Tiller extension	42	1070	5/8	16	6.3	178	1 1/4	31.8	3/16	5	Universal	Aluminum
7100.48	Tiller extension	48	1220	5/8	16	7.1	203	1 1/4	31.8	3/16	5	Universal	Aluminum
7101	Tiller extension base*	1 3/4	44			0.18	5	1 1/4	31.8	3/16	5		
7102	Replacement universal joint			5/8	16	0.46	13					Universal	

*Fasteners not included

Halyard Tensioners

Designed for rope or wire halyards on large cruisers, the Harken halyard tensioner locks halyards at full hoist and frees your halyard winch for other functions.

The one-piece aluminum car body is Hard Lube-anodized for durability. Track is extruded from 6061-T6 aluminum and hardcoat-anodized for a hard, long-lasting surface.

Choose the 40 mm version in single-pin, double-pin, or triple-pin configurations based on required working load. 32 mm version available in single-pin only. Custom cars can be designed to handle higher loads.



HC9733
HC9503
HC9953
HC9639
HC9504

To lock pin in up position, pull the handle up with a lanyard or by hand and twist 90 degrees.

Part No.	Description	Length		Width		Weight		Maximum working load	
		in	mm	in	mm	oz	g	lb	kg
32 mm T-Track									
HC9639	Single-pin car	6	152	2 1/4	57	18.67	529	6615	3000
HC9733	Self-locking 32 mm track	29 1/2	750	1 1/4	32				
40 mm T-Track									
HC9504	Single-pin car	6 5/16	160	2 9/16	65.1	20.34	577	8818	4000
HC9503	Self-locking 40 mm track for single/double pin	29 1/2	750	1 9/16	40	31.39	890		
HC9953	Self-locking 40 mm track for single/double pin	59 1/16	1500	1 9/16	40	60.56	1717		

TRAVELERS & GENOA LEADS





Francesco Canzi Tech Service Supervisor

Harkenite Since 2008

One thing
Francesco
Canzi likes about

his job as technical service supervisor at Harken Italy is that it's not routine.

On a typical day you can find Francesco helping customers with technical service, installing equipment on racing boats, traveling to regattas around Europe to perform maintenance on participants' boats, commissioning maxi yachts, and performing sea trials. Francesco says one of the most challenging service jobs was to fix some overload issues on winches during sea trials for the J Class *Svea* in 2017.

Francesco, who has a degree in mechanical engineering, has been with Harken Italy since September 2008. Like a lot of Harken employees, he likes to sail during off-hours and takes his Laser out on Como Lake. He can see the mountains from the windows of his home in Saronno, Italy, and he enjoys skiing and mountaineering there.



Dinghy Pinstop Jib Lead Cars

These easy-to-adjust cars combine a spring-loaded pinstop with precise track spacing. Use on dinghies and small sport boats with jibs up to 13 m² (140 ft²). Cars are built of tough 6061-T6 aluminum that is Hard Lube-anodized for durability. Track is hardcoat-anodized.

The 450 pinstop jib lead has a removable bail to attach a spring and block. The 452 bullseye lead has a controlled pivot angle so the cleat is always within easy reach.



Flexible, lightweight, lashing attachment allows block to articulate freely on 450 jib car.

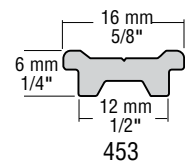

ROSA 2, Rosso 28 8m50 Chantier des ileaux/Paolo Bua Truc Design © Emmanuel Van DETH

Cars

Part No.	Description	Length		Width		Height		Weight		Maximum working load		Breaking load		Track
		in	mm	in	mm	in	mm	oz	g	lb	kg	lb	kg	
450	Bail/pinstop	2 5/8	67	15/16	23	1 1/16	27	2	55	350	159	700	318	453
452P	Bullseye/swivel/365 Carbo-Cam (port)	3 1/8	79	3 7/16	87	2 7/16	62	7	194	250	113	500	227	453
452S	Bullseye/swivel/365 Carbo-Cam (stbd)	3 1/8	79	3 7/16	87	2 7/16	62	7	194	250	113	500	227	453

Track

Part No.	Description	Length		Mounting hole spacing		Weight		Fasteners (FH)	
		in	m	in	mm	oz	g	in	mm
453.9.5	Low-beam/pinstop holes*	9 1/2	0.24	3	76	1.22	35	#10	5
453.12	Low-beam/pinstop holes*	11 11/16	0.3	3	76	1.5	43	#10	5
453.15	Low-beam/pinstop holes*	14 11/16	0.37	3	76	1.8	52	#10	5
453.18	Low-beam/pinstop holes*	17 11/16	0.45	3	76	2.3	65	#10	5
453.24	Low-beam/pinstop holes*	23 11/16	0.6	3	76	3.1	87	#10	5

*1st hole 34 mm (1 3/8").

Crossbow Pivoting Self-Tacking Jib Traveler System

The Crossbow self-tacking jib traveler is designed for high-performance dinghies, skiffs, and catamarans under six meters (20'). The system features a curved track that hinges to align both car and track with the sheet loads for less friction, more load-bearing capacity, and for an ultra-lightweight design.

The two-piece car body is machined of 6061-T6 aluminum and Hard Lube-anodized for strength and corrosion resistance. Curved races evenly distribute the loads on Turlon® ball bearings for low-friction rolling. A Delrin® cap keeps the balls captive when the car is removed from the track. The hardcoat-anodized track has three pivoting attachment points that distribute the load.

Track is offered in 20 or 50 mm heights. Use 20 mm track for the lightest weight setup, or for spinnakers with a separate tack and halyard system.

Use 50 mm track with a single-line spinnaker system. The track's center strut has a hole for a fair, chafe-free halyard lead.

Turlon is a registered trademark of Solvay Advanced Polymers L.L.C.

Delrin is a registered trademark of E. I. du Pont de Nemours and Company or its affiliates.



Curved races evenly distribute the loads on Turlon ball bearings for low-friction rolling.



The track's center strut has a hole for a fair, chafe-free halyard lead.



2758.950MM.20
2758.1.1M.20

2758.1.1M.50



Goodall Design Viper, Goodall Design, Greg Goodall Naval Architect © Stephen Harman

Track

Part No.	Length		Hole spacing			Weight		Fasteners (FH)	
	ft/in	m	in	mm	oz	kg	in	mm	
2758.950MM.20	3' 1 3/8"	0.95	21 13/16	554	24	0.68	#10	5	
2758.1.1M.20	3' 7 5/16"	1.1	21 13/16	554	27.23	0.77	#10	5	
2758.1.1M.50	3' 7 5/16"	1.1	21 13/16	554	28.3	0.8	#10	5	

Ordering Traveler Systems

1. Determine System Size

Determine size of traveler system (13, 22, 27, 32, 42, or 64 mm) based on mainsail area, placement on the boom, and mono- or multihull. See **Mainsail Traveler System Size Selection** chart. Typical boat lengths are listed as a guideline only.

Typical Boat Lengths:

22 mm Small Boat: 6.7 - 8.5 m (20' - 28')
 27 mm Midrange: 7.9 - 10.7 m (26' - 35')
 32 mm Big Boat: 10.4 - 12.8 m (34' - 46')

Mainsail Traveler System Size Selection

Cars	Maximum mainsail area							
	Monohulls				Multihulls			
	End-boom sheeting ft ²	Mid-boom sheeting m ²	End-boom sheeting ft ²	Mid-boom sheeting m ²	End-boom sheeting ft ²	Mid-boom sheeting m ²	End-boom sheeting ft ²	Mid-boom sheeting m ²
Dinghies/Light Daysailers								
13 mm Micro CB	110	10.2	85	8	85	8	70	6.5
22 mm Small Boat CB: low-load	125	11.6	100	9.3	100	9.3	80	7.5
22 mm Small Boat CB: standard	160	14.9	135	12.5	135	12.5	110	10.2
22 mm Small Boat CB: high-load:1250 series	200	18.6	160	14.9	160	14.9	135	12.5
27 mm Midrange CB: standard	350	32.5	285	26.5	275	25.5	215	20
Small Offshore Boats/Heavy Daysailers								
22 mm Small Boat CB: standard	150	14	125	11.5	135	12.5	110	10.2
22 mm Small Boat CB: high-load:1250 series	190	17.5	150	14	160	14.9	125	11.5
27 mm Midrange CB: standard	260	24	215	20	215	20	160	14.9
27 mm Midrange CB: high-load	300	28	240	22	240	22	190	17.5
Large Offshore Boats								
32 mm Big Boat CB: standard	425	39.5	350	32.5	350	32.5	300	28
32 mm Big Boat CB: high-load	550	51	450	42	450	42	350	32.5
32 mm Big Boat CB: 2 stand-up toggles/32 mm CRX Roller: 3074	575	53.4	500	46.5	500	46.5	425	39.5
32 mm Big Boat CB: 2 T3201Bs joined by 580	700	65	525	49	525	49	450	42
32 mm Big Boat CB: 2 high-load cars coupled	1100	102	900	83.6	900	83.6	750	69.7
42 mm Mini-Maxi: 3068/32 mm CRX Roller: 3075	1100	102	900	83.6	900	83.6	750	69.7
64 mm Maxi: 3070	1400	130	1100	102	1100	102	900	83.6

2. Select Track

Select size and length of track (sizes listed by width measurement of top of track in millimeters). Choose low-beam track if it will be supported the entire length. Choose high-beam track for spanning companionways, cockpits, etc.

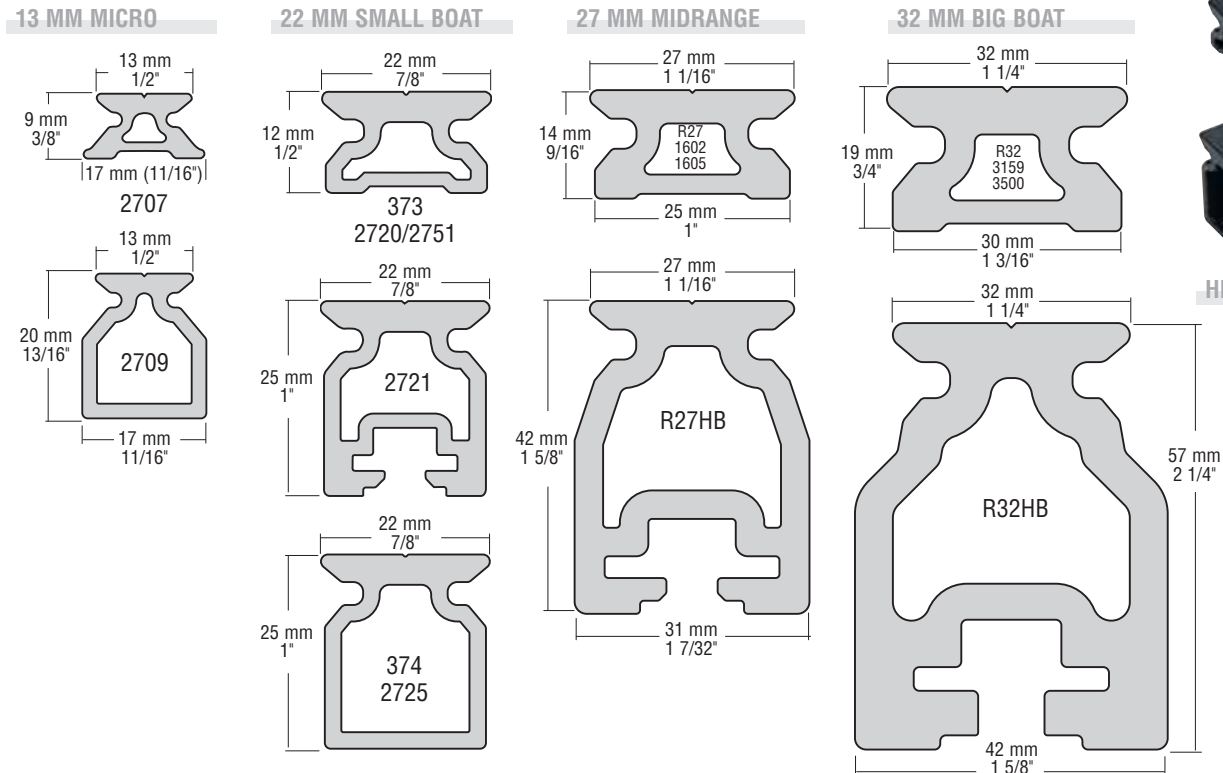

Ordering Traveler Systems

3. Select Car & Purchase Requirements

Based on system size and purchase requirements, select a car and accessories that match track and load requirements. Select control blocks for the car.

A kit contains car-mounted components to make a 2:1, 3:1, or 4:1 system. 27 and 32 mm systems only.

Cars come standard with shackles for attaching the mainsheet to the car. Upgrade to a stand-up toggle with control tangs to attach high-performance ball bearing control blocks. See **Purchase Selection Guides** for examples and sizing.

4. Choose End Controls

Choose end controls that mate with the control blocks on the traveler car for the correct purchase system, including a deadend, allowing clean-running lines. Use Carbo ball bearing end controls with toggle-mounted, ball bearing control blocks, or use ESP sleeve bearing end controls with ESP car-mounted, sleeve-bearing control blocks.

Options include end controls with attached cams, or purchase cams separately and mount remotely. See pages 260 - 261 for common systems.

5. Choose Endstops

Endstops are designed to absorb shock loads and should be installed when end controls are not used. Trim caps finish off track ends cleanly. Select high- or low-beam endstops/trim caps to match track. Low-beam, line-shedding endstops prevent snags. Sold in pairs.

6. More Information

Previous steps show the most common configurations. Other options include windward sheeting cars, soft attachments, coupled cars, track risers, and track splice links.

If you have questions, contact a professional rigger or Harken Technical Service at technicalservice@harken.com.



CARBO BALL BEARING END CONTROLS

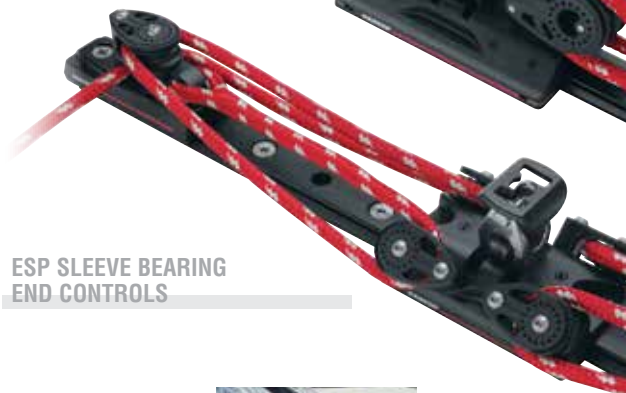

ESP SLEEVE BEARING END CONTROLS



WINDWARD SHEETING



SOFT-ATTACH



COUPLED CARS



TRACK RISERS

Ordering Genoa Lead Systems

The chart below sizes lead cars for the #1, #2, and #3 genoas based on typical loads for these sails. See **Block Loading vs Angle of Deflection** and **Genoa System Loading** on page 279 to size for different deflection angles and wind speeds. Visit www.harken.com or see page 259 for common configurations.

Adjustable genoa lead cars	Maximum sail area								Mini- Maxi		
	22 mm Small Boat		27 mm Midrange		32 mm Big Boat						
	ft ²	m ²	ft ²	m ²	Standard ft ²	High-load m ²	ft ²	m ²			
#1 & #2 genoa	450	41	750	70	1500	139	2700	251	4400	409	Assumes 155% genoa/25 knots apparent wind/45° sheet lead angle
#3 genoa	175	16	330	31	435	40	650	60	1300	121	Assumes 100% genoa/40 knots apparent wind/60° sheet lead angle



Glomérule, TRICAT-30, 9.14 m (30'), naval architect:
Jack Michal / Antoine Houdet © Tricat / Antoine Houdet

CB TRAVELERS & GENOA LEAD CARS



Harken ball bearing traveler and genoa lead cars with multipart purchases allow easy adjustment of loaded sails from the cockpit. Whether racing or cruising, these smooth-rolling systems pay huge dividends in sail control and are safer and faster than playing the sheet. Patented CB (captive bearing) systems are available in four sizes to fit boats from the smallest dinghies to big boats. Non-CB systems (CRX, Mini-Maxi, and Maxi) are offered for larger yachts.

Strong, corrosion-resistant cars and track stand up to sun, salt, and time

- One-piece, 6061-T6 aluminum cars
Hard Lube-anodized, UV-stabilized.
- Cars CNC sculpted to remove excess weight.
- Track is 6061-T6 aluminum, hardcoat-anodized.

Low-friction ball bearing cars for easy adjustment under load

- Torton® bearings roll smoothly under both high and low loads.



Travelers: Asked & Answered



Easy loading and maintenance

- CB wire retaining clips and composite corner keepers keep ball bearings captive when car is off the track.



Choice of end-boom or mid-boom configurations

- Use with high-beam track when raising traveler out of cockpit.



Cost-effective retrofit options

- CB+ cars can be modified to run on old style Harken non-CB track supplied until 2003; upgrade cars without replacing track. Look for the plus sign on the end of the car to confirm that it is a CB+ car.

Replacement kits restore traveler performance

- Harken replacement traveler kits are the fastest, easiest way to replace an old traveler with one that fits and works correctly. Take the guesswork out of picking the right parts.
- Five boxed kits come in three sizes: two Small Boat, two Midrange, and one Big Boat.
- Kits meet installation requirements of boats from 5.5 – 13.4 m (18 – 44').
- Kits include car and end controls; purchase track and fasteners separately.



Ball or roller bearing control block options

- Stand-up toggles with ears attach Carbo or Black Magic control blocks for 2:1 up to 6:1 systems.
- Pair with Carbo ball bearing end controls for reduced friction and smooth-running system.
- Carbo-Cam or Cam-Matic cleats keep weight minimal.



Sleeve bearing control block options

- Cars feature built-in sleeve bearing control blocks for value-oriented options for installation of 2:1 to 4:1 systems.
- Pair with sleeve bearing end controls for durability and strength.
- Carbo-Cam or Cam-Matic cleats keep weight minimal.

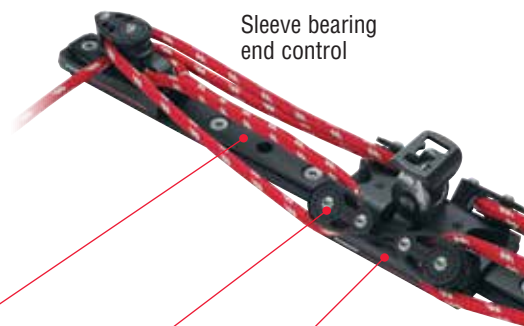

Materials
For properties see pages 16-17.



6061-T6 aluminum:
Hardcoat-anodized track



Carbo composite:
Control blocks



6061-T6 aluminum:
Hard Lube-anodized car bodies

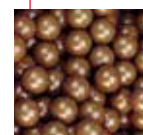

Torlon:
Ball bearings

13 mm Micro: CB Track & Accessories

Track

Track comes in low- and high-beam configurations, and is predrilled with holes for mounting fasteners.

Endstops

Endstops absorb shock loads. Use the built-in groove to deadend 2:1 control line. Sold in pairs. Fasteners not included.

Splice Links

Splice links join track and keep it aligned during installation.

Curved Track

Harken will bend track to your specifications. See page 127.



2706 2710
LINE-SHEDDING ENDSTOPS



2711
SPLICE LINKS

LOW-BEAM



HIGH-BEAM DRILLED

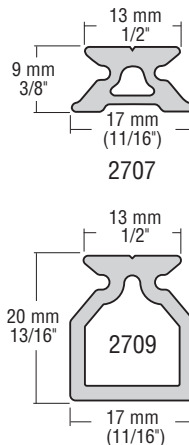
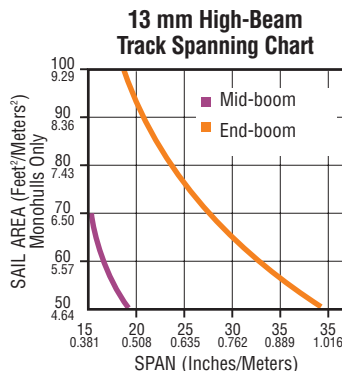

Track bending

Track	Minimum radius Horizontal bend*	
	in	m
2707	60	1.52
2709	60	1.52

*Horizontal only. Contact Harken Tech Service for vertical bends.

Track	Fastener hole distance from track end	
	in	mm
2707	1	25
2709	1 15/16	50

470 © US Sailing Team / Will Ricketson

Part No.	Description	Length		Mounting hole spacing		Weight		Fasteners (FH)		Line-shedding endstop‡	Splice link
		ft/in	m	in	mm	oz	g	in	mm		
Metric Track											
2707.600MM	Low-beam	2'	0.6	1 31/32	50	4.6	129	#8	4	2706	2711
2707.1M	Low-beam	3' 3"	1	1 31/32	50	7.6	214	#8	4	2706	2711
2707.1.2M	Low-beam	3' 11"	1.2	1 31/32	50	9	257	#8	4	2706	2711
2707.2M	Low-beam	6' 7"	2	1 31/32	50	15.1	429	#8	4	2706	2711
2707.2.5M	Low-beam	8' 2"	2.5	1 31/32	50	18.9	536	#8	4	2706	2711
2709.1M	High-beam	3' 3"	1	3 15/16	100	13.2	375	#8	4	2710	
2709.1.2M	High-beam	3' 11"	1.2	3 15/16	100	15.8	449	#8	4	2710	
2709.2M	High-beam	6' 7"	2	3 15/16	100	26.4	749	#8	4	2710	

‡Sold in pairs.

13 mm Micro: CB Cars

Harken Micro CB traveler cars are used on small dinghies and catamarans.

About CB traveler cars: see feature pages at beginning of this section.



2701



E-Scow, 2015 Blue Chip Regatta



Block not included

Loop cars matched with 29 or 40 mm Carbo T2 blocks attached with high-tech line provide the ultimate lightweight, low-profile system.



Pivoting shackle cars have low pivot points to handle nonvertical loads.



2702



2700



2703



2705



2704

16 mm control blocks spin on stainless steel balls that roll freely under high loads. The step-down design keeps the controls low and clear of the mainsheet block.

CARS

CAR CONTROLS

Cars

Part No.	Description	Length		Width		Car body height		Weight		Maximum working load		Breaking load	
		in	mm	in	mm	in	mm	oz	g	lb	kg	lb	kg
2700	Pivoting shackle	2 3/16	56	1 9/16	40	3/4	19	1.76	50	310	140	1500	680
2701	Pivoting shackle/control blocks	3 7/16	87	1 9/16	40	3/4	19	2.56	73	310	140	1500	680
2702	Pivoting shackle/tangs	2 3/8	61	1 9/16	40	3/4	19	2.08	59	310	140	1500	680
2703	Loop	2 3/16	56	1 9/16	40	3/4	19	1.6	45	310	140	1500	680

See page 275 for replacement balls.

Car Controls

Part No.	Description	Sheave Ø		Length		Weight		Max line Ø		Maximum working load		Breaking load		Purchase
		in	mm	in	mm	oz	g	in	mm	lb	kg	lb	kg	
2704	Control block (pair)	5/8	16	1 5/16	33	0.39	11	7/32	5	250	113	750	339	2:1
2705	Control tang (pair)			13/16	21	0.11	3			250	113	750	339	1:1

22 mm Small Boat: CB Track & Accessories

Variable Hole Spacing Track

CB (Captive Ball) high-beam variable hole spacing track is used to span cockpits or other unsupported areas. Track features internal slide bolts, allowing new track to be installed without drilling additional holes.

High-Beam Drilled Track

374 and 2725 high-beam track is predrilled with holes for mounting fasteners.

Low-Beam Track

Low-beam track is available with or without pinstop holes.

Endstops/Trim Caps

When end controls are not used, add endstops to absorb shock loads. When end control assemblies are used, trim caps finish track ends. Sold in pairs. Fasteners not included.

Splice Links

Splice links join track and keep it aligned during installation.

Curved Track

Harken will bend track to your specifications. See page 127.

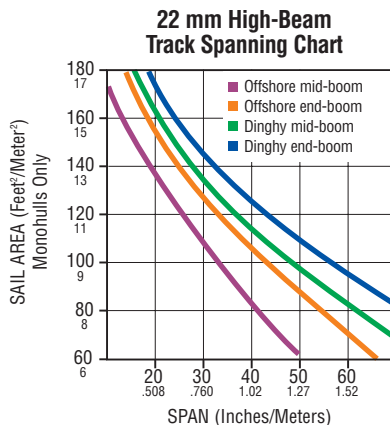

Track	Fastener hole distance from track end	
	in	mm
Metric	1 15/16	50
Retrofit	2	51

Track Bending

Cars	Minimum radius			
	Horizontal bend		Vertical bend	
	in	m	in	m
2726 - 2734, 2744 - 2745	42	1.07	65	1.65
2735 - 2738, 2746, 2735.NW	80	2.03	94	2.38
2726.NW, 2727.NW, 2754.NW	42	1.07	42	1.07

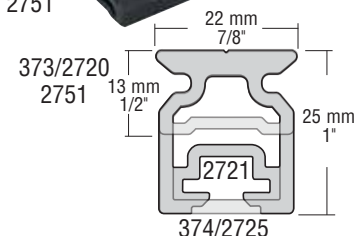
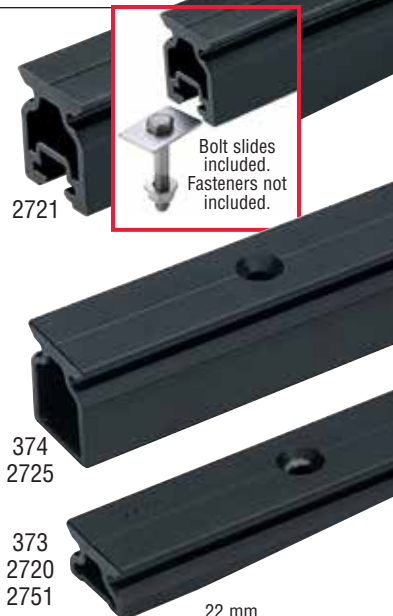

Part No.	Description	Length		Mounting hole spacing*		Weight oz/g	Fasteners in/mm	High-load endstop**‡	Low-load/line-shedding endstop‡	Splice link/trim cap‡
		ft/in	m	in	mm					
Metric Track										
2720.600MM	Low-beam	1' 11 5/8"	0.6	3 15/16	100	9.1 258	10FH 5FH	263/E2200	173/446‡‡	2724/2722
2720.1M	Low-beam	3' 3 3/8"	1	3 15/16	100	15.2 430	10FH 5FH	263/E2200	173/446‡‡	2724/2722
2720.1.2M	Low-beam	3' 11 1/4"	1.2	3 15/16	100	18.2 516	10FH 5FH	263/E2200	173/446‡‡	2724/2722
2720.1.5M	Low-beam	4' 11 1/16"	1.5	3 15/16	100	22.8 645	10FH 5FH	263/E2200	173/446‡‡	2724/2722
2720.1.8M	Low-beam	5' 10 13/16"	1.8	3 15/16	100	27.3 775	10FH 5FH	263/E2200	173/446‡‡	2724/2722
2720.2.1M	Low-beam	6' 10 11/16"	2.1	3 15/16	100	31.9 904	10FH 5FH	263/E2200	173/446‡‡	2724/2722
2720.2.5M	Low-beam	8' 2 7/16"	2.5	3 15/16	100	38 1077	10FH 5FH	263/E2200	173/446‡‡	2724/2722
2720.3M	Low-beam	9' 10 1/16"	3	3 15/16	100	45.5 1291	10FH 5FH	263/E2200	173/446‡‡	2724/2722
2720.3.6M	Low-beam	11' 9 3/4"	3.6	3 15/16	100	54.6 1549	10FH 5FH	263/E2200	173/446‡‡	2724/2722
2720.6M	Low-beam***	19' 8 1/4"	6	3 15/16	100	91.1 2582	10FH 5FH	263/E2200	173/446‡‡	2724/2722
2725.1M	High-beam	3' 3 3/8"	1	3 15/16	100	21 586	10FH 5FH	264	174/	/2723
2725.1.2M	High-beam	3' 11 1/4"	1.2	3 15/16	100	24.5 695	10FH 5FH	264	174/	/2723
2725.1.5M	High-beam	4' 11 1/16"	1.5	3 15/16	100	31 879	10FH 5FH	264	174/	/2723
2725.1.8M	High-beam	5' 10 13/16"	1.8	3 15/16	100	37 1055	10FH 5FH	264	174/	/2723
2725.3.6M	High-beam***	11' 9 3/4"	3.6	3 15/16	100	74 2110	10FH 5FH	264	174/	/2723
Variable Hole Spacing Track										
2721.1.2M	High-beam	3' 11 1/4"	1.2	Slide bolt		30 851	5HH	264	174/	/2723
2721.1.5M	High-beam	4' 11 1/16"	1.5	Slide bolt		37.5 1064	5HH	264	174/	/2723
2721.1.8M	High-beam	5' 10 13/16"	1.8	Slide bolt		45 1277	5HH	264	174/	/2723
2721.3.6M	High-beam***	11' 9 3/4"	3.6	Slide bolt		90.1 2554	5HH	264	174/	/2723
Retrofit 4" Hole Spacing Track										
373.6	Low-beam	6'	1.83	4	102	28 787	10FH 5FH	263/E2200	173/446‡‡	2724/2722
373.12	Low-beam	12'	3.66	4	102	56 1574	10FH 5FH	263/E2200	173/446‡‡	2724/2722
374.4	High-beam	4'	1.22	4	102	25 709	10FH 5FH	264	174/	/2723
374.6	High-beam	6'	1.83	4	102	38 1077	10FH 5FH	264	174/	/2723
374.12	High-beam***	12'	3.66	4	102	76 2143	10FH 5FH	264	174/	/2723

*First mounting hole distance from end of track: Metric track = 50 mm (1 31/32"); Retrofit 4" hole spacing track = 51 mm (2").

#10 (5 mm) FH fasteners. ‡Sold in pairs. ‡‡Fastens directly to deck. *Contact Harken.

22 mm Small Boat: CB Cars

Small Boat CB traveler cars fit dinghies, keelboats, beachcats, and offshore boats to 8 m (27').

About CB traveler cars: see feature pages at beginning of this section.



Block not included

2726
2727



Loop cars matched with 29 or 40 mm Carbo T2 blocks attached with high-tech line provide the ultimate lightweight, low-profile system.



Blocks attach directly to the toggle for a low-profile, compact system.

Pivoting shackle and toggle cars have low pivot points to handle nonvertical loads.

The 382 radial traveler car has a curved ball race to fit curved track—perfect for radial vang on boats like the Star.

Delrin is a registered trademark of E. I. du Pont de Nemours and Company or its affiliates.

Part No.	Description	Length		Width		Car body Height		Weight	Mainsheet block pin Ø	Control block pin Ø	Maximum working load		Breaking load				
		in	mm	in	mm	in	mm				oz	g	in	mm	lb	kg	lb
382	High-load/radial/shackle‡	4 1/8	105	2 1/4	57	15/16	24	6.24	177			1250	567	2500	1134		
2726*	Low-load/pivoting shackle**	2 7/8	73	2 1/4	57	15/16	24	4.64	132			500	227	2500	1134		
2727*	Pivoting shackle	2 7/8	73	2 1/4	57	15/16	24	4.64	132			850	386	2500	1134		
2728*	Low-load/fixed sheaves/eyestraps**	2 7/8	73	2 1/4	57	15/16	24	5.6	159			500	227	2500	1134		
2729	Fixed sheaves/eyestraps	2 7/8	73	2 1/4	57	15/16	24	5.6	159			850	386	2500	1134		
2730	Low-load/stand-up toggle**	2 7/8	73	2 1/4	57	15/16	24	5.12	145	3/16	5	5/32	4	500	227	2500	1134
2731	Stand-up toggle	2 7/8	73	2 1/4	57	15/16	24	5.12	145	3/16	5	5/32	4	850	386	2500	1134
2732	Low-load/loop**	2 7/8	73	2 1/4	57	15/16	24	4	113			500	227	2500	1134		
2733	Loop	2 7/8	73	2 1/4	57	15/16	24	4	113			850	386	2500	1134		
2734	Fixed sheaves/adjustable arms/365 Carbo-Cam	6 3/4	171	3 1/8	80	15/16	24	14.88	422			850	386	2500	1134		
2735*	High-load/pivoting toggle	4 1/8	105	2 1/4	57	15/16	24	6.72	191	1/4	6	5/32	4	1250	567	2500	1134
2736*	High-load/fixed sheaves/eyestraps	4 1/8	105	2 1/4	57	15/16	24	7.04	200			1250	567	2500	1134		
2753	Low-load/pivoting shackle/control tangs**	2 7/8	73	2 1/4	57	15/16	24	5.28	150	3/16	5	500	227	2500	1134		
2754*	Pivoting shackle/control tangs	2 7/8	73	2 1/4	57	15/16	24	5.28	150	3/16	5	850	386	2500	1134		
2756	Pivoting sheaves/471 Carbo-Cam	2 7/8	73	2 1/4	57	15/16	24	9.84	279			850	386	2500	1134		
2757*	High-load/pivoting sheaves/365 Carbo-Cam/eyestraps	4 1/8	105	2 1/4	57	15/16	24	14.18	401			1250	567	2500	1134		
2765	High-load/pivoting sheaves/eyestraps	4 1/8	105	2 1/4	57	15/16	24	9.6	272			1250	567	2500	1134		
2766	High-load/pivoting sheaves/swivel/150 Cam-Matic	4 1/8	105	6 1/8	156	15/16	24	22.22	630			1250	567	2500	1134		

*Available as a non-CB car on a car loader to run on a non-CB style track supplied before 2002. Add .NW to end of part number.

**Small Boat low-load cars with a 227 kg (500 lb) maximum working load use Delrin® balls. See page 275 for replacement balls.

‡For horizontal curved track only—600–800 mm (24"–40") radius. This car cannot be modified to run on old-style track made before 2003.

22 mm Small Boat: End Controls

About Carbo ball bearing or ESP sleeve bearing end controls: see feature pages at beginning of this section.



Carbo ball bearing end controls have an integrated bar for deadending control line.



Assemblies secure to track, eliminating additional holes.

Tough one-piece bases and cam arms are machined from a single piece of aluminum.



2741



Boomerang[®], Tofinou 8, 8 m (26.25'), Chantier Naval Latitude 46, naval architect: Joubert / Nivelte © Chantier Naval Latitude 46



2740

2742



2743



2755



E2230



E2250

CARBO BALL BEARING END CONTROLS

ESP SLEEVE BEARING END CONTROLS

Part No.	Description	Sheave Ø		Length		Width		Weight (pair)		Max line Ø		Height above track		Maximum working load		Breaking load		Purchase	
		in	mm	in	mm	in	mm	oz	g	in	mm	in	mm	lb	kg	lb	kg		
2740	Single sheave (pair)	1 1/8	29	3 7/16	87	1 3/8	35	8	228	5/16	8	1 1/32	26	300	136	600	272	2:1	
2741	Single sheave/471 Carbo-Cam (pair)	1 1/8	29	3 7/16	87	3 1/8	80	10.8	306	1/4	6	1 1/16	28	300	136	600	272	2:1	
2742	Double sheave (pair)	1 1/8	29	3 7/16	87	1 3/8	35	10.3	292	5/16	8	1 5/8	41	600	272	1200	544	3:1 / 4:1	
2743	Double sheave/471 Carbo-Cam (pair)	1 1/8	29	3 7/16	87	3 1/8	80	13	370	1/4	6	1 5/8	41	600	272	1200	544	3:1 / 4:1	
2755	Pinstop*			1 5/8	42	1 3/8	35	1.6**	45**			13/16	21						
ESP Sleeve Bearing End Controls																			
E2230	Single sheave/deadend (pair)	1	25	3 1/2	89	1 1/2	38	4.4	126	5/16	8	1	25	600	272	1200	544	1:1 / 2:1	
E2250	Double sheave/deadend (pair)	1	25	3 1/2	89	1 1/2	38	5	142	5/16	8	1 5/8	41	600	272	1200	544	3:1 / 4:1	

*Use with 2751 Small Boat pinstop track. **Weight each.

22 mm Small Boat: Car Accessories

Accessories

The 384 traveler block features high-load composite bearings to handle wire and high-strength line.

Stand-up toggles hold blocks upright on travelers. Control tangs allow attachment of control blocks.

Refer to stand-up toggles chart for mainsheet block compatibility. See purchase selection guide for control blocks.

Replacement Traveler Kits

Replacement traveler kits are the easiest way to restore modern traveler function. Kits come in two purchase options with prematched parts for easy retrofits.



Use the 384 traveler block with the 382 radial traveler car to configure a radial vang. Do not use as mainsheet traveler.



ACCESSORIES

Accessories

Part No.	Description	Sheave Ø		Length		Width		Weight (pair)		Max line Ø		Maximum working load		Breaking load		Purchase
		in	mm	in	mm	in	mm	oz	g	in	mm	lb	kg	lb	kg	
175	Coupler			3 11/16	94	2 3/16	56	4.5**	128**			1500	680	2500	1134	
384	Wire high-load vang block*	2	51	2 3/4	70			3.3**	93**	1/4	6	1250	567	2500	1134	
2749	Control tangs (pair)			7/8	23			0.8	21			600	272	1200	544	2:1
2759	Padeye/fits 22 mm cars with sheaves			2 1/4	56	3/4	18	1.3**	38**							

*Fits 382 for radial vang system. Do not use with controls if radius is tight. Max wire Ø = 5 mm (3/16"). **Weight each.

Stand-Up Toggles

Part No.	Description	Mainsheet block pin Ø		Control block pin Ø		Height		Weight		Maximum working load		Accepts mainsheet blocks
		in	mm	in	mm	in	mm	oz	g	lb	kg	
2747	Small stand-up toggle/control tangs	3/16	5	5/32	4	1 13/16	45	1.5	43	1250	567	40 mm double & triple Carbo, 57 mm single & fiddle Carbo
2748	Large stand-up toggle/control tangs	1/4	6	5/32	4	2	51	2	48	1250	567	57 mm double & triple Carbo

Replacement Traveler Kits

Part No.	Description	Boat length				Max mainsail area				Maximum working load		Purchase	Includes
		Mid-boom		End-boom		Mid-boom		End-boom		lb	kg		
		ft	m	ft	m	ft²	m²	ft²	m²				
2763	22 mm traveler kit/2:1	18 - 22	5.5 - 6.7	21 - 25	6.4 - 7.6	125	11.5	150	14	850	386	2:1	(1) 2729, (1 pair) 2741
2764	22 mm traveler kit/3:1	21 - 26	6.4 - 7.9	24 - 29	7.3 - 8.8	150	14	190	17.5	1250	567	3:1	(1) 2735, (2) 348, (1 pair) 2743

22 mm Small Boat: Purchase Selection Guide

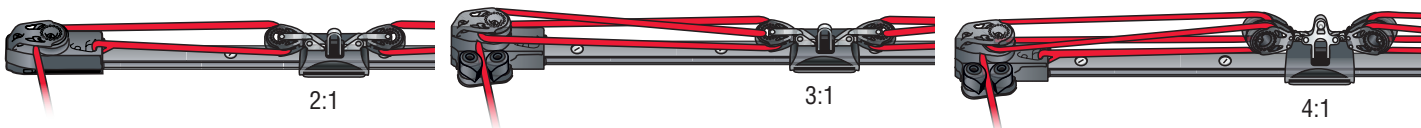

Purchase	Car	End control	Control block (cars with stand-up toggles or control tangs only)
2:1	2728 / 2729 / 2730 / 2731 / 2734 / 2753 / 2754 / 2735 / 2736 / 2737 / 2738	2740 / 2741	340 / 348 / 2608 / 2636 / 2650 / 2149
3:1	2730 / 2731 / 2753 / 2754 / 2735	2742 / 2743	340* / 341 / 348* / 2609 / 2636* / 2637 / 2650*
4:1	2730 / 2731 / 2753 / 2754 / 2735	2742 / 2743	342 / 2638 / 2642

*Deadend line through center of sheave.

22 mm Small Boat: Genoa Lead Cars

CB adjustable genoa lead cars feature recirculating Torton® ball bearings for easy adjustment under full sheet loads.

Stainless steel sheave carriers pivot 60 degrees to accommodate changing lead angles. Wide sheave holds two sheets during sail changes.

Cars feature car-mounted, sleeve-bearing control blocks for strength and durability. All CB genoa lead cars are compatible with Harken end controls. Kits are available for purchase upgrades up to 4:1.

CB Adjustable Cars

Sheave carriers feature high-performance sheaves with ball bearings to handle radial loads, while sideload balls handle thrust loads for easy trimming and fore-and-aft adjustment.

ESP CB Adjustable & Pinstop Cars

Sheave carriers feature ESP sleeve bearing sheaves.

Use pinstop cars in applications where lead positions change infrequently.

Pinstop and ball bearing genoa lead cars both run on ball bearing track, allowing system upgrades without changing track.

Torton is a registered trademark of Solvay Advanced Polymers L.L.C.



Flexible, lightweight, lashing attachment allows block to articulate freely on 2750 jib car.

GENOA LEADS Q&A

WHY DO I NEED ADJUSTABLE GENOA LEAD CARS?

If you are a cruiser, ball bearing genoa lead cars with multipart purchases allow you to quickly adjust loaded headsail leads from the cockpit. If you race, ball bearing lead cars let you quickly change your sheeting angle, adjusting the twist to optimize sail shape.



CB ADJUSTABLE

ESP CB ADJUSTABLE



ESP PINSTOP

For sheet-loading formulas see page 279

End control selection guide

Purchase	Car	End Control
2:1	G2227B/G222B	2740
4:1	G2247B/G224B	2742

Part No.	Description	Sheave Ø		Length		Width		Weight		Maximum working load		Breaking load		Track
		in	mm	in	mm	in	mm	oz	g	lb	kg	lb	kg	
CB Adjustable														
G2227B*	Small Boat/sheave	1 3/4	45	4 1/8	105	2 1/4	57	13.71	389	1250	567	2500	1134	22 mm
G2247B	Small Boat/2 sheaves	1 3/4	45	4 1/8	105	2 1/4	57	14.3	405	1250	567	2500	1134	22 mm
ESP CB Adjustable														
G222B	Small Boat/sheave	1 1/2	38	4 1/8	105	2 1/4	57	12.87	365	1250	567	2500	1134	22 mm
G224B	Small Boat/2 sheaves	1 1/2	38	4 1/8	105	2 1/4	57	13.33	378	1250	567	2500	1134	22 mm
ESP Pinstop														
2750	Small Boat jib lead/pinstop			3 7/16	88	1 5/16	33	4.6	130	1100	500	2200	1000	2751
G226S	Small Boat/pinstop	1 1/2	38	3 3/4	95	1 3/8	35	9.59	272	1250	567	2500	1134	2751

*Available as a non-CB car on a car loader to run on a non-CB style track supplied before 2002. Add .NW to end of part number. See page 276 for replacement balls.

27 mm Midrange: CB Track & Accessories

Variable Hole Spacing Track

CB (Captive Ball) high-beam variable hole spacing track is used to span cockpits or other unsupported areas. Track features internal slide bolts, allowing new track to be installed without drilling additional holes.

Low-Beam Track

Low-beam track is available with one, two, or three pinstop holes between fasteners or without pinstop holes.

Endstops/Trim Caps

When end controls are not used, add endstops to absorb shock loads. When end control assemblies are used, trim caps finish track ends. Sold in pairs. Fasteners not included.

Splice Links

Splice links join track and keep it aligned during installation.

Track Risers

Use 1849 risers for mid-boom travelers that must clear companionway hatches. Risers fit most cabintops and articulate for use with either straight or curved track.

Curved Track

Harken will bend track to your specifications. See page 127.

Track bending

Car	Minimum radius			
	Horizontal bend		Vertical bend	
	ft	m	ft	m
T27xxB, T2701B.NW, T27x4B.HL, 1635	8	2.44	8	2.44
T27xxB.HL, T2701B.HL.NW, 1636	9	2.73	9	2.73

Track Risers

Part No.	Description	Fits	Weight		A		B		C		D		E		F	
			oz	g	in	mm	in	mm	in	mm	in	mm	in	mm	in	mm
1849	Track riser (pair)	R27HB, R32HB	131.2	3720	6 7/8	175	9 9/16	243	6 11/16	170	4 5/16	110	1 3/4	45	3	76

Part No.	Description	Length	Mounting hole spacing*	Weight	Fasteners	Endstop**/trim cap**	Splice link/track riser

Metric Track

R27.1M	Low-beam/pinstop holes	3' 3 3/8"	1	3 15/16	100	22	0.62	5/16FH	8FH	1522/E2700/1621	1619/
R27.1MHDP	Low-beam/3 pinstop holes	3' 3 3/8"	1	3 15/16	100	21.3	0.61	5/16FH	8FH	1522/E2700/1621	1619/
R27.1.2M	Low-beam/pinstop holes	3' 11 1/4"	1.2	3 15/16	100	26.5	0.75	5/16FH	8FH	1522/E2700/1621	1619/
R27.1.5M	Low-beam/pinstop holes	4' 11 1/16"	1.5	3 15/16	100	33	0.93	5/16FH	8FH	1522/E2700/1621	1619/
R27.1.8M	Low-beam/pinstop holes	5' 10 13/16"	1.8	3 15/16	100	39	1.11	5/16FH	8FH	1522/E2700/1621	1619/
R27.2M	Low-beam/pinstop holes	6' 6 3/4"	2	3 15/16	100	44	1.24	5/16FH	8FH	1522/E2700/1621	1619/
R27.2.5M	Low-beam/pinstop holes	8' 2 7/16"	2.5	3 15/16	100	55	1.56	5/16FH	8FH	1522/E2700/1621	1619/
R27.3M	Low-beam/pinstop holes	9' 10 1/16"	3	3 15/16	100	66	1.87	5/16FH	8FH	1522/E2700/1621	1619/
R27.3.6M	Low-beam/pinstop holes	11' 9 3/4"	3.6	3 15/16	100	79	2.24	5/16FH	8FH	1522/E2700/1621	1619/
R27.6M	Low-beam/pinstop holes	19' 8 1/4"	6	3 15/16	100	132	3.74	5/16FH	8FH	1522/E2700/1621	1619/

Variable Hole Spacing Track

R27HB.1M	High-beam	3' 3 3/8"	1	Slide bolt	57	1.63	1/4HH	6HH	1523/1622	/1849
R27HB.1.5M	High-beam	4' 11 1/16"	1.5	Slide bolt	86	2.45	1/4HH	6HH	1523/1622	/1849
R27HB.1.8M	High-beam	5' 10 7/8"	1.8	Slide bolt	104	2.93	1/4HH	6HH	1523/1622	/1849
R27HB.2.5M	High-beam	8' 2 7/16"	2.5	Slide bolt	144	4.08	1/4HH	6HH	1523/1622	/1849
R27HB.3.6M	High-beam***	11' 9 3/4"	3.6	Slide bolt	207	5.87	1/4HH	6HH	1523/1622	/1849

Retrofit 4" Hole Spacing Track

1602.8	Low-beam	8'	2.44	4	102	56	1.59	1/4FH	6FH	1522/E2700/1621	1619/
1602.12	Low-beam	12'	3.66	4	102	83	2.35	1/4FH	6FH	1522/E2700/1621	1619/
1605.4	Low-beam/2 pinstop holes	4'	1.22	4	102	26.9	0.76	1/4FH	6FH	1522/E2700/1622	1619/
1605.6	Low-beam/2 pinstop holes	6'	1.83	4	102	40.3	1.14	1/4FH	6FH	1522/E2700/1622	1619/

*First mounting hole distance from end of track: Metric track = 50 mm (1 31/32"); Retrofit 4" hole spacing track = 51 mm (2").

Sold in pairs. Trim caps not used with E27 end controls. *Contact Harken.

27 mm High-Beam Track Spanning Chart

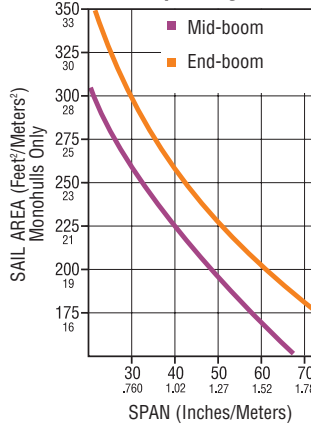

R27HB

R27
1605

1602

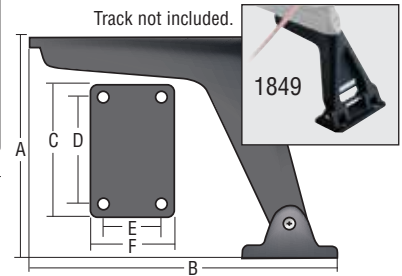
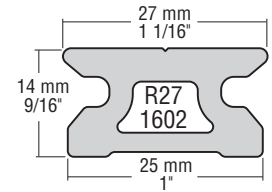
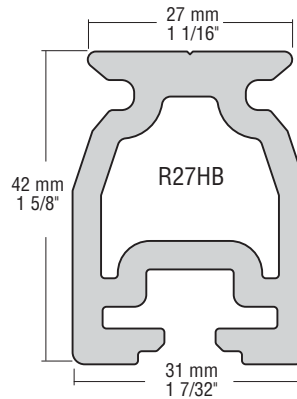

27 mm Midrange: CB Cars

Midrange CB traveler cars are built to handle high loads on boats from 8 m to 10 m (27' to 34').

About CB traveler cars: see feature pages at beginning of this section.



Carbo ball bearing controls

For a ball bearing system, use separate Carbo control blocks mounted on the stand-up toggle control tangs to add up to 4:1 purchase. See page 112.



ESP sleeve bearing controls

For an ESP sleeve-bearing system, use a T27KIT control block kit mounted on the car to add up to 4:1 purchase. See page 112.



T2703B

T2703B.HL



T2701B

T2701B.HL



T2705B.HL

T2705B



T2721B.HL

T2731B.HL

T2741B.HL

T2751B

T2721B

T2731B

T2741B

T2704B.HL



T2705B and T2705B.HL lightweight soft-attachment cars provide a variety of rigging solutions—athwartship jib or mainsheet systems, for example. Lash Carbo T2 blocks to the car for traveler control.

Complete selection of cars with built-in car control blocks is available online: www.harken.com/27mm-cars

Part No.	Description	Length		Width		Height		Weight		Mainsheet block pin Ø		Control block pin Ø		Maximum working load		Breaking load	
		in	mm	in	mm	in	mm	oz	g	in	mm	in	mm	lb	kg	lb	kg
27 mm Midrange Standard																	
T2701B*	Car/shackle	4 1/4	108	2 3/4	70	2	50	11.04	313					1800	816	5000	2268
T2703B	Car/stand-up toggle/ears	4 1/4	108	2 3/4	70	3 1/8	80	14.4	408	1/4, 5/16	6, 8	3/16	5	1800	816	5000	2268
T2705B	Car/soft attachment	4 1/4	108	2 3/4	70	1 1/2	38	10.06	285					1800	816	5000	2268
T2721B	Car/shackle/2:1 ESP controls	4 1/4	108	3	76	2	50	11.04	313					1800	816	5000	2268
T2731B	Car/shackle/3:1 ESP controls	4 1/4	108	3 7/32	81	2	50	11.04	313					1800	816	5000	2268
T2741B	Car/shackle/4:1 ESP controls	4 1/4	108	3 3/8	86	2	50	11.04	313					1800	816	5000	2268
T2751B	Car/shackle/5:1 ESP controls	4 1/4	108	3 9/16	91	2	50	12.7	360					1800	816	5000	2268
27 mm Midrange High-Load																	
T2701B.HL*	High-load car/shackle	5 3/16	132	2 3/4	70	2	50	12.48	354					2300	1043	5000	2268
T2703B.HL	High-load car/stand-up toggle/ears	5 3/16	132	2 3/4	70	3 1/8	80	15.84	449	1/4, 5/16	6, 8	3/16	5	2300	1043	5000	2268
T2704B.HL	2 cars/2 stand-up toggles	8 3/4	223	2 3/4	70	3 1/8	80	25.6	726	1/4, 5/16	6, 8			3600	1633	7200	3266
T2705B.HL	High-load car/soft attachment	5 3/16	132	2 3/4	70	1 1/2	38	12.28	348					2300	1043	5000	2268
T2721B.HL	High-load car/shackle/2:1 ESP controls	5 3/16	132	3	76	2	50	12.48	354					2300	1043	5000	2268
T2731B.HL	High-load car/shackle/3:1 ESP controls	5 3/16	132	3 7/32	81	2	50	12.48	354					2300	1043	5000	2268
T2741B.HL	High-load car/shackle/4:1 ESP controls	5 3/16	132	3 3/8	86	2	50	12.48	354					2300	1043	5000	2268

*Available as a non-CB car on a car loader to run on a non-CB style track supplied before 2003. Add .NW to end of part number.

See page 275 for replacement balls.

27 mm Midrange: End Controls

About Carbo ball bearing or ESP sleeve bearing end controls: see feature pages at beginning of this section.

Pogo 36, 10.86 m (36'), Pogo Structures, naval architect: FINOT-CONQ © Andreas Lindlahr



1631



PINSTOPS

1649

1642



1632



1633



1652

CARBO BALL BEARING END CONTROLS



E2730



E2750



E2756



E2750HB

ESP SLEEVE BEARING END CONTROLS



Carbo ball bearing end controls have an integrated bar for deadending control line.



Assemblies secure to track, eliminating additional holes.

Tough one-piece bases and cam arms are machined from a single piece of aluminum.



Use E2750HB double-sheave ESP end controls for cabintop travelers where lines lead to the aft edge of the cabintop.

Contact Harken to order special length track with mounting holes for E2750HB end controls.

Fasteners not included.

Part No.	Description	Sheave Ø		Length		Width		Weight (pair)		Max line Ø		Height above track		Maximum working load		Breaking load		Purchase	
		in	mm	in	mm	in	mm	oz	g	in	mm	in	mm	lb	kg	lb	kg		
Carbo Ball Bearing End Controls																			
1631	Single sheave (pair)*	1 9/16	40	4 1/2	114	1 15/16	49	20	574	3/8	10	1 5/16	33	350	159	875	397	2:1 / 3:1	
1632	Double sheave (pair)*	1 9/16	40	4 1/2	114	1 15/16	49	26	730	3/8	10	2	50	700	318	1750	794	3:1 / 4:1	
1633	Double sheave/365 Carbo-Cam (pair)*	1 9/16	40	4 1/2	114	3 15/16	100	36	1020	3/8	10	2	50	600	272	1500	680	3:1 / 4:1	
1652	Self-tacking jib controls (pair)***	2	51	4 3/16	106	2 1/4	57	20.4	578	1/2	12	2 5/16	59	610	277	1200	544	1:1	
ESP Sleeve Bearing End Controls																			
E2730	Single sheave/deadend (pair)	1 3/8	35	4 13/16	122	1 13/16	45	19.54	554	3/8	10	1 7/16	36	1800	816	3600	1633	1:1 / 2:1	
E2750HB	High-beam double sheave (pair)‡	1 9/16	40	4 1/4	108	1 9/16	40	23.4	662	3/8	10	1	25	600	272	1200	544	3:1 / 4:1	
E2750	Double sheave/deadend (pair)	1 3/8	35	4 13/16	122	1 13/16	45	24.2	686	3/8	10	2 1/4	56	1800	816	3600	1633	3:1 / 4:1	
E2756	Double sheave/deadend/365 Carbo-Cam (pair)‡‡	1 3/8	35	3 3/4	95	3 13/16	96	23.4	1278	3/8	10	2 1/4	56	600	272	1500	680	4:1	
Pinstops																			
1642	Pinstop			2 5/16	59	1 15/16	49	4.8**	136**			1 5/16	33						
1649	Pinstop/shackle			3 1/2	89	1 15/16	49	9.95**	282**					1984	900	3968	1800		

*Includes 8 mm PH fasteners. **Weight each. ***Includes 5/16" RH fasteners. ‡Requires high-beam track. ‡‡Maximum working loads and breaking loads based on cam strengths.

27 mm Midrange: Car Accessories

Control Block Kits

Kits are available for Midrange cars to add sleeve-bearing control systems for up to 4:1 purchase. Combine with sleeve-bearing end controls.

Stand-Up Toggles

Stand-up toggles hold blocks upright on travelers. Control tangs allow attachment of ball bearing Carbo control blocks.

Refer to stand-up toggles chart for mainsheet block compatibility. See purchase selection guide for control blocks.

Replacement Traveler Kits

Replacement traveler kits are the easiest way to restore modern traveler function. Kits come in two purchase options with prematched parts for easy retrofits.



1654



1655

REPLACEMENT TRAVELER KITS



1567



1643

STAND-UP TOGGLES



2650

2638

See page 23-24



T27KIT
T32KIT

Control Block Kits

Part No.	Description	Includes
T27KIT	Purchase upgrade kit	(4) 25 mm control blocks, (2) Small Boat deadends, (8) M5 fasteners
T32KIT	Purchase upgrade kit*	(4) 35 mm control blocks, (2) Midrange/Big Boat deadends, (8) M6 fasteners

*Use with G27 genoa lead cars.

Replacement Traveler Kits

Part No.	Description	Boat length				Max mainsail area				Maximum working load		Purchase	Includes
		Mid-boom ft	End-boom ft	Mid-boom m	End-boom m	Mid-boom ft ²	End-boom ft ²	Mid-boom m ²	End-boom m ²	lb	kg		
1654	27 mm traveler kit/3:1	26 - 28	7.9 - 8.5	28 - 30	8.5 - 9.1	190	17.5	220	20.5	1800	816	3:1	(1) T2731B, (1 pair) E2756
1655	27 mm traveler kit/4:1	28 - 31	8.5 - 9.5	31 - 35	9.5 - 10.7	215	20	260	24	1800	816	4:1	(1) T2741B, (1 pair) E2756

Stand-Up Toggles

Part No.	Description	Mainsheet block pin Ø		Control block pin Ø		Height		Maximum working load		Accepts mainsheet blocks
		in	mm	in	mm	in	mm	lb	kg	
1567	Stand-up toggle	1/4, 5/16	6, 8			2 5/16	59	2500	1134	45 & 60 mm Element singles, doubles, triples; 75 mm Carbo singles, doubles, triples; 3" Small Boat single, fiddle, Midrange blocks; 57 mm single Black Magic
1643	Stand-up toggle/control tangs	1/4, 5/16	6, 8	3/16	5	2 5/16	59	2500	1134	

27 mm Midrange: Purchase Selection Guide

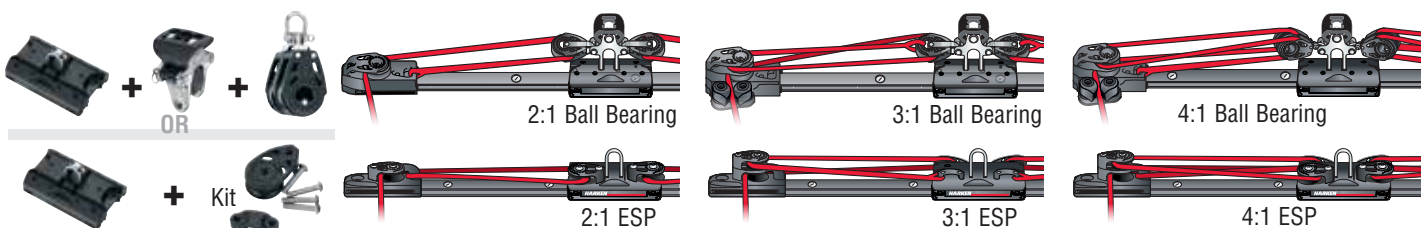

Purchase	Car	End control	Control block on car
2:1 Ball bearing	T2701B	1631	1643 with 2650
2:1 ESP	T2701B	E2730	T27KIT
3:1 Ball bearing	T2701B	1632, 1633	1643 with 2650*
3:1 ESP	T2701B	E2750, E2756	T27KIT
4:1 Ball bearing	T2701B	1632, 1633	1643 with 2638
4:1 ESP	T2701B	E2750, E2756	T27KIT

Control purchase recommendations				
Sail area				
End-boom sheeting		Mid-boom sheeting		Purchase
ft ²	m ²	ft ²	m ²	
Under 140	Under 13	Under 125	Under 12	2:1
140-235	13-22	125-200	12-19	3:1
235-275	22-25	200-250	19-23	4:1

*Deadend line through center of sheave.

27 mm Midrange: Genoa Lead Cars

CB adjustable genoa lead cars feature recirculating Torlon® ball bearings for easy adjustment under full sheet loads.

Stainless steel sheave carriers pivot 60 degrees to accommodate changing lead angles. Wide sheave holds two sheets during sail changes.

Cars feature car-mounted, sleeve-bearing control blocks for strength and durability. All CB genoa lead cars are compatible with Harken end controls. Kits are available for purchase upgrades up to 4:1.

CB Adjustable Cars

Sheave carriers feature high-performance sheaves with roller bearings to handle radial loads, while sideload balls handle thrust loads for easy trimming and fore-and-aft adjustment.

ESP CB Adjustable & Pinstop Cars

Sheave carriers feature ESP sleeve-bearing sheaves.

Use pinstop cars in applications where lead positions change infrequently.

Pinstop and ball bearing genoa lead cars both run on ball bearing track, allowing system upgrades without changing track.



ESP PINSTOP



Torlon is a registered trademark of Solvay Advanced Polymers L.L.C.



CB ADJUSTABLE



ESP CB ADJUSTABLE

27 mm Midrange: Genoa Lead Cars



N Fun 30, 9.14 m (30'), naval architect: Eugeniusz Ginter © Tomasz Karolski / N Fun Yachting sp zoo

For sheet-loading formulas see page 279.

End control selection guide		
Purchase	Car	End control
2:1	G272B/G2727B	E2730
3:1	G273B/G273B.HL/G2737B/G2737B.HL	E2750
4:1	G274B/G274B.HL/G2747B/G2747B.HL	E2750

Part No.	Description	Sheave Ø		Length		Width		Weight		Maximum working load		Breaking load		Track
		in	mm	in	mm	in	mm	oz	g	lb	kg	lb	kg	
CB Adjustable														
G2727B	Midrange/sheave	2 1/2	64	5 3/16	132	2 3/4	70	27.52	780	2300	1043	5000	2268	R27
G2737B	Midrange/sheave/deadend	2 1/2	64	5 3/16	132	2 3/4	70	28.4	805	2300	1043	5000	2268	R27
G2737B.HL	High-load Midrange/sheave/deadend	2 1/2	64	9 1/8	232	2 3/4	70	39.25	1113	3600	1633	7200	3266	R27
G2747B*	Midrange/2 sheaves	2 1/2	64	5 3/16	132	2 3/4	70	29.76	844	2300	1043	5000	2268	R27
G2747B.HL	High-load Midrange/2 sheaves	2 1/2	64	9 1/8	232	2 3/4	70	40.64	1152	3600	1633	7200	3266	R27
ESP CB Adjustable														
G272B	Midrange/sheave	2 1/4	57	5 3/16	132	2 3/4	70	23.25	659	2300	1043	5000	2268	R27
G273B	Midrange/sheave/deadend	2 1/4	57	5 3/16	132	2 3/4	70	24.06	682	2300	1043	5000	2268	R27
G273B.HL	High-load Midrange/sheave/deadend	2 1/4	57	9 1/8	232	2 3/4	70	34.6	981	3600	1633	7200	3266	R27
G274B	Midrange/2 sheaves	2 1/4	57	5 3/16	132	2 3/4	70	25.22	718	2300	1043	5000	2268	R27
G274B.HL	High-load Midrange/2 sheaves	2 1/4	57	9 1/8	232	2 3/4	70	35.76	1017	3600	1633	7200	3266	R27
ESP Pinstop														
G276S	Midrange/pinstop	2	51	5	127	1 5/8	41	17.92	508	3000	1361	6000	2722	R27
G276S.HL	High-load Midrange/pinstop	2	51	7 1/4	184	1 5/8	41	22.93	650	3600	1633	7200	3266	R27

* Available as a non-CB car on a car loader to run on a non-CB style track supplied before 2003. Add .NW to end of part number.

See page 276 for replacement balls.

32 mm Big Boat: CB Track & Accessories

Variable Hole Spacing Track

CB (Captive Ball) high-beam variable hole spacing track is used to span cockpits or other unsupported areas. Track features internal slide bolts, allowing new track to be installed without drilling additional holes.

Low-Beam Track

Low-beam track is available with one, two, or three pinstop holes between fasteners or without pinstop holes.

Endstops/Trim Caps

When end controls are not used, add endstops to absorb shock loads. When end control assemblies are used, trim caps finish track ends. Sold in pairs. Fasteners not included.

Splice Links

Splice links join track and keep it aligned during installation.

Track Risers

Use 1849 risers for mid-boom travelers that must clear companionway hatches. Risers fit most cabintops and articulate for use with either straight or curved track.

Curved Track

Harken will bend track to your specifications. See page 127.

Track bending

Car	Minimum radius			
	Horizontal bend		Vertical bend	
	ft	m	ft	m
T32xxB*, T32xxB.NW, 3176, 3177	8	2.44	10	3.05
T32xxB.HL, T32x4B.HL T32xxB.HL.NW, 3178, 3179	18	5.49	18	5.49
2 x T32xxB, 2 x T32xxB.NW	8	2.44	10	3.05
T3204B, T3209B	24	7.32	24	7.32

*T3204B/T3209B: 7.32 m (24')

Part No.	Description	Length ft/in	m	Mounting hole spacing*		Weight oz	kg	Fasteners in	mm	Endstop**/ trim cap**	Splice link/ track riser†
				in	mm						
Metric Track											
R32.1M	Low-beam/pinstop holes	3' 3 3/8"	1	3 15/16	100	52	1.47	3/8FH	10FH	548/E3200/3157	3153/
R32.1MHDP	Low-beam/3 pinstop holes	3' 3 3/8"	1	3 15/16	100	33.1	0.94	5/16FH	8FH	548/E3200/3157	3153/
R32.1.5M	Low-beam/pinstop holes	4' 11 1/16"	1.5	3 15/16	100	52	1.47	3/8FH	10FH	548/E3200/3157	3153/
R32.1.8M	Low-beam/pinstop holes	5' 10 13/16"	1.8	3 15/16	100	61.7	1.75	3/8FH	10FH	548/E3200/3157	3153/
R32.2.1M	Low-beam/pinstop holes	6' 10 11/16"	2.1	3 15/16	100	72	2.05	3/8FH	10FH	548/E3200/3157	3153/
R32.2.4M	Low-beam/pinstop holes	7' 10 1/2"	2.4	3 15/16	100	81	2.3	3/8FH	10FH	548/E3200/3157	3153/
R32.3M	Low-beam/pinstop holes	9' 10 1/16"	3	3 15/16	100	103	2.93	3/8FH	10FH	548/E3200/3157	3153/
R32.3.6M	Low-beam/pinstop holes	11' 9 3/4"	3.6	3 15/16	100	124	3.52	3/8FH	10FH	548/E3200/3157	3153/
R32.6M	Low-beam/pinstop holes	19' 8 1/4"	6	3 15/16	100	207	5.87	3/8FH	10FH	548/E3200/3157	3153/
Variable Hole Spacing Track											
R32HB.1.5M	High-beam	4' 11 1/16"	1.5		Slide bolt	167	4.74	5/16HH	8HH	562/3158	/1849
R32HB.1.8M	High-beam	5' 10 7/8"	1.8		Slide bolt	201	5.69	5/16HH	8HH	562/3158	/1849
R32HB.2.5M	High-beam	8' 2 7/16"	2.5		Slide bolt	279	7.9	5/16HH	8HH	562/3158	/1849
R32HB.3.6M	High-beam***	11' 9 3/4"	3.6		Slide bolt	402	11.38	5/16HH	8HH	562/3158	/1849
R32HB.4.5M	High-beam***	14' 9 3/16"	4.5		Slide bolt	502	14.23	5/16HH	8HH	562/3158	/1849
Retrofit 4" Hole Spacing Track											
3159.8	Low-beam	8'	2.44	4	102	89	2.48	5/16FH	8FH	548/E3200/3157	3153/
3159.12	Low-beam	12'	3.66	4	102	131	3.71	5/16FH	8FH	548/E3200/3157	3153/
3500.4	Low-beam/2 pinstop holes	4'	1.22	4	102	41.5	1.18	5/16FH	8FH	548/E3200/3157	3153/
3500.6	Low-beam/2 pinstop holes	6'	1.83	4	102	62.2	1.76	5/16FH	8FH	548/E3200/3157	3153/

*First mounting hole distance from end of track: Metric track = 50 mm (1 31/32"); Retrofit 4" hole spacing track = 51 mm (2").

Sold in pairs. Trim caps not used with E32 end controls. †Track riser 1849 shown on page 109. *Contact Harken.

32 mm High-Beam Track Spanning Chart

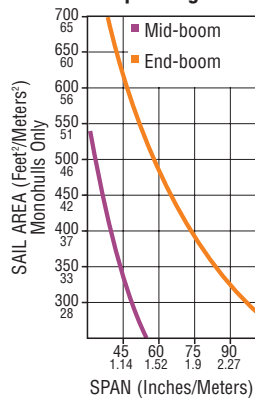

R32HB

R32
3500

3159

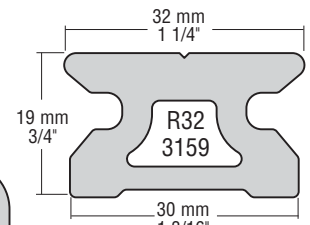
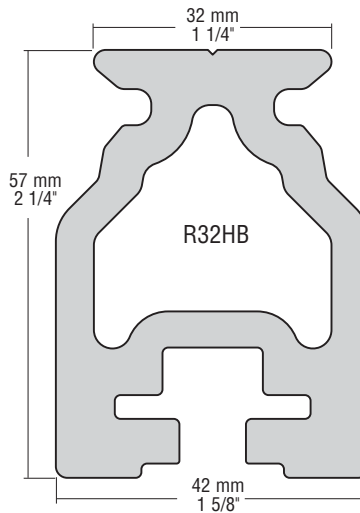

Track not included.

1849

3157

3158



548



E3200



562



3153

32 mm Big Boat: CB Cars

Big Boat CB traveler cars handle high loads on boats from 9.5 m to 15 m (32' to 50') and up to 21 m (70') with coupled cars.

About CB traveler cars: see feature pages at beginning of this section.



Carbo ball bearing controls

For a ball bearing system, use separate Carbo or Black Magic control blocks mounted on the stand-up toggle control tangs to add up to 6:1 purchase. See page 120.



ESP sleeve bearing controls

For an ESP sleeve-bearing system, use a T32KIT control block kit mounted on the car to add up to 6:1 purchase. See page 120.



T3203B

T3203B.HL



T3201B.HL

T3201B

T3209B

T3204B

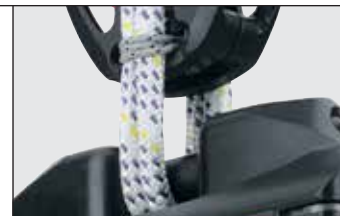

T3205B and T3205B.HL lightweight soft-attachment cars provide a variety of rigging solutions—athwartship jib or mainsheet systems, for example. Lash Carbo T2 or Black Magic Loop blocks to the car for traveler control.



T3205B.HL

T3205B



Complete selection of cars with built-in car control blocks is available online: www.harken.com/32mm-cars



T3221B.HL

T3231B.HL

T3241B.HL

T3221B

T3231B

T3241B

T3209B.HL

T3204B.HL

Part No.	Description	Length		Width		Height		Weight		Mainsheet block pin Ø		Control block pin Ø		Maximum working load		Breaking load	
		in	mm	in	mm	in	mm	oz	g	in	mm	in	mm	lb	kg	lb	kg
32 mm Big Boat Standard																	
T3201B*	Car/shackle	5 3/8	136	3 11/32	85	2 5/8	73	20	567					3000	1361	7000	3175
T3203B	Car/stand-up toggle/ears	5 3/8	136	3 11/32	85	3 1/2	89	25.28	717	5/16	8	1/4	6	3000	1361	7000	3175
T3204B	Car/2 stand-up toggles	9 1/8	231	3 11/32	85	3 1/2	89	55	1559	5/16	8			5000	2268	10000	4536
T3205B	Car/soft attachment	5 3/8	136	3 11/32	85	2	50	20.43	579					3000	1361	7000	3175
T3209B	Car/2 stand-up toggles/ears	9 1/8	231	3 11/32	85	3 1/2	89	56.44	1600	5/16	8	1/4	6	5000	2268	10000	4536
T3221B	Car/shackle/2:1 ESP controls	5 3/8	136	3 5/8	98	2 5/8	73	20	567					3000	1361	7000	3175
T3231B	Car/shackle/3:1 ESP controls	5 3/8	136	4	101	2 5/8	73	20	567					3000	1361	7000	3175
T3241B	Car/shackle/4:1 ESP controls	5 3/8	136	4 3/8	111	3 1/2	89	20	567					3000	1361	7000	3175
32 mm Big Boat High-Load																	
T3201B.HL*	High-load car/shackle	7 7/16	188	3 11/32	85	2 5/8	73	24	680					4500	2041	9000	4081
T3203B.HL	High-load car/stand-up toggle/ears	7 7/16	188	3 11/32	85	3 1/2	89	29.44	835	5/16	8	1/4	6	4500	2041	9000	4081
T3204B.HL	2 high-load cars/2 stand-up toggles	15	381	3 11/32	85	3 1/2	89	79	2239	5/16	8			9000	4082	18000	8163
T3205B.HL	High-load car/soft attachment	7 7/16	188	3 11/32	85	2	50	29.42	834					4500	2041	9000	4081
T3209B.HL	2 high-load cars/2 stand-up toggles/ears	15	381	3 11/32	85	3 1/2	89	80.25	2275	5/16	8	1/4	6	9000	4082	18000	8163
T3221B.HL	High-load car/shackle/2:1 ESP controls	7 7/16	188	3 5/8	98	2 5/8	73	24	680					4500	2041	9000	4081
T3231B.HL	High-load car/shackle/3:1 ESP controls	7 7/16	188	4	101	2 5/8	73	24	680					4500	2041	9000	4081
T3241B.HL	High-load car/shackle/4:1 ESP controls	7 7/16	188	4 3/8	111	3 1/2	89	24	680					4500	2041	9000	4081

*Available as a non-CB car on a car loader to run on a non-CB style track supplied before 2004. Add .NW to end of part number.

See page 275 for replacement balls.

32 mm Big Boat: End Controls

About Carbo ball bearing or ESP sleeve bearing end controls: see feature pages at beginning of this section.



3170



3168

3169

3197

CARBO BALL BEARING END CONTROLS



3174

3173

3173 and 3174 high-load controls allow 2:1 to 6:1 purchases on offshore boats with mainsails over 37 m² (400 ft²). Controls feature 57 mm Black Magic Big Boat ball/roller sheaves and high-load aluminum sideplates.

HIGH-LOAD END CONTROLS



E3230
E3230.HL

E3250
E3250.HL

E3256

E3250HB

ESP SLEEVE BEARING END CONTROLS



Carbo ball bearing end controls have an integrated bar for deadending control line.



Assemblies secure to track, eliminating additional holes.

Tough one-piece bases and cam arms are machined from a single piece of aluminum.



Use E3250HB double-sheave ESP end controls for cabintop travelers where lines lead to the aft edge of the cabintop.

Contact Harken to order special length track with mounting holes for E3250HB end controls.



3212

3304

3213

PINSTOPS

End Controls: 32 mm Big Boat

TECH TIP

27 mm Midrange and 32 mm Big Boat kits are available for purchase upgrades from 1:1 to 4:1.



Amel 50, 15.24 m (50'), Berret-Racoupeau Yacht Design © Robin Christol

Control Purchase Recommendations				
Sail area				
End-boom sheeting		Mid-boom sheeting		Purchase
ft²	m²	ft²	m²	
Under 260	Under 24	Under 240	Under 22	3:1
260-450	24-42	240-400	22-37	4:1
450-600	42-56	400-550	37-51	6:1
Over 600	Over 56	Over 550	Over 51	2:1 w/winch

Part No.	Description	Sheave Ø		Length		Width		Weight (pair)		Max line Ø		Height above track		Maximum working load		Breaking load		Purchase
		in	mm	in	mm	in	mm	oz	g	in	mm	in	mm	lb	kg	lb	kg	
Carbo Ball Bearing End Controls																		
3168	Single sheave (pair)***	1 9/16	40	4 13/16	122	2 1/4	57	27	767	3/8	10	1 7/16	36	450	204	1600	725	1:1 / 2:1
3169	Double sheave (pair)***	1 9/16	40	4 13/16	122	2 1/4	57	31	887	3/8	10	2	51	900	408	2300	1040	3:1 / 4:1
3170	Double sheave/150 Cam-Matic (pair)***	1 9/16	40	4 13/16	122	4 1/8	104	39	1116	3/8	10	2	51	900	408	2300	1040	3:1 / 4:1
3197	Triple sheave/deadend (pair)	1 3/8, 2 1/4	35, 57	6 3/4	171	2 1/4	57	32.4	918	3/8	10	2 1/2	64	1500	680	2500	1134	5:1 / 6:1
High-Load End Controls																		
3173	High-load single (pair)	2 1/4	57	6 7/16	164	2 1/4	57	35	981	7/16	12	1 1/16	28	2500	1134	5000	2268	1:1 / 2:1
3174	High-load double (pair)	2 1/4	57	6 7/16	164	2 1/4	57	41	1169	7/16	12	1 15/16	49	1650	750	3300	1500	3:1 / 4:1
Pinstops																		
3212	Adjustable pinstop			2 9/16	65	2 1/4	57	8**	227**			1 5/16	33					
3213	Adjustable pinstop/shackle			4 7/16	113	2 1/4	57	15.2**	431**			1 27/32	46	3500	1588			
3304	Adjustable pinstop			2 1/2	64	2 1/4	57	10.3**	294**			1 3/16	30					
ESP Sleeve Bearing End Controls																		
E3230	Single sheave/deadend (pair)	1 3/8	35	4 13/16	122	1 13/16	45	19.54	554	3/8	10	1 7/16	36	1800	816	3600	1633	2:1
E3230.HL	High-load/single sheave/deadend (pair)	1 9/16	40	4 13/16	122	1 13/16	45	23.4	642	3/8	10	1 1/2	40	2500	1134	5000	2268	2:1
E3250HB	High-beam/double sheave (pair)*	2 1/4	57	6 1/8	155	2 1/4	57	54.6	1547	3/8	10	1	25	700	318	1400	635	3:1 / 4:1
E3250	Double sheave/deadend (pair)	1 3/8	35	4 13/16	122	1 13/16	45	24.2	686	3/8	10	2 1/4	56	1800	816	3600	1633	3:1 / 4:1
E3250.HL	High-load/double sheave/deadend (pair)	1 9/16	40	4 13/16	122	1 13/16	45	27.8	788	3/8	10	2 1/2	64	2500	1134	5000	2268	3:1 / 4:1
E3256	Double sheave/deadend/150 Cam-Matic (pair)‡	1 3/8	35	3 3/4	95	4 1/8	104	45.08	1278	3/8	10	2 1/4	56	900	408	2300	1040	4:1

*Requires high-beam track. **Weight each. ***Includes 10 mm RH fasteners.

118 ‡Maximum working loads and breaking loads based on cam strengths.

32 mm Big Boat: Car Accessories



Traveler kit installation



Stand-Up Toggles

Stand-up toggles hold blocks upright on travelers. Control tangs allow attachment of ball bearing Carbo control blocks.

Refer to chart below for mainsheet block compatibility. See page 120 for control block purchase selection guide.

Couplers

Big Boat couplers join two cars to form high-load assemblies. The high-load 580 and 752 couplers fit T3201B and T3201B.HL cars. Use 580 and 752 couplers for single-point attachments. Use single, double, or triple Black Magic with the 752 coupler.

Control Block Kits

Kits are available for Big Boat cars to add ESP sleeve-bearing control systems for up to 6:1 purchases. Combine with ESP end controls.

Replacement Traveler Kit

Replacement traveler kits are the easiest way to restore modern traveler function. Kit comes with prematched parts for easy retrofits.



3225



1947



3190



1948



1949



Control blocks attach to ears to reduce load on car.



Toggles have a low pivot point to handle mainsheet loads up to 40 degrees from vertical, while allowing cars to roll freely.



752



580



T32KIT
T32KIT.HL

Replacement Traveler Kit

Part No.	Description	Boat length				Max mainsail area				Maximum working load		Purchase	Includes
		Mid-boom		End-boom		Mid-boom		End-boom		lb	kg		
		ft	m	ft	m	ft ²	m ²	ft ²	m ²				
3190	32 mm traveler kit/4:1	31 - 40	9.5 - 12.2	35 - 44	10.7 - 13.4	350	32.5	425	39.5	3000	1361	4:1	(1) T3241B, (1 pair) E3256

Stand-Up Toggles

Part No.	Description	Mainsheet block pin Ø		Control block pin Ø		Height		Maximum working load		Accepts mainsheet blocks
		in	mm	in	mm	in	mm	lb	kg	
1947	Stand-up toggle	5/16, 3/8	8, 10			2 15/32	63	7500	3401	60 mm Element doubles, triples; 80 mm Element singles; Midrange blocks; 57 mm double, triple Black Magic; 75 mm single, double Black Magic;
1948	Stand-up toggle/control tangs	5/16, 3/8	8, 10	1/4	6	2 3/4	70	7500	3401	100 mm single Black Magic
1949	Stand-up toggle/1 control tang	5/16, 3/8	8, 10	1/4	6	2 3/4	70	7500	3401	

Couplers & Control Block Kits

Part No.	Description	Sheave Ø		Length		Width		Weight		Max line Ø		Maximum working load		Breaking load	
		in	mm	in	mm	in	mm	oz	g	in	mm	lb	kg	lb	kg
580	Coupler			7 1/4	184	1 1/2	38	21	595			6000	2722	12000	5443
752	Coupler			10 3/4	273	1 1/2	38	28	794			9000	4082	18000	8165
3225	2-sheave control block*	2 1/4	57	5 3/8	143			8.8	249	1/2	12	2500	1134	5000	2268
T32KIT	Purchase upgrade kit	(4) 35 mm control blocks, (2) Midrange/Big Boat deadends, (8) M6 fasteners													
T32KIT.HL	Purchase upgrade kit/high-load	(4) 40 mm control blocks, (2) Big Boat deadends, (8) M8 fasteners													

*Fits T32x4B.HL cars.

32 mm Big Boat: Purchase Selection Guide



T55, 15.24 m (50'), Marsaudon Composites, naval architect: Christophe Barreau © Gérald Bibot

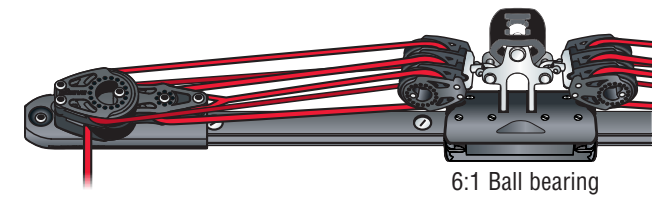
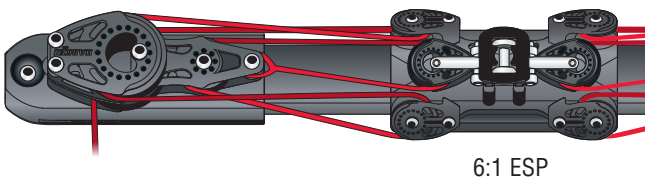
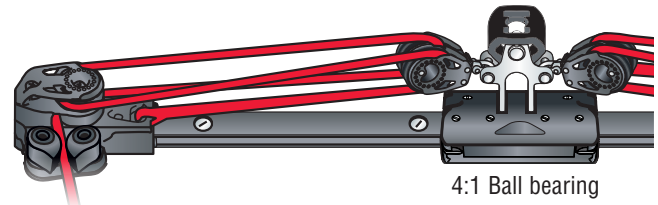
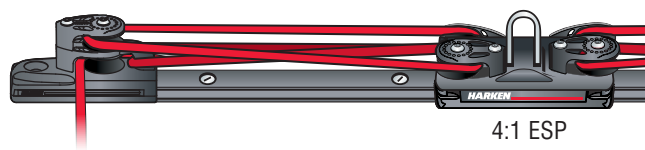
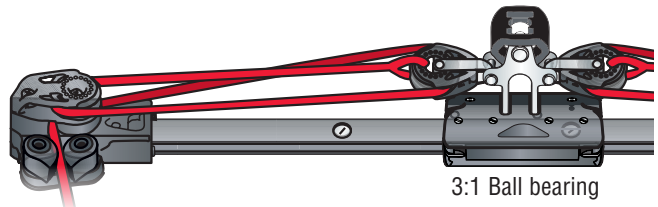
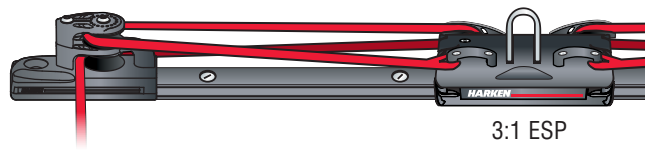
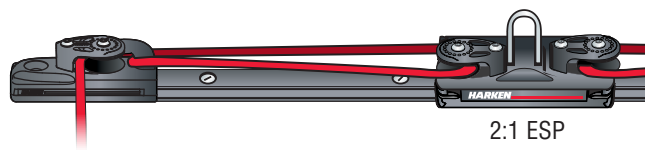

Purchase	Car	End control	Control block on car
2:1 ball bearing	T3203B	3168	1948 with 2600
2:1 ESP	T3201B	E3230	T32KIT
3:1 ball bearing	T3203B	3169, 3170	1948 with 2601
3:1 ESP	T3201B	E3250, E3256	T32KIT
4:1 ball bearing	T3203B	3169, 3170	1948 with 2642
4:1 ESP	T3201B	E3250, E3256	T32KIT
6:1 ball bearing	T3201B	3197	1948 with 2640
6:1 ESP	T3201B	3197	T32KIT & 1948 with 2650



32 mm Big Boat: Genoa Lead Cars

CB adjustable genoa lead cars feature recirculating Torton® ball bearings for easy adjustment under full sheet loads.

Stainless steel sheave carriers pivot 60 degrees to accommodate changing lead angles. Wide sheave holds two sheets during sail changes.

Cars feature car-mounted, sleeve-bearing control blocks for strength and durability. All CB genoa lead cars are compatible with Harken end controls. Kits are available for purchase upgrades up to 4:1.

CB Adjustable Cars

Sheave carriers feature high-performance sheaves with roller bearings to handle radial loads, while sideload balls handle thrust loads for easy trimming and fore-and-aft adjustment.

ESP CB Adjustable & Pinstop Cars

Sheave carriers feature ESP sleeve bearing sheaves.

Use pinstop cars in applications where lead positions change infrequently.

Pinstop and ball bearing genoa lead cars both run on ball bearing track, allowing system upgrades without changing track.

Torton is a registered trademark of Solvay Advanced Polymers L.L.C.



CB ADJUSTABLE



ESP CB ADJUSTABLE



PINSTOP



CUSTOM

For sheet-loading formulas see page 279.

End control selection guide

Purchase	Car	End control
2:1	HC4928	E3230.HL
3:1	G323B/G3237B	E3250.HL/3174
4:1	G324B/G3247B	E3250.HL/3174

Part No.	Description	Sheave Ø		Length		Width		Weight		Maximum working load		Breaking load		Track
		in	mm	in	mm	in	mm	oz	g	lb	kg	lb	kg	
CB Adjustable														
G3237B	Big Boat/sheave/deadend	3	76	9 1/16	231	3 3/8	85	63.27	1794	5000	2268	10000	4536	R32
G3247B*	Big Boat/2 sheave	3	76	9 1/16	231	3 3/8	85	65.12	1846	5000	2268	10000	4536	R32
ESP CB Adjustable														
G323B	Big Boat/sheave/deadend	3	76	9 1/16	231	3 3/8	85	59.54	1688	5000	2268	10000	4536	R32
G324B	Big Boat/2 sheaves	3	76	9 1/16	231	3 3/8	85	62.14	1761	5000	2268	10000	4536	R32
G322B.HL	Big Boat/sheave	3	76	10 5/8	270	3 3/8	85	85.43	2422	7716	3500	15432	7000	R32
ESP Pinstop														
G326S	Big Boat/pinstop	3	76	9 1/8	232	2 1/2	64	53.26	1510	5000	2268	10000	4536	R32
G326S.HL	Big Boat HL/pinstop	3	76	9 1/8	232	2 1/2	64	62	1758	6000	2722	12000	5443	R32
Custom														
C6795	Big Boat/pinstop‡	3	76	10	254	2 1/4	57	61.83	1753	7716	3500	15432	7000	R32
C9815	Big Boat genoa lead** ‡	2 15/16	75	10	254	2 3/8	60	56.44	1600	13228	6000	26448	12000	R32**
C10232	Big Boat/pinstop** ‡	2 15/16	75	10	254	2 3/8	60	61	1738	13228	6000	26448	12000	R32**

*Available as a non-CB car on a car loader to run on a non-CB style track supplied before 2004. Add .NW to end of part number. See page 276 for replacement balls.

**50 mm hole spacing required. ‡Contact Harken to request quote and lead time.

CB Cars: Windward Sheeting & 3:1 Cars with Cams

Windward Sheeting Cars

Race once with the windward sheeting traveler car and you'll never race without one again. Pull the car above the centerline without releasing the leeward control line. Tack, and the car stays in the same position, ready to be pulled to the new windward side.

Mount track in the cockpit or near deck level.
For dinghies to large offshore boats.

3:1 Midrange Cars with Cams

The 1628 and 1629 cars with 365 Carbo-Cam cleats provide additional mechanical advantage (3:1 versus 2:1) by trimming from the car as opposed to a fixed point at the end of the track. Cars fit 27 mm Midrange CB track.



2745



2746



1635
1636



3176
3178



3177
3179

WINDWARD SHEETING CARS



Patented wire retaining clips keep balls captive, making cars easy to load and maintain. Composite corner keepers help keep ball bearings captive when the car is off the track. For a cost-effective option, CB+ cars can be modified to run on Harken non-CB track.



1628
1629

3:1 MIDRANGE
CARS WITH CAMS*



2752

1637

3180

WINDWARD SHEETING ADAPTER KITS

Windward Sheeting Adapter Kits

Part No.	Description	Max line Ø		Fits cars	Purchase
		in	mm		
1637	Midrange CB	3/8	10	1624 / 1625	3:1 / 4:1
2752	Small Boat CB	5/16	8	2726 / 2727 / 2728	2:1 / 3:1 2729 / 2730 / 2731 / 2735 / 2736 / 2753 / 2754
3180	Big Boat CB	3/8	10	3163 / 3165	4:1 / 5:1 / 6:1

Part No.	Description	Length		Width		Weight		Max line Ø		Maximum working load		Breaking load		Purchase/end controls
		in	mm	in	mm	oz	g	in	mm	lb	kg	lb	kg	
22 mm Small Boat Windward Sheeting														
2745	Small Boat CB	6 7/8	175	3 1/16	78	24.75	702	5/16	8	850	386	2500	1134	2:1 / 3:1 / 2740
2746	Small Boat CB/high-load	6 7/8	175	3 1/16	78	26	737	5/16	8	1250	567	2500	1134	2:1 / 3:1 / 2740
27 mm Midrange 3:1 Cars with Cams														
1628	Midrange CB/365 Carbo-Cam*	9 1/8	232	4 3/8	111	25.76	730	3/8	10	1800	816	5000	2268	3:1 / 1631
1629	Midrange CB/high-load/365 Carbo-Cam*	9 1/8	232	4 3/8	111	27.2	771	3/8	10	2300	1043	5000	2268	3:1 / 1631
27 mm Midrange Windward Sheeting														
1635	Midrange CB	6 3/4	171	4 1/8	105	35	990	3/8	10	1800	816	5000	2268	3:1 / 4:1 / 1631
1636	Midrange CB/high-load	6 3/4	171	4 1/8	105	36	1020	3/8	10	2300	1043	5000	2268	3:1 / 4:1 / 1631
32 mm Big Boat Windward Sheeting														
3176	Big Boat CB	9 9/16	243	5	127	57	1618	3/8	10	3000	1361	7000	3175	4:1 / 3168, 5:1 / 6:1 / 3169
3177	Big Boat CB/stand-up	9 9/16	243	5	127	62	1747	3/8	10	3000	1361	7000	3175	4:1 / 3168, 5:1 / 6:1 / 3169
3178	Big Boat CB/high-load	9 9/16	243	5	127	61	1723	3/8	10	4500	2041	9000	4081	4:1 / 3168, 5:1 / 6:1 / 3169
3179	Big Boat CB/high-load/stand-up	9 9/16	243	5	127	65	1851	3/8	10	4500	2041	9000	4081	4:1 / 3168, 5:1 / 6:1 / 3169

See page 275 for replacement balls. *Not windward sheeting. Stop knot required to keep car from hitting end control.

CRX Roller Cars

The Harken Custom Division has been supplying racers and cruisers with innovative hardware for over 20 years. Whether you use existing custom solutions or require something new, our engineers hold your project to the highest standards: from design, to manufacturing, finishing, installation, and worldwide service.

CRX Cars

CRX Roller traveler cars carry almost double the load at half the weight of similarly sized traveler cars. Torlon® rollers provide increased bearing contact over balls to handle higher loads. Captive bearings make cars easy to load and maintain.

Toggle cars such as the 3074 and 3075 offer a low-profile traveler solution. CRX Loop cars are alternatives for high-load applications.

Use roller travelers with straight track only. Contact Harken for curved traveler applications. Big Boat CRX track uses E3200 endstops and 3173 or 3174 end controls. Mini-Maxi track uses 1702 or custom endstops.

PCRX System

The award-winning PCRX mainsheet traveler features a hinged track that pivots as the mainsheet angle changes. This design aligns the car to the load for less friction, more load capacity, and lighter weight. Eliminating the toggle reduces the car's height and weight. Mini-Maxi PCRX traveler systems are used on America's Cup and Volvo racers, with Big Boat versions on TP52s and IRC 70s.

Torlon is a registered trademark of Solvay Advanced Polymers L.L.C.



Rollers carry extreme loads in a compact, lightweight package.

Captive rollers for easy loading and maintenance.



3074



3075



C8728
C9460

32 MM BIG BOAT



C10747



C8862
C9701



C8955
C9642



C9563

42 MM MINI-MAXI

CRX Roller Cars

Quantum Racing, Keith Brash photo © Quantum Racing



C8990

C6924



Blocks not included

PCRX systems have carbon bobbins laminated into the deck, eliminating track fasteners to reduce weight.



Low-profile endstops available for PCRX and CRX roller systems. Contact Harken.

MEGA

Part No.	Description	Length		Width		Height		Weight		Maximum working load		Breaking load		Track
		in	mm	in	mm	in	mm	oz	g	lb	kg	lb	kg	
32 mm Big Boat CRX														
3074	CRX Big Boat/single block	5	127	2 1/2	64	3 3/8	86	22	624	5000	2268	10000	4535	3079
3075	CRX Big Boat/single block‡	7 1/2	191	2 1/2	64	3 3/8	86	39	1106	7500	3401	15000	6803	3079
C8728	CRX Big Boat Loop car	3 3/8	86	2 1/2	64	2	51	11.6	330	3300	1497	6600	2994	3079
C9460	CRX Big Boat Loop car	7 1/2	191	2 1/2	64	2	51	25.42	721	7483	3400	14967	6800	3079
42 mm Mini-Maxi CRX														
C8862	CRX Mini-Maxi/titanium coupler/2 blocks/fix track	15 1/2	394	3 1/32	77	4 11/16	119	97.32	2759	15000	6803	30000	13608	3200
C8955	CRX Mini-Maxi Loop car	7 1/2	191	3 1/32	77	2 1/4	57	29.2	827	7937	3600	15874	7200	3200
C9563	CRX Mini-Maxi/2 blocks	12	305	3 1/32	77	10 3/4	274	233.58	6622	15000	6803	30000	13608	3200
C9701	CRX Mini-Maxi/titanium coupler/2 blocks	16 3/16	411	3 1/32	77	4 11/16	119	113.63	3222	19845	9000	39618	18000	3200
C9642	CRX Mini-Maxi Loop car	8	203	3 1/32	77	2 5/8	67	34.39	975	9921	4500	19845	9000	3200
C10413	CRX Mini-Maxi Loop car	11 1/2	292	3 7/32	82	3	76	57.97	1643	14434	6558	28868	13116	3200
C10747	CRX Mini-Maxi/aluminum coupler/2 blocks	15 1/8	384	3 1/32	77	5 9/16	141	96.06	2723	14307	6500	28613	13000	3200
Mega CRX														
C6924	CRX mega/coupled	16 1/4	413	4 1/4	108	6 1/2	165	263.04	7457	26500	12020	53000	24040	Custom
C8990	CRX mega/coupled	20 1/4	515	4 1/4	108	6 1/2	165	301.59	8550	33069	15000	66138	30000	Custom

Contact Harken to request quote and lead time. ‡Includes adapter to fit 100 mm Black Magic.

CRX Track

Part No.	Length		Mounting hole spacing		Weight		Fasteners (FH)		Endstop/splice link
	ft/in	m	in	mm	oz	kg	in	mm	
32 mm Big Boat CRX Low-Beam Roller Track									
3079.2M	6' 6 3/4"	2	2 15/16	75	72.8	2.064	5/16	8	E3200/3080
3079.3M	9' 10 1/16"	3	2 15/16	75	109.2	3.096	5/16	8	E3200/3080
42 mm Mini-Maxi CRX Low-Beam Roller Track									
3200.3M*	9' 10 1/16"	3	2 15/16	75	144.1	4.08		10	

*Contact Harken for track profile.

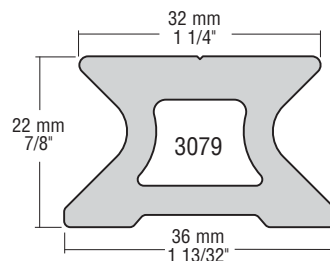

42 mm Mini-Maxi

Mainsail Traveler Cars

42 mm Mini-Maxi travelers bring the ease of dinghy traveler adjustment to large offshore boats. Cars ride on two rows of recirculating Torlon® ball bearings and roll freely under high, nonvertical loads. Custom configurations or cars for horizontally curved track available on request.

Genoa Lead Cars

All cars are available with a plain body, with pinstops, or puller tangs. Car bodies are made of either hardcoat-anodized aluminum or high-luster stainless steel. Maximum working loads range from 4082 kg (9000 lb) to 9000 kg (19842 lb). Custom cars can be designed to handle higher loads.

Torlon is a registered trademark of Solvay Advanced Polymers L.L.C.



ENDSTOPS



GENOA LEAD CARS



MAINSAIL TRAVELER CARS

Mainsail Travelers

Part No.	Description	Length		Width		Height		Weight		Maximum working load		Breaking load		Track
		in	mm	in	mm	in	mm	oz	g	lb	kg	lb	kg	
1702	Endstop*	3 3/4	95	2 5/8	67	1 1/2	38	13	369					1706
1708	Adjustable stop	3 1/2	89	2 5/8	67	2 1/16	52	15	425					1706
1707	End control/padeye	5 1/4	133	2 5/8	67	3 1/8	79	29	822	7800	3540	15594	7075	1706
3069	End control/footblock/becket	5 5/8	143	2 5/8	67	2 3/4	70	25	710	2500	1134	5000	2268	1706
C7513	Endstop/627 padeye‡	3 13/16	97	2 5/8	67	2 11/16	68	19	528	4300	1950	8600	3900	1706
C10075	Endstop/648 padeye‡	3 7/8	98	3 13/16	97	3 1/8	79	32	896	7500	3402	15000	6804	1706
HC10066	Traveler/HCP1128 toggle	10	254	4 3/8	111	4 3/16	106	91	2574	8750	3969	18000	8164	1706
3068	Traveler**	10	254	4 3/8	111	3 3/4	95	81	2300	8750	3969	18000	8164	1706
C5280	Traveler/(2) 3261 blocks‡	16	406	4 3/8	111	11	278	221	6275	12500	5670	25000	11340	1706
C5231	Traveler/(2) 3254 blocks‡	16	406	4 3/8	111	10	243	192	5443	10600	4808	21200	9616	1706
C7152	Self-tacking car‡	16 1/4	412	4 5/16	110	2	51	129	3644	11736	5325	27998	12700	1706

*12 mm (1/2") FH fasteners. **See page 276 for replacement balls. ‡Contact Harken to request quote and lead time.

Genoa Lead Cars

Part No.	Description	Sheave Ø		Length		Width		Height		Weight		Maximum working load		Breaking load		Track
		in	mm	in	mm	in	mm	in	mm	oz	g	lb	kg	lb	kg	
C5900	Mini-Maxi lead car/slider rods	5 1/2	140	12	305	2 15/16	75	9 3/16	233	208.11	5900	14994	6800	39242	17800	1706
C10741	Mini-Maxi lead car/puller	5 29/32	150	14	356	2 15/16	75	10 11/16	271	225	6392	19845	9000	39690	18000	1706
C10720	Mini-Maxi stainless steel lead car/puller	5 29/32	150	14	356	2 15/16	75	10 11/16	271	402	11407	19845	9000	39690	18000	1706

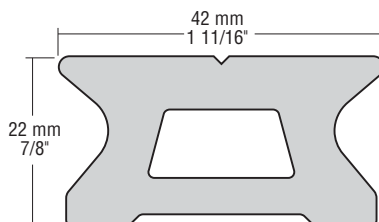

Track

Part No.	Length	Mounting hole spacing*		Weight		Fasteners (FH)			
		ft/in	m	in	mm	oz	kg	in	mm
1706.1.5M	4' 11 11/16"	1.5	2 15/16	75	81.5	2.31	3/8	10	1702
1706.3M	9' 10 1/8"	3	2 15/16	75	163	4.62	3/8	10	1702
1706.3.6M	11' 9 3/4"	3.6	2 15/16	75	195.4	5.54	3/8	10	1702
1706.6M	19' 8 1/4"	6	2 15/16	75	325.9	9.24	3/8	10	1702

*First hole 37.5 mm (1 1/2").

Track bending				
Minimum track radius				
Horizontal		Vertical		
Track	ft	m	ft	m
1706	50	15.25	50	15.25

64 mm Maxi

Mainsail Traveler Cars

64 mm Maxi travelers bring the ease of dinghy traveler adjustment to large offshore boats. Cars ride on two rows of recirculating Torton® ball bearings and roll freely under high, nonvertical loads. Custom configurations or cars for horizontally curved track available on request.

Genoa Lead Cars

All cars are available with a plain body, with pinstops, or puller tangs. Car bodies are made of either Hard Lube-anodized aluminum or high-luster stainless steel. Maximum working loads range from 9000 kg (19841 lb) to 13000 kg (28660 lb). Custom cars can be designed to handle higher loads.

Torton is a registered trademark of Solvay Advanced Polymers L.L.C.



ENDSTOPS



GENOA LEAD CARS



MAINSAIL TRAVELER CARS

Mainsail Travelers

Part No.	Description	Sheave Ø		Length		Width		Height		Weight		Maximum working load		Breaking load		Track	
		in	mm	in	mm	in	mm	in	mm	oz	g	lb	kg	lb	kg		
C5160	Double pinstop**			5 1/4	133	3 3/4	95	2 9/16	65	38	1077	1900	8618	38000	17232	Custom	
C6361	Endstop w/689 padeye**			4 11/16	119	3 3/4	95	3 1/2	89	37	1048	7800	3540	15600	7075	661	
662	Endstop*			4 3/4	121	3 3/4	95	2	51	28.8	816					661	
664	Adjustable stop			3 7/8	98	3 3/4	95	2 1/2	64	26	737					661	
3071	End control/footblock/becket	2 15/16	75	7 1/8	181	3 3/4	95	3 3/8	86	56	1596	5250	2380	10500	4762	661	
C10937	Traveler w/(2) HC8674 MYB**‡		5	125	27	686	5 3/16	132	11 5/8	295	559.5	15862	21168	9600	42336	19200	661
C8441	Traveler**‡	5 15/16	150	27	686	5 3/16	132	12 7/8	327	527.2	14946	21168	9600	42336	19200	661	
C8583	Traveler**‡	5 15/16	150	28 1/4	718	5 3/16	132	12 7/8	327	537.6	15241	21168	9600	42336	19200	661	

*16 mm (5/8") FH fasteners. ‡When used in 4:1 system MWL is 13608 kg/30000 lb. **Contact Harken to request quote and lead time.

Genoa Lead Cars

Part No.	Description	Sheave Ø		Length		Width		Height		Weight		Maximum working load		Breaking load		Track
		in	mm	in	mm	in	mm	in	mm	oz	g	lb	kg	lb	kg	
C9543	Genoa lead/forward pull	6 7/8	175	14	356	3 11/16	93	12 11/16	322	293.8	7462	28660	13000	57330	26000	661
C9368	Slider/dual pinstop	5 15/16	150	12	305	3 9/16	91	12 1/4	311	205.6	5829	19841	9000	39683	18000	Custom

Contact Harken to request quote and lead time.

Track bending				
Minimum track radius				
Track	Horizontal		Vertical	
	ft	m	ft	m
661	100	30.5	50	15.25

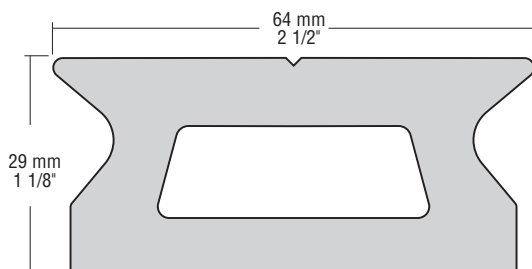

Track

Part No.	Length		Mounting hole spacing*		Weight		Fasteners (FH)		
	ft/in	m	in	mm	oz	kg	in	mm	Endstop
661.2.1M	6' 10 11/16"	2.1	3 15/16	100	221.5	6.28	1/2	12	662
661.3M	9' 10 1/8"	3	3 15/16	100	316.4	8.97	1/2	12	662
661.6M	19' 8 1/4"	6	3 15/16	100	632.8	17.94	1/2	12	662

*First hole 50 mm (1 15/16").

Curved Track

Track is often bent to follow the cabin house curve or boom radius. Sometimes track is bent vertically, ends up, to relieve tension on the sail's leech as the traveler car moves off the boat's centerline.

To perform smoothly and carry the correct load, the traveler car's length must suit the track radius. Each traveler car page has a chart which shows the minimum radius on which each car will ride. If the load requires a long car, but the radius will be too tight, consider using two short cars joined by a coupler.

Minor bends can often be made when the track is installed. If the track requires more bend, Harken can provide horizontal, vertical, or compound curves to specification for a modest charge. If the bend is continuous, add 50 - 100 mm (2 - 4") to each end because track cannot be bent to its ends. Standard Harken Mini-Maxi and Maxi traveler cars cannot ride on vertical bends with a radius under 15.25 m (50').

1. Vertical Bend: Ends Down

This bend is used for mainsheet travelers mounted over the cabin house. The curve matches the crown of the cabin house and allows the track to clear the companionway hatch, but minimizes the height of the track risers.

2. Vertical Bend: Ends Up

Some boats use this bend to relieve leech tension when the traveler car moves off centerline. Ends-up bends are also used for staysails. Tracks angled forward to face the clew of the sail mount on risers.

3. Horizontal Bend

Horizontal bends allow the traveler to follow the radius of the boom as it swings across the boat. The track stays flat and the ends curve to the boat's bow or stern. Sometimes horizontal bends are used for boom vang and occasionally for staysails, especially those with booms.

4. Compound Bend

Compound bends are a combination of a vertical and horizontal bend. The track curves in the horizontal plane to follow the radius of the boom, but mounts to a deck that has a slight crown.



Track	Compound bends			
	Simple bend Part No.	Major bend Part No.	Simple Part No.	Major Part No.
2707	485*	486*	—	—
2709	487	488	—	—
373/374/2720/2721/2725/2751	274	275	276	286
1602/R27	1527	1528	1529	1581
R27HB	1530	1531	1532	1582
R32/3159	789	790	791	576
R32HB/1706	792	793	794	577
661	795	795	795	795

Simple bend: track length of 2 m (6'6³/₄") or less **and** chord depth less than 200 mm (8").
Major bend: track length of 2.1 m (6'10¹/₁₆") or greater **or** chord depth of 200 mm (8") or greater.
Compound bend: bend in both horizontal and vertical planes.
Compound simple bend: both bends are simple bends.
Compound major bend: one or both bends are major bends.

*Horizontal only. Contact Harken Tech Service for vertical bends.

Ordering Information

To order curved traveler track, please specify the following information:

Boat model _____

Track part number _____

Bend part number _____

Chord length _____

Chord depth: horizontal _____ or radius: horizontal _____

Chord depth: vertical _____ or radius: vertical _____

Check one:

Vertical bend: ends down

Vertical bend: ends up

Horizontal bend: ends forward or aft

Compound bend:
horizontal and vertical (ends down)

Compound bend:
Horizontal and vertical (ends up)

Aluminum & Stainless Steel T-Track

Anodized aluminum T-Track features rounded top edges for protection and impact resistance. Drilled and tapped holes at ends make endstop installation easy.

32 mm high-performance track is black hardcoat-anodized. It has precise 33 mm pinstop hole spacing.

Stainless steel track is available in 32 and 40 mm. The high-luster finish makes it ideal for luxury cruisers/racers from 9.5 m - 42 m (33 - 140').



zefira, 49.7 m (163'), Dubois Naval Architects, © Fitzroy Yachts Ltd, www.fitzroyyachts.com

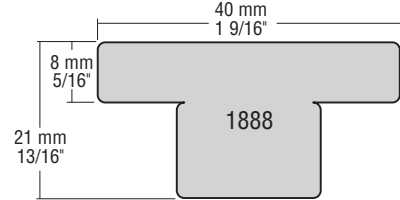
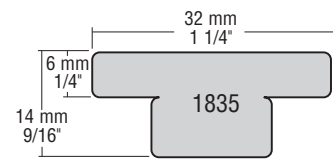
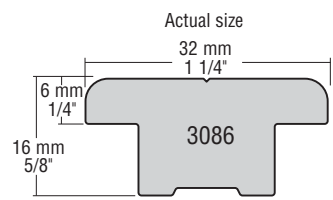

Part No.	Length		Pinstop hole spacing		Mounting hole spacing*		Weight		Fasteners (FH)		Endstop
	ft/in	m	in	mm	in	mm	oz	kg	in	mm	
32 mm Black-Anodized Aluminum T-Track											
3086.2M	6' 6 3/4"	2	3 15/16	100	3 15/16	100	63.46	1.8	5/16	8	
3086.3M	9' 10 1/8"	3	3 15/16	100	3 15/16	100	95.22	2.69	5/16	8	
32 mm Stainless Steel T-Track**											
1835.2M	6' 6 3/4"	2	1 15/16	50	3 15/16	100	169.31	4.8	5/16	8	1836
1835.4M	13' 1 1/2"	4	1 15/16	50	3 15/16	100	338.62	9.6	5/16	8	1836
40 mm Stainless Steel T-Track**											
1888.2M	6' 6 3/4"	2	1 15/16	50	3 15/16	100	282.91	8		12	1889
1888.4M	13' 1 1/2"	4	1 15/16	50	3 15/16	100	564.37	16		12	1889

50 mm T-Track available. Contact Harken to request quote and lead time. *First hole 50 mm (1 15/16").

128 **Contact Harken to request lead time.

T-Track Genoa Lead Cars

T-Track genoa lead cars are used where frequent lead adjustments are not required. T-Track cars have an integral pinstop to lock the car into position.

The car's one-piece, solid aluminum construction is lightweight and strong. The stainless steel carrier tilts side-to-side to ensure a fair lead. 40 mm cars have roller/ball bearing sheaves to improve trimming performance.

Custom accessories such as remote pinstops and adjustable sliders with tangs to accommodate floating blocks are available. Contact Harken for information on our complete range.

Note: T-Track genoa lead cars cannot be adjusted under load.



GT326S



C9242



C10913



C10901

Skimmer, Balance 760 F, 22 m (78.12'), Du Toit Yacht Design
© Grant Scholtz / Two Oceans Marine Manufacturing



C4219
C7788



C5754



C7754

For sheet-loading formulas see page 279.

Part No.	Description	Sheave Ø		Length		Width		Height		Weight		Max line Ø		Maximum working load		Breaking load		Track
		in	mm	in	mm	in	mm	in	mm	oz	g	in	mm	lb	kg	lb	kg	
32 mm T-Track																		
GT326S	Genoa lead car/pinstop*	2	51	5 1/8	130	2	51	4 7/16	113	22.1	626	1/2	12	3000	1361	6000	2722	3086
40 mm T-Track																		
C4219	Genoa slider**‡	4 1/2	114	9	229	2 9/16	65	8 7/16	214	104.6	2970	5/8	16	12860	5845	25720	11690	1888
C7788	Genoa lead car‡	4 1/2	114	9	229	2 9/16	65	8 7/16	214	104.6	2970	5/8	16	8500	3856	17000	7712	Custom
C5754	Jib car/maxi sheave**‡	5 1/2	140	11	279	2 9/16	65	9 1/4	235	184	5220	7/8	22	19625	8900	39249	17800	1888
C7754	Jib car/maxi sheave/bail**‡	5 1/2	140	11	279	2 9/16	65	9 1/4	235	188	5318	7/8	22	19625	8900	39249	17800	1888
C9577	Jib car/pinstop**‡	5 15/16	150	11	279	2 9/16	65	10 3/4	273	312	8824	1	25	15435	7000	44092	20000	1888
50 mm T-Track ‡‡																		
C9242	T-Track slider/puller tang‡	7 7/8	200	14	356	3 3/8	86	13 5/8	346	649	18400	1 1/8	28	50706	23000	101412	46000	Custom
C10901	T-Track slider/puller tang*	7 7/8	200	14	356	3 3/8	86	14	356	418	11837	1 1/8	28	50706	23000	101412	46000	Custom
C10913	T-Track slider/puller tang*‡	7 7/8	200	14	356	3 3/8	86	13 5/8	346	659.6	18700	1 1/8	28	50706	23000	101412	46000	Custom

*Aluminum. **Stainless steel track only. ‡Contact Harken to request quote and lead time. ‡‡50 mm T-Track available. Contact Harken.

Access Rail System

Harken designed the Access Rail system so crews of very large yachts would have a secure system that allows freedom of movement, and the ability to lock into position while working outboard along the hull. The Access Rail system is made up of two joined cars that allow the attachment of the personal suspension and the required fall-arrest systems. Its CE certification is among the most respected marks in the world and unique in the marine industry.

Linked cars are constructed of strong, lightweight, one-piece solid aluminum. The pinstop is easy to release, and the car moves smoothly along the track before locking into another position. Patented wire retaining clips keep balls captive, making cars easy to load and maintain. Composite corner keepers help keep ball bearings captive when the car is off the track.

Cars and track come in black hardcoat-anodized or clear-anodized finishes for corrosion protection, durability, and to match the yacht's aesthetics. Stainless steel systems can be special ordered from Harken's Custom Division.

Use the IN10567 car when the track is mounted on a brow or angled on surfaces. The wheel toggle attachment overhangs the edge of the mounting surface so the side of the hull is not chafed.



IN9606.CLEAR

IN10567.CLEAR



IN1643.CLR

IN1650.CLR



IN9561.CLEAR



IN1642.CLEAR



IN1649
IN1651



Pinstop car allows movement of cars along track. Open to move; close to lock in place.

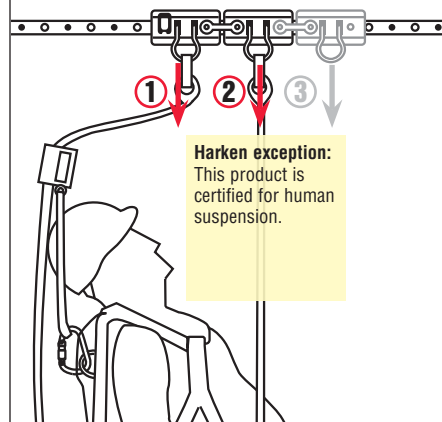

The system has two anchorage points—one anchorage point for a personal suspension system and the second for the fall-arrest system. Add an optional car and coupler to work as a tool service carrier.

Harken exception: This product is certified for human suspension.

Access Rail System



Patented wire retaining clips keep balls captive, making cars easy to load and maintain. Composite corner keepers help keep ball bearings captive when the car is off the track. For a cost-effective option, CB+ cars can be modified to run on Harken non-CB track.



Photo © TLC Refit & Repairs



M/Y Princess Too photo



Car Assembly

Part No.	Description	Length		Width		Maximum working load		Fits track
		in	mm	in	mm	lb	kg	
IN9606.CLEAR*	27 mm Midrange 2-car Access Rail car assembly with coupler	10 3/4	273	2 3/4	70	300	136	IN1643, IN1650
IN10567.CLEAR*	27 mm Midrange 2-car Access Rail car assembly with wheel toggle	10 3/4	273	5 15/16	150	300	136	IN1643, IN1650

Access Rail cars must only be used with track mounted using 8 mm (5/16") fasteners. Use only endstops listed below.

*To order black hardcoat-anodized, remove ".CLEAR" from end of part number.

Removable Pinstop & Track Endstop

Part No.	Description	Length		Width		Weight		Height above track		Fasteners	
		in	mm	in	mm	oz	g	in	mm	in	mm
IN1642.CLEAR*	Pinstop	2 5/16	59	1 15/16	49	4.8	136	1 5/16	33		
IN9561.CLEAR*	27 mm Midrange track endstops (sold in pairs)	2 1/4	57	2	51	6	170	5/16	8	5/16 FH	8 FH

*To order black hardcoat-anodized, remove ".CLEAR" from end of part number.

Track

Part No.	Description	Length		Mounting hole spacing		Fasteners		Endstop	Splice link**
		ft/in	m	in	mm	in	mm		
IN1643.3M.CLR*	27 mm Midrange pinstop track for countersink fasteners	9' 10 1/16"	3	3 15/16	100	5/16 FH	8 FH	IN9561.CLEAR*	IN1649
IN1643.3.6M.CLR*	27 mm Midrange pinstop track for countersink fasteners	11' 9 3/4"	3.6	3 15/16	100	5/16 FH	8 FH	IN9561.CLEAR*	IN1649
IN1643.6M.CLR*	27 mm Midrange pinstop track for countersink fasteners	19' 8 1/4"	6	3 15/16	100	5/16 FH	8 FH	IN9561.CLEAR*	IN1649
IN1650.3M.CLR*	27 mm pinstop track for caphead fasteners	9' 10 1/16"	3	3 15/16	100	5/16 SHCS	8 SHCS	IN9561.CLEAR*	IN1651
IN1650.3.6M.CLR*	27 mm pinstop track for caphead fasteners	11' 9 3/4"	3.6	3 15/16	100	5/16 SHCS	8 SHCS	IN9561.CLEAR*	IN1651

*To order black hardcoat-anodized, remove ".CLR" or ".CLEAR" from end of part number. **Purchase one splice link for each track section.

Harken exception: This product is certified for human suspension.

MAINSAIL HANDLING SYSTEMS

NEW FOR 2020



Switch T-Track
Battcar Systems: 40 mm
SEE PAGES 150-152



Ordering Battcar Systems

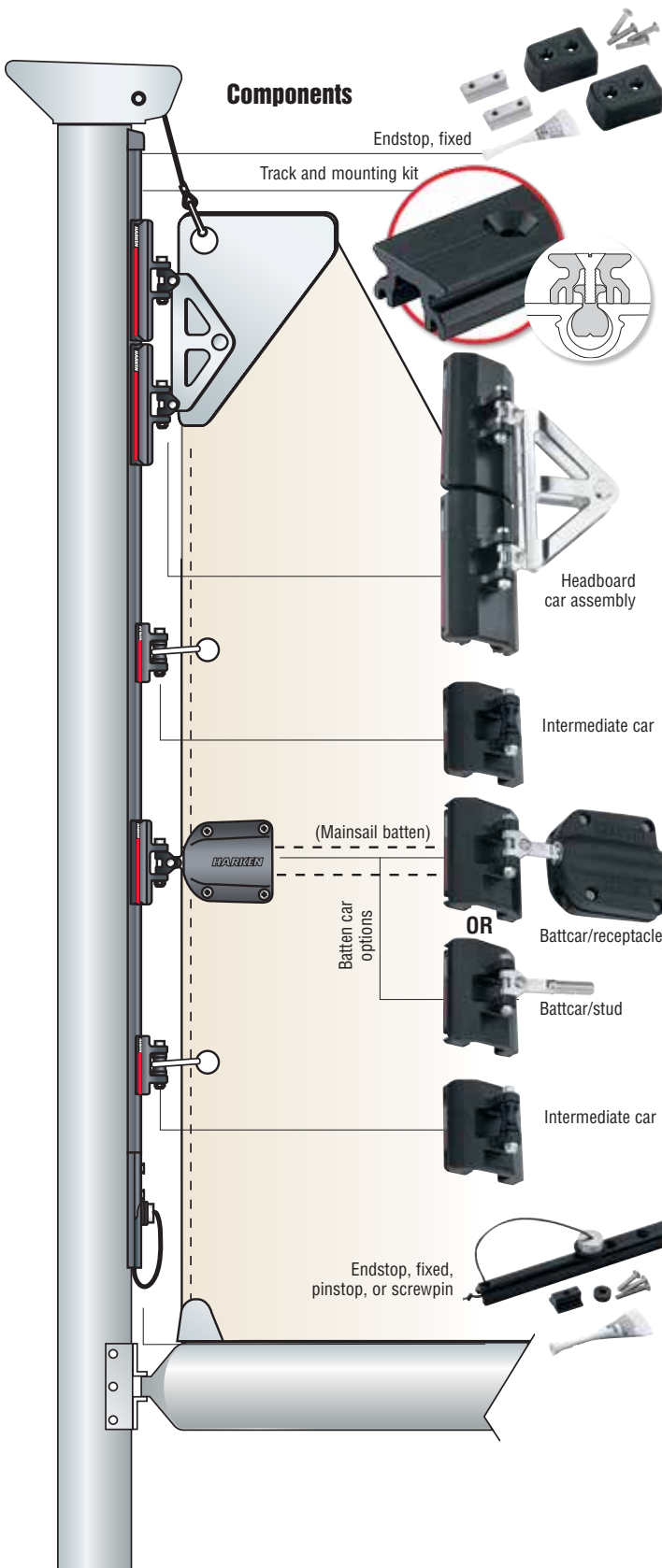

1. Determine System Size

The four sizes, systems AA, A, B, and C, are based on sail area (pages 136-143). If you need to reduce car stack height on mast, see **Switch T-Track Battcar Systems** (pages 144-151).

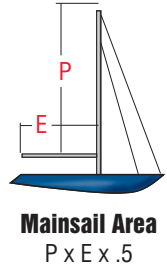

System size	Maximum sail area				Typical boat length			
	ft ²	m ²	ft ²	m ²	Monohull		Multihull	
AA	350	32	275	25	to 37	to 11.3	to 30	to 9.1
A	600	56	500	46	37 - 50	11.3 - 15.2	30 - 40	9.1 - 12.2
B	900	83	700	65	50 - 60	15.2 - 18.3	40 - 50	12.2 - 15.2
C	1940	180	1510	140	60 - 90	18.3 - 27	50 - 70	15.2 - 21

2. Determine Track Quantity and Type

Use **Mainsail Luff Length** chart on each system page to determine number of track sections.

Slug-mount: most common. Requires 1 slug-mount kit per track section. Select slug that matches the mast's boltrope groove shape.

Drill-tap: for masts without a boltrope groove. Requires 1 splice link at each track joint.

3. Choose Endstop Kit

Quick-release: includes screwpin or pinstop endstop for bottom of mast and fixed endstop for the top.

Fixed: Includes two fixed endstops.

4. Choose Cars

Order 1 headboard, 1 Battcar for every full batten, and use the **Intermediate Car Chart** to determine number of intermediate cars.

CB system: all captive ball bearing components. Lowest friction system for fast sail hoists, douses, and reefs.

Combination system: CB headboard and Battcars, Slider intermediate cars. Reduces cost but uses CB in the most critical load areas.

Slider system: all slider components. Raise and lower sails without jamming the soil in the groove.

Intermediate Cars

Distance between battens*	Distance between battens*		Intermediate cars between battens
	ft	m	
8 or less		2.4 or less	1
9 - 13		2.7 - 4	2
14 - 16		4.3 - 4.9	3

*Boats without full battens should use 1 intermediate CB or slider car per 1.2 m (4') and no Battcars.

5. Contact

If you have questions, please contact your dealer or Harken Technical Service.



CB & SLIDER BATTCAR SYSTEMS

Favored by skippers and crew, Harken Battcar systems let you raise, douse, and reef the main instantly from the cockpit, even when close reaching in a big breeze. Battcar systems outperform in-mast or in-boom furling, cost far less, and sails don't need to be recut. Four sizes fit monohulls to 27 m (90'); multihulls to 21 m (70').

Strong, corrosion-resistant cars and track stand up to sun, salt, and time

- One-piece, 6061-T6 aluminum cars Hard Lube-anodized, UV-stabilized.
- Track is 6061-T6 aluminum, hardcoat-anodized.

Low-friction ball bearing cars for easy adjustment under load

- High-strength Torlon® ball bearings circulate smoothly for fast sail hoists, douses, and reefs.
- Batten toggle moves freely in all directions to prevent sail from binding when reefing under load.

Sails can be raised/lowered without sticking in mast groove

- Slider cars ride on low-friction plastic inserts.

Materials
For properties see pages 16-17.



6061-T6 aluminum:
Hard Lube-anodized cars; hardcoat-anodized track



Torlon® thermoplastic:
Ball bearings





Quick-release button

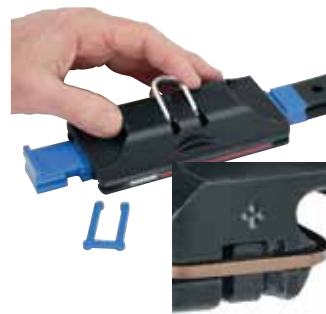

Quick sail removal

- Cars and sails slide off the track by removing the screwpin endstop—no tools required.
- Patented CB captive bearings allow cars to easily roll off track for cleaning and maintenance.
- Captive pin features a quick-release button to remove sail quickly, while allowing car to remain on mast.

Cost-effective retrofit options

- CB and slider Battcar systems use the same track; mix and match to optimize performance and budget.
- CB+ cars can be modified to run on Harken old-style, non-CB track produced until 2003; upgrade cars without replacing track. Look for the “+” symbol at the end of the car.



Mounting kit



Screwpin endstop kit



Flanged track



Drill-and-tap track

Easy mast-up installation

- Battcar track screws directly into slugs that slide into mast groove—no drilling or tapping.

Variety of mounting options

- Slugs for flat or round mast grooves; 1 kit per track section.
- Screwpin endstops to remove cars and mainsail; 1 kit per system.
- Mount flanged track to carbon spars; track features groove for racing sails with boltropes or slugs.
- Masts without internal track, attach Harken 13 - 32 mm traveler track by drilling and tapping the spar.

System AA

Typical boat size:

Monohulls: length to 11.3 m (37');
mainsail area under 32 m² (350 ft²)

Multihulls: length to 9.1 m (30');
mainsail area under 26 m² (275 ft²)

About CB and slider Battcar systems: see feature pages at beginning of this section.



3813



Jeanneau Sun Odyssey 349, 10.34 m (33'11"), Marc Lombard design
© Billy Black / Jeanneau



3815



3814



3816



Patented wire retaining clips keep balls captive, making cars easy to load and maintain.



Threaded stud and toggle design handles twisting and angled loads for quick hoisting and dousing.



Cars are easily removed from the track by freeing the screwpin endstop and sliding them off.

Part No.	Description	Length		Width		Weight		Max headboard thickness		Maximum working load	
		in	mm	in	mm	oz	g	in	mm	lb	kg
Typical Boat Length: monohulls to 11.3 m (37'); multihulls to 9.1 m (30')											
3813	CB headboard car assembly	5 3/16	132	1 9/16	40	6.7	188	1/2	12	440	200
3814	Slider intermediate car	1 3/4	44	1	25	0.5	15			130	59
3815	CB intermediate car	2 3/16	56	1 9/16	40	1.7	48			130	59
3816	CB Battcar/10 mm stud*	2 3/16	56	1 9/16	40	3	85			220	100

See page 277 for replacement balls. *Batten receptacle not included.

System AA

About CB and slider Battcar systems: See feature pages at beginning of this section.

Mast Track: Slug Mount

3817 track mounts to mast using a unique slug system that allows mast-up installation.

Part No.	Description	Length		Weight		Fastener spacing		Fastening method
		in	m	oz/ft	g/m	in	mm	
3817	Slug-mount track	80 3/4	2.05	2.84	264	3 15/16	100	Mounting slugs

Traveler Track: Drill/Tap

For masts without internal sail track, attach 2707 Micro traveler track by drilling and tapping the spar. Join track sections with splice links. Order one per track joint. Order one low-beam endstop (sold in pairs).

Part No.	Description	Splice link	Endstop	Ordering information	Fastening method

Mainsail luff length		Number of 3817 track sections
ft*	m*	
19'7" - 26'3"	5.98 - 8.00	4
26'4" - 33'	8.03 - 10.06	5
33'1" - 39'9"	10.08 - 12.11	6
39'10" - 46'5"	12.13 - 14.16	7

*Track extends above sail luff. Using screwpin endstop kits will increase lengths.

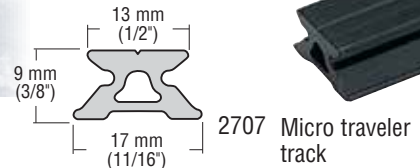
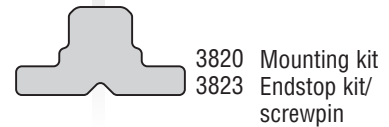
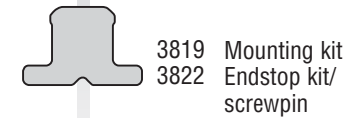
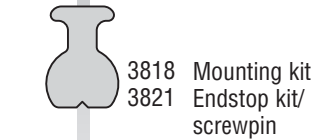
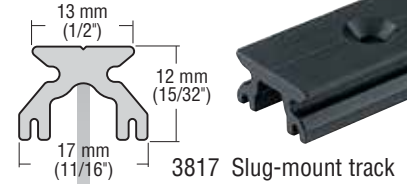

Kazahaya, Parigi 30, Alessandro Comuzzi architect © Alessandro Comuzzi

Mounting Kits and Endstops

Mounting kit slugs are available for flat or round mast grooves. Order one kit per track section.

Use screwpin endstop to easily remove cars and mainsail. Order one kit.

MOUNTING KIT

3818
3819
3820



MICRO TRACK ENDSTOP KIT/SCREWPIN

3837



ENDSTOP KIT/SCREWPIN

3821
3822
3823



Track Mounting Kits: Slug Mount*

Part No.	Description	Mounting slug				Connector slug				Fits flat mast groove gap					
		Length		Weight		Length		Weight		Min		Max			
		in	mm	oz	g	in	mm	oz	g	in	mm	in	mm		
3818	Round mast groove	3/4	19	0.14	4	19	2 5/8	67	0.54	15	1				
3819	Flat mast groove	3/4	19	0.17	5	19	2 5/8	67	0.6	17	1	5/16	8	7/16	11
3820	Wide flat mast groove	3/4	19	0.25	6	19	2 5/8	67	0.94	23	1	7/16	11	1/2	13

Endstop Kits: Slug Mount & Drill/Tap*

Part No.	Description	Track end length		Weight		Mounting slugs/kit
		in	mm	oz	g	
3821	Round mast groove/screwpin	6	152	2.4	70	2
3822	Flat mast groove/screwpin	6	152	2.4	70	2
3823	Wide flat mast groove/screwpin	6	152	2.4	70	2
3837	Micro track/screwpin	6	152	2.2	62	

*Includes M4 x .7 x 20 or 25 mm fasteners.

System A Battcars

Typical boat size:

Monohulls: length 11.3 - 15.2 m (37 - 50');
mainsail area under 56 m² (600 ft²)

Multihulls: length 9.1 - 12.2 m (30 - 40');
mainsail area under 46 m² (500 ft²)

About CB and slider Battcar systems:
see feature pages at beginning of this section.



Tofinou 12, 12 m (39.37'), Chantier Naval Latitude 46,
naval architect: Joubert / Nivelt © Chantier Naval Latitude 46



CB BALL BEARING CARS



SLIDER CARS

Part No.	Description	Length		Width		Weight		Max headboard thickness		Max batten Width		Ø	Batten	Maximum working load		
		in	mm	in	mm	oz	g	in	mm	in	mm			lb	kg	
CB Cars: Typical Boat Length: Monohulls 11.3 - 15.2 m (37 - 50'); Multihulls 9.1 - 12.2 m (30 - 40')																
3811*	Headboard car assembly	8 3/8	213	2 1/4	57	18	518	9/16	14					1600	725	
3889	Headboard car assembly/quick-release	9 1/2	240	2 1/4	57	21.5	610	9/16	14					1600	725	
3812*	Intermediate car	2 1/4	57	2 1/4	57	4	109							465	211	
3829*	Battcar/10 mm stud**	2 7/8	73	2 1/4	57	6	157							600	272	
3830*	Battcar/40 mm receptacle	2 7/8	73	2 1/4	57	9	253			1 5/8	41	5/8	16	Flat/Round	600	272
3881	Battcar/12 mm stud**	2 7/8	73	2 1/4	57	6.4	182							600	272	
3831	Universal Battcar**	2 7/8	73	2 1/4	57	4.3	122							600	272	
3882	Long batten car/12 mm stud**	4 1/8	105	2 1/4	57	8.2	232							875	397	
3883	Reef car	4 1/8	105	2 1/4	57	6.1	174							875	397	
Slider Cars: Typical Boat Length: Monohulls 11.3 - 15.2 m (37 - 50'); Multihulls 9.1 - 12.2 m (30 - 40')																
3827	Headboard car assembly	6	153	1 3/8	35	10	269	9/16	14					1600	725	
1777	Low-load intermediate car†	2	51	1 1/4	32	1.1	32							200	91	
3828	Intermediate car	1 3/4	44	1 3/8	35	1.6	45							350	159	
3802	Battcar/10 mm stud**	1 3/4	44	1 3/8	35	2.8	80							350	159	
3803	Battcar/40 mm receptacle	1 3/4	44	1 3/8	35	6.38	181			1 5/8	41	5/8	16	Flat/Round	350	159

See page 277 for replacement balls. *Available as a non-CB car on a car loader to run on a non-CB style track supplied before 2003. Add .NW to end of part number.

138 † Max. sail area: Monohull 33 m² (350 ft²), Multihull 28 m² (300 ft²). **Batten receptacle not included.

System A

About CB and slider Battcar systems: See feature pages at beginning of this section.

Mast Track

3807 track mounts to mast using a unique slug system that allows mast-up installation.

Use flanged track when mounting to carbon spars. Track features a groove for racing sails with boltropes or slugs.

Part No.	Description	Length		Weight		Fastener spacing		Fastening method
		in	m	oz/ft	g/m	in	mm	
3807	Slug-mount track	80 3/4	2.05	4.44	413	4 15/16	125	Mounting slugs
3878.2M	Flanged track	78 3/4	2	6.7	626			Adhesive
3878.6M	Flanged track	236 1/4	6	6.7	626			Adhesive

Traveler Track: Drill/Tap

For masts without internal sail track, attach 2720 Small Boat traveler track by drilling and tapping the spar. Join track sections with splice links. Order one per track section. Order one low-beam endstop (sold in pairs).

Part No.	Description	Splice link	Endstop	Ordering information	Fastening method
2720	Small Boat track	2724	263	page 104	Drilling and tapping

Mounting Kits and Endstops

Mounting kit slugs are available for flat or round mast grooves. Order one kit per track section.

Use screwpin endstop to easily remove cars and mainsail. Order one kit only.

MOUNTING KIT

3804
3805
3806



ENDSTOP KIT/FIXED

3808
3809
3810



Mainsail luff length		Number of 3807 track sections
ft*	m*	
26'4" - 33'	8.03 - 10.06	5
33'1" - 39'9"	10.08 - 12.11	6
39'10" - 46'5"	12.13 - 14.16	7
46'6" - 53'2"	14.19 - 16.21	8
53'3" - 59'11"	16.24 - 18.26	9

*Track extends above sail luff. Using screwpin endstop kits will increase lengths.

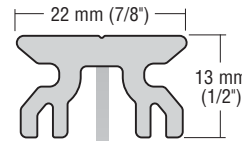

3807 Slug-mount track

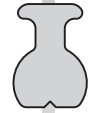

3804 Mounting kit
3808 Endstop kit/fixe
3824 Endstop kit/screwpin



3805 Mounting kit
3809 Endstop kit/fixe
3825 Endstop kit/screwpin



3806 Mounting kit
3810 Endstop kit/fixe
3826 Endstop kit/screwpin

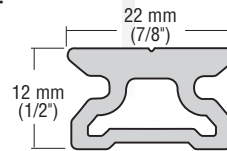

2720 Small Boat traveler track

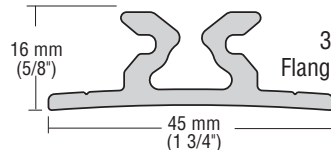

3878 Flanged track

ENDSTOP KIT/SCREWPIN

3824
3825
3826



Track Mounting Kits: Slug Mount*

Part No.	Description	Mounting slug				Connector slug				Fits flat mast groove gap					
		Length in	Length mm	Weight oz	Weight g	Length in	Length mm	Weight oz	Weight g	Connector slugs/kit	Min in	Min mm	Max in	Max mm	
3804	Round mast groove	3/4	19	0.14	4	15	2 5/8	67	0.54	15	1				
3805	Flat mast groove	3/4	19	0.17	5	15	2 5/8	67	0.6	17	1	5/16	8	7/16	11
3806	Wide flat mast groove**	3/4	19	0.25	6	15	2 5/8	67	0.94	23	1	7/16	11	5/8	16

Endstop Kits: Slug Mount*

Part No.	Description	Track end length		Weight		Mounting slugs/kit
		in	mm	oz	g	
3808	Round mast groove/fixe (pair)			0.5	14	2
3809	Flat mast groove/fixe (pair)			0.52	15	2
3810	Wide flat mast groove/fixe (pair)			0.67	19	2
3824	Round mast groove/screwpin	8	203	5.4	155	3
3825	Flat mast groove/screwpin	8	203	5.5	157	3
3826	Wide flat mast groove/screwpin	8	203	6.1	174	3

*Includes M5 X .8 X 20/25 mm or 25 mm fasteners.

System B

Typical boat size:

Monohulls: length 15.2 - 18.3 m (50 - 60');
mainsail area under 83 m² (900 ft²)

Multihulls: length 12.2 - 15.2 m (40 - 50');
mainsail area under 65 m² (700 ft²)

About CB and slider Battcar systems: see feature pages
at beginning of this section.



Designed to work with batten receptacles from New Zealand's C-Tech Sailbattens, the pintles have shoulders that protect the threads from bending.



3852



3859



3856
3857
3879



3893



3860



3863

CB BALL BEARING CARS



3833



3834
3835



3836

SLIDER CARS



3861



3862

Aluminum web-on headboard plates are easy for sailmakers to install. Plates have radiused edges to protect the sail and fit 25 mm (1") webbing strap. Holes threaded into plates accept 416 cheek blocks for leech line. Web-on plates are required for the 3852 System B CB headboard car. Sold separately.

HEADBOARD PLATES

Part No.	Description	Length		Width		Weight		Max headboard thickness		Maximum working load	
		in	mm	in	mm	oz	g	in	mm	lb	kg
CB Cars: Typical Boat Length: Monohulls 15.2 - 18.3 m (50 - 60'); Multihulls 12.2 - 15.2 m (40 - 50')											
3852*	Headboard car assembly	10 1/2	267	2 3/4	70	41.4	1173	7/16	12	3200	1450
3863*	Intermediate car	2 9/16	68	2 3/4	70	6.8	191			524	238
3856*	Battcar/10 mm stud**	4 1/4	108	2 3/4	70	14.3	406			1260	571
3857	Battcar/12 mm stud**	4 1/4	108	2 3/4	70	14.6	413			1260	571
3879	Battcar/14 mm stud**	4 1/4	108	2 3/4	70	15.1	429			1260	571
3859	Universal Battcar**	4 1/4	108	2 3/4	70	12.3	348			1260	571
3860	Reef car	5 3/16	132	2 3/4	70	14.4	408			1600	725
3861	Web-on headboard plate ‡	6 3/4	172	6 3/8	161	10.3	292				
3862	Web-on headboard plate/flat-top ‡	5 13/16	148	6 3/16	157	11.2	317				
3893	Battcar/M12 stud for C-Tech batten	4 1/4	108	2 3/4	70	14.9	423			1260	571
Slider Cars: Typical Boat Length: Monohulls 15.2 - 18.3 m (50 - 60'); Multihulls 12.2 - 15.2 m (40 - 50')											
3833	Headboard car assembly † ‡	7 1/2	190	1 11/16	42	14.8	420	9/16	16	3200	1450
3836	Intermediate car	2 3/16	56	1 11/16	42	2.9	82			1260	571
3834	Battcar/10 mm stud**	2 3/16	56	1 11/16	42	4.5	128			1260	571
3835	Battcar/12 mm stud**	2 3/16	56	1 11/16	42	4.9	140			1260	571

See page 277 for replacement balls. *Available as a non-CB car on a car loader to run on a non-CB style track supplied before 2004. Add .NW to end of part number.

140 **Batten receptacle not included. † Contact Harken for headboard plate for non CB systems. ‡ †Fits standard sailmaker-supplied headboard.

System B

About CB and Slider Battcar systems: see feature pages at beginning of this section.

Mainsail luff length		Number of 3844 track section
ft*	m*	
39'10" - 46'6"	12.13 - 14.17	7
46'7" - 53'3"	14.19 - 16.23	8
53'4" - 60'	16.25 - 18.29	9
60'1" - 66'9"	18.31 - 20.35	10
66'10" - 73'6"	20.37 - 22.44	11

*Track extends above sail luff. Using screwpin endstop kits will increase lengths.

Mast Track

3844 track mounts to mast using a unique slug system that allows mast-up installation.

Use flanged track when mounting to carbon spars. Track features a groove for racing sails with boltropes or slugs. Use C10879 endstop feeder kit to easily raise sails with boltropes.

Part No.	Description	Length		Weight		Fastener spacing		Fastening method
		in	m	oz/ft	g/m	in	mm	
3844	Slug-mount track	81 1/8	2.06	5.66	527	3 15/16	100	Mounting slugs
3849.2M	Flanged track	78 3/4	2	12	1119			Adhesive
3849.6M	Flanged track	236 1/4	6	12	1119			Adhesive
C10879	Endstop/feeder kit*	15 3/4	0.4	22.4	636	2 15/16	75	Fasteners/adhesive

*Use with 3849 flanged track. Contact Harken for price and lead time.

Traveler Track: Drill/Tap

For masts without internal sail track, attach R27 Midrange traveler track by drilling and tapping the spar. Join track sections with splice links. Order one per track section. Order one low-beam endstop (sold in pairs).

Part No.	Description	Splice link	Endstop	Ordering information	Fastening method
R27	Midrange track	1619	E2700	Page 109	Drilling and tapping

Mounting Kits and Endstops

Mounting kit slugs are available for flat or round mast grooves. Order one kit per track section.

Use pinstop endstop to easily remove cars and mainsail. Order one kit only.



3845
3846
3864

MOUNTING KIT



3850
3851
3865

ENDSTOP KIT/FIXED



3847
3848
3866

ENDSTOP KIT/SCREWPIN



C10879

ENDSTOP/FEEDER KIT

Track Mounting Kits: Slug Mount*

Part No.	Description	Mounting slug				Mounting slugs/kit	Connector slug				Fits flat mast groove gap				
		Length	Weight	Length	Weight		Length	Weight	Connector slugs/kit	Min	Max	Min	Max		
3845	Round mast groove	7/8	22	0.43	12	19	3	76	1.27	36	1	7/16	11	5/8	16
3846	Flat mast groove	7/8	22	0.56	16	19	3	76	1.71	48	1	7/16	11	5/8	16
3864	Flat mast groove**	7/8	22	0.48	14	19	3	76	1.29	37	1	3/8	9.5	7/16	11

Endstop Kits: Slug Mount*

Part No.	Description	Track end length		Weight		Mounting slugs/kit
		in	mm	oz	g	
3847	Round mast groove/pinstop	9 1/2	241	8.3	234	3
3848	Flat mast groove/pinstop	9 1/2	241	11.3	322	3
3850	Round mast groove/fixd (pair)			3.3	94	2
3851	Flat mast groove/fixd (pair)			3.7	105	2
3865	Flat mast groove/fixd**			3.5	100	2
3866	Flat mast groove/pinstop**	9 1/2	241	11.1	316	3

*Includes M6 x 1.0 x 20 or 30 mm fasteners; weights include fasteners; not for flanged track. **For Selden mast section C installations.

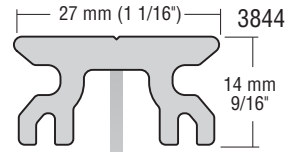

3844 Slug-mount track



3845 Mounting kit
3847 Endstop kit/pinstop
3850 Endstop kit/fixd

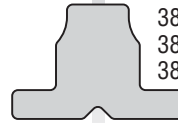

3846 Mounting kit
3848 Endstop kit/pinstop
3851 Endstop kit/fixd

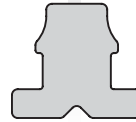

3864 Mounting kit
3865 Endstop kit/fixd
3866 Endstop kit/pinstop

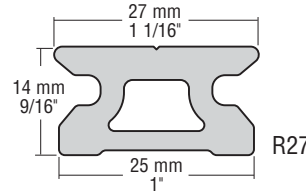

R27 Midrange traveler track

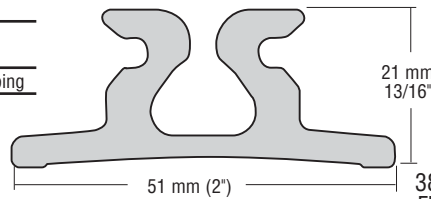

3849 Flanged track

System C

Typical boat size:

Monohulls: length 18.3 - 27 m (60 - 90');
mainsail area under 180 m² (1940 ft²)

Multihulls: length 15.2 - 21 m (50 - 70');
mainsail area under 140 m² (1510 ft²)

About CB and slider Battcar systems: see feature pages
at beginning of this section.

Pelagic Belle, Knysna 500, Angelo Lavranos, Knysna Yacht Company © Rika Fouché



3867



3873



3872

3868
3869
38703890
3891
3945

3871



Designed to work with batten receptacles from New Zealand's C-Tech Sailbattens, the pintles have shoulders that protect the threads from bending.



3876



3877

Aluminum web-on headboard plates are easy for sailmakers to install. Plates have radiused edges to protect the sail and fit 25 mm (1") webbing strap. Holes threaded into plates accept 416 cheek blocks for leech line. Web-on plates are required for the 3867 System C CB headboard car. Sold separately.

Part No.	Description	Length		Width		Height		Weight		Max headboard thickness		Maximum working load	
		in	mm	in	mm	in	mm	oz	g	in	mm	lb	kg
CB Cars: Typical Boat Length: Monohulls 18.3 - 27 m (60 - 90'); Multihulls 15.2 - 21 m (50 - 70')													
3867	Headboard car assembly*	18 5/8	473	3 3/8	85			107	2980	9/16	15	6300	2858
3871	Intermediate car	3 3/4	96	3 3/8	85			17	493			1530	695
3868	Battcar/12 mm stud**	5 3/8	136	3 3/8	85			29	834			2100	953
3869	Battcar/14 mm stud**	5 3/8	136	3 3/8	85			30	844			2100	953
3870	Battcar/16 mm stud**	5 3/8	136	3 3/8	85			31	860			2100	953
3872	Universal Battcar**	5 3/8	136	3 3/8	85			24	676			2100	953
3873	Reef car	9 1/8	231	3 3/8	85			38	1071			3150	1429
3876	Web-on headboard plate*	10 15/16	278	9/16	14	10 5/8	269	33.8	958.4	1/2	13		
3877	Web-on headboard plate/flat-top*	11 1/16	281	9/16	14	11 5/16	288	43	1343	1/2	13		
3890	Battcar/M12 stud for C-Tech batten**	5 3/8	136	3 3/8	85			29.5	836			2100	953
3891	Battcar/M14 stud for C-Tech batten**	5 3/8	136	3 3/8	85			29.9	847			2100	953
3945	Battcar/M16 stud for C-Tech batten**	5 3/8	136	3 3/8	85			31.5	894			2100	953

See page 277 for replacement balls. *Contact Harken for headboard plate for older systems. **Batten receptacle not included.

System C

About CB and slider Battcar systems: See feature pages at beginning of this section.

Mast Track

3853 track mounts to mast using a unique slug system that allows mast-up installation.

Use flanged track when mounting to carbon spars. Track features a groove for racing sails with boltropes or slugs.

Part No.	Description	Length		Weight		Fastener spacing		Fastening method
		in	m	oz/ft	g/m	in	mm	
3853	Slug-mount track	81 15/16	2.08	9.28	863	3 15/16	100	Mounting slugs
3858.2M	Flanged track	78 3/4	2	17.38	1619			Adhesive
3858.6M	Flanged track	236 1/4	6	17.38	1619			Adhesive

Traveler Track: Drill/Tap

For masts without internal sail track, attach R32 Big Boat traveler track by drilling and tapping the spar. Join track sections with splice links. Order one per track section. Order one low-beam endstop (sold in pairs).

Part No.	Description	Splice link	Endstop	Ordering information	Fastening method
R32	Big Boat track	3153	E3200	page 115	Drilling and tapping

Mounting Kits and Endstops

Mounting kit slugs are available for flat mast grooves. Order one kit per track section.

Use pinstop endstop to easily remove cars and mainsail. Order one kit only.

MOUNTING KIT

3854



ENDSTOP KIT/FIXED

3855



ENDSTOP KIT/SCREWPIN

3875



Track Mounting Kits: Slug Mount

Part No.	Description	Mounting slug				Mounting slugs/kit	Connector slug				Fits flat mast groove gap				
		Length in	mm	Weight oz	g		Length in	mm	Weight oz	g	Connector slugs/kit	Min in	mm	Max in	mm
3854	Flat mast groove	1	25	0.6	17	19	4 1/8	105	2.49	70	1	17/32	13	5/8	16

Endstop Kits: Slug Mount

Part No.	Description	Track end length		Weight		Mounting slugs/kit
		in	mm	oz	g	
3855	Flat mast groove/fixd (pair)*			16	454	2
3875	Flat mast groove/pinstop*	17	432	30	853	5

M8 x 1.25 x 40 mm fasteners. *Not for flanged track.

Mainsail luff length		Number of 3853 track sections
ft*	m*	
53'8" - 60'5"	16.36 - 18.42	9
60'6" - 67'3"	18.45 - 20.50	10
67'4" - 74'1"	20.53 - 22.58	11
74'2" - 80'11"	22.61 - 24.66	12
81' - 87'9"	24.69 - 26.74	13
87'10" - 94'7"	26.77 - 28.82	14
94'8" - 101'5"	28.85 - 30.90	15

*Track extends above sail luff. Using screwpin endstop kits will increase lengths.

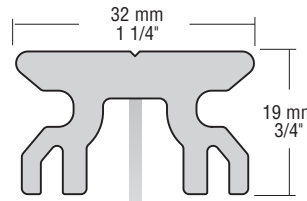

3853 Slug-mount track



3854 Mounting kit
3855 Endstop kit/fixd
3875 Endstop kit/pinstop

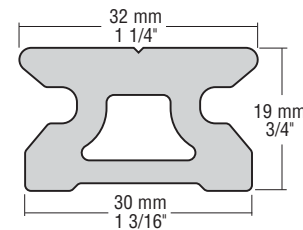

R32 Big Boat traveler track

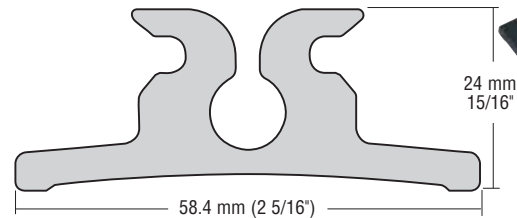

3858 Flanged track



Devolo, Solaris 68', 20.80 m (68.24'), Solaris Yachts, naval architect: Javier Soto Acebal © Solaris Yachts

SWITCH T-TRACK BATTCAR SYSTEMS

Harken's award-winning Switch T-Track Battcar system cuts the stack height of mainsails on large yachts by half, making it much easier for crew to put on sail covers and to connect/disconnect halyards. This simple, yet sophisticated patented switch system neatly stacks cars side-by-side on top of the boom. The unique switch plate has no moving parts, ensuring an exceptionally reliable and efficient product. Available in 18, 26, 32, and 40 mm sizes for monohulls 11 m (37') to over 43 m (140'); multihulls 9 m (30') to over 27 m (90').



Switch track cuts stack height in half

- Neatly flakes mainsail on top of the boom; stores cars on parallel tracks.
- Headboard cars articulate, pass through switch for further stack height reduction (26 and 32 mm).
- Long switches available to accommodate more cars on boats with large sail areas.

Stand up to sun, salt, and time

- 18 mm high-load, 26, 32, and 40 mm aluminum cars Hard Lube-anodized, UV-stabilized for durability.
- Standard 18 mm cars fiber-reinforced, UV-stabilized, lubricated composite for maximum protection and low wear.
- Aluminum track hardcoat-anodized for a long-lasting surface.
- Switch plate has no moving parts to break.



Materials

For properties see pages 16-17.



6061-T6

aluminum:

Hard Lube-anodized cars; hardcoat-anodized track

Do not use Harken equipment for human suspension unless product is specifically certified and labeled for such use.



Low-friction components

- Cars run on low-friction plastic slides.
- Switch plate with no moving parts minimizes friction.

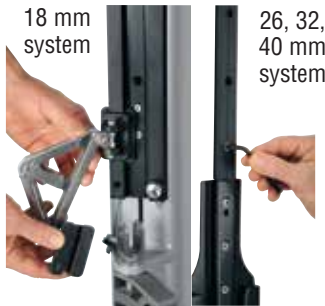

Easy installation/removal of cars

- Gate tracks for 26, 32, 40 mm cars feature easy-to-remove fasteners to load/unload cars.
- 18 mm switch track uses screwpin stops and stop at masthead for easy car removal.



Optional Trysail Switch system reduces weight aloft

- Integrates trysail with mainsail switch systems; shares track.
- Cars switch automatically—only trysail cars travel onto the trysail track; mainsail cars pass through to switch and storage tracks.
- All track is hardcoat-anodized.
- Available in 26, 32, and 40 mm sizes.



18 & 26 mm slug-mount track

18, 26, 32 mm drill-and-tap track



26, 32 & 40 mm flange track

Variety of mounting options

- 18 and 26 mm slug-mount track converts masts with sail grooves for mast-up installation. Boats under 12.2 m (40') use standard slug-mount track. Boats from 12.2 - 13.7 m (40' - 45') require 18 mm high-load slug-mount track at full hoist and all reef point headboard locations. 18 mm systems available for round, flat, or wide flat mast grooves. Boats from 13.7 - 24.4 m (45' - 80') use 26 mm slug-mount track. 26 mm available with flat mast groove slugs.
- 18, 26, 32 mm drill/tap track and switches fit masts without sail grooves; join track sections with splice links.
- 26, 32, and 40 mm flange track is available in bond and bolt-down versions. Bond track is joined to the mast with a structural adhesive to reduce weight aloft; eliminates the majority of track fasteners for lighter-weight system. Consult mast builder for bond track installation recommendations.

18 mm Switch T-Track Battcar Systems

Typical boat size:

18 mm: Monohulls: 11 - 13.5 m (37 - 45');
 Multihulls: 9 - 10.5 m (30 - 35')
 18 mm high-load:
 Monohulls 13.5 - 15 m (45 - 50');
 Multihulls 10.5 - 12 m (35 - 40')

About Switch T-Track Battcar systems: see feature pages at beginning of this section.

Designed to work with batten receptacles from New Zealand's C-Tech Sailbattens, the pintles have shoulders that protect the threads from bending.



3892



HC7905



HC8537



HC7906



HC7906HL



HC7905HL



HC7904HL
 HC8537HL

INTERMEDIATE CARS

BATTEN CARS

HEADBOARD CARS

Cars

Part No.	Description	Length		Width		Weight		Max headboard thickness		Maximum sail area		Maximum working load			
		in	mm	in	mm	oz	g	in	mm	ft ²	m ²	ft ²	m ²	lb	kg
18 mm															
HC7906	Headboard car	7 3/16	198	1 21/32	42	12.8	359	9/16	14	450	40	325	30	700	318
HC7905	Intermediate car	2 1/2	63	1 21/32	42	1.6	45			450	40	325	30	300	103
HC8537	Batten car/10 mm stud	2 1/2	63	1 21/32	42	3.2	91			450	40	325	30	300	103
18 mm High-Load (HL)															
3892	Battcar/M12 stud for C-Tech batten	2 1/2	63	1 11/16	42	4.8	135			610	55	500	45	600	272
HC7906HL	Headboard car	7 3/16	198	1 21/32	42	14.4	408	9/16	14	610	55	500	45	1600	725
HC7905HL	Intermediate car	2 1/2	63	1 21/32	42	3.2	91			610	55	500	45	600	272
HC7904HL	Batten car/12 mm stud	2 1/2	63	1 21/32	42	4.9	139			610	55	500	45	600	272
HC8537HL	Batten car/10 mm stud	2 1/2	63	1 21/32	42	4.8	136			610	55	500	45	600	272

Xc 42, Niels Jeppesen © X-Yachts



Cut car stack height in half by flaking the sail alternately to port and starboard of the boom.

BATTCAR Q&A

WHY DO I WANT A SWITCH BATTCAR SYSTEM?

A Switch Battcar system cuts stack height in half, so putting on a sail cover or connecting/disconnecting your halyard is a much easier task. The patented system works by alternately dropping mainsail cars onto port and starboard storage racks. Headboard cars articulate and pass through the switch, reducing stack height even more.

18 mm Switch T-Track Battcar Systems

For masts with sail grooves, 18 mm slug-mount track uses a unique system that allows mast-up installation. Use high-load slug-mount tracks on boats over 12.2 m (40') at sail headboard locations at full hoist and headboard locations when sail is reefed. Drill/tap track and switches fit masts without sail grooves. Join drill/tap track sections with splice links. Order one per track section. Boats with larger sail areas should use long switches to accommodate more cars.

Mounting Kits and Endstops

Slug mounting kits are available for flat or round mast grooves. Order one kit per track section.

Switch track includes screwpin stops for easy car and sail removal below switch. Stop at masthead also included.

About Switch T-Track Battcar systems: see feature pages at beginning of this section.

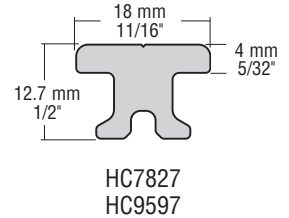
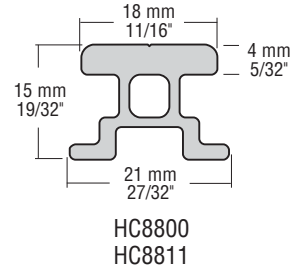
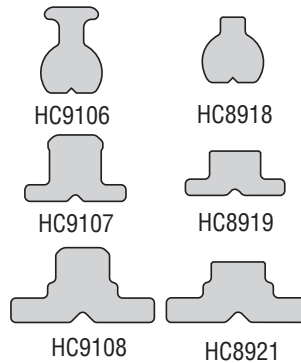

HC8230

HC7827

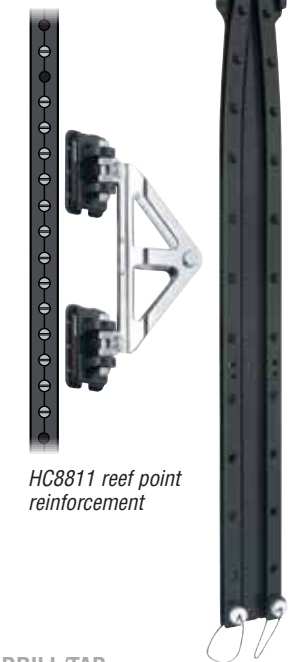

HC8811 reef point reinforcement

SLUG MOUNT

Mounting Kits: Slug Mount

Part No.	Description	Mounting slug				Connector slug				Flat mast groove gap				
		Length in	Weight mm	oz	g	Mounting slugs/kit	Length in	Weight mm	oz	g	Connector slugs/kit	Min in	Max in	
Switch Mounting Kits														
HC8918	Round mast groove	2	51	0.32	9	3								
HC8919	Flat mast groove	1 3/4	45	0.28	8	3					5/16	8	7/16 11	
HC8921	Wide flat mast groove	1 3/4	45	0.56	16	3					7/16	11	5/8 16	
Track Mounting Kits														
HC9106	Round mast groove	3/4	19	0.14	4	19	2 5/8	67	0.54	15	1			
HC9702	Round mast groove, extras*	3/4	19	0.14	4	10								
HC9107	Flat mast groove	3/4	19	0.17	5	19	2 5/8	67	0.6	17	1	5/16	8	7/16 11
HC9703	Flat mast groove, extras*	3/4	19	0.17	5	10						5/16	8	7/16 11
HC9108	Wide flat mast groove	3/4	19	0.25	6	19	2 5/8	67	0.94	23	1	7/16	11	5/8 16
HC9704	Wide flat mast groove, extras*	3/4	19	0.25	6	10						7/16	11	5/8 16

*Extra slug kit for HC8811 track. Order one kit in addition to HC9106, HC9107 or HC9108 for sail headboard location at full hoist and one kit for each reefed headboard location.

Track

Part No.	Description	Length		Width		Weight		Fasteners mm	Fastener spacing mm
		in	mm	in	mm	oz	g		
Slug Mount									
HC8798	Switch/short	24	610	2 5/8	67	32	907	5	
HC8799	Switch/long	33 3/4	857	2 5/8	67	47	1336	5	
HC8800	T-Track	80 13/16	2051	27/32	21	26.7	758	5	100
HC8811	T-Track/high-load**	80 13/16	2051	27/32	21	26	748	5	50/100
Drill/Tap									
HC10417	Switch***	33 3/4	857	3	76	26.7	758	5	75
HC7827	3 m T-Track	118 1/8	3000	23/32	18	38.9	1106	5	75
HC9597	2 m T-Track/high load	78 3/4	2000	23/32	18	25.5	723	5	50
HC8230	Splice link	7/8	22	1/8	3.2	0.02	0.57		

** Use HC8811 high-load track on upper part of mast to reinforce HL system headboard locations. Mount using 50 mm hole spacing at headboard location at full hoist and headboard location at each reef point. Reduce weight in other areas by alternating holes to 100 mm spacing.

***Switch may be shortened to 605 mm (23 13/16").

26 mm, 32 mm Switch T-Track Battcar Systems

Patented Battcar switch systems cut sail stack height in half by automatically splitting cars onto two tracks.

Use HC8879 and HC8880 for headboard reefed position. See page 151. Gate track is removed to load and unload cars.

Spherical bushings let headboard cars pass through switch.

Typical boat size:

- 26 mm: Monohulls: 15 - 24 m (50 - 80');
Multihulls: 12 - 18 m (40 - 60')
- 32 mm: Monohulls: 24 - 43 m (80 - 140');
Multihulls: 18 - 27 m (60 - 90')

About Switch T-Track Battcar systems: see feature pages at beginning of this section.

HEADBOARD CAR ASSEMBLY

HC9045 and HC9046 use 3876 or 3877 headboard plates.**



HC9045
HC9046



Designed to work with batten receptacles from New Zealand's C-Tech Sailbattens, the pintles have shoulders that protect the threads from bending.



HC7493



HC7322



HC7325



HC8076



HC8125
HC8099



HEADBOARD PLATES

INTERMEDIATE CARS

REEF CARS

TACK CAR



HC7324



HC8098



HC7316



3894
3896
3897



3895

BATTEN CARS

Cars

Part No.	Description	Length		Width		Weight		Max headboard thickness		Maximum sail area				Maximum working load	
		in	mm	in	mm	oz	g	in	mm	ft ²	m ²	ft ²	m ²	lb	kg
26 mm															
HC9045	Headboard car*	10 5/8	270	2 3/8	60	34.3	973	21/32	17	1730	160	1300	120	4500	2045
HC7493	Intermediate car	2 3/8	60	2 3/8	60	5.6	159			1730	160	1300	120	1000	454
HC7324	Batten car/12 mm stud	2 15/16	75	2 3/8	60	8.8	250			1730	160	1300	120	1500	680
HC7325	Reef car*	3 17/32	90	2 3/8	60	7.2	205			1730	160	1300	120	2100	952
HC8125	Tack car	3 17/32	90	4 3/8	111.2	14.4	409			1730	160	1300	120	3800	1723
3894	Battcar/M12 stud for C-Tech batten	2 15/16	75	2 3/8	60	9.1	257			1730	160	1300	120	1500	680
3895	CRX Battcar/M12 stud for C-Tech batten	4 1/2	115	2 3/8	60	12.6	357			1730	160	1300	120	1500	680
32 mm															
HC9046	Headboard car*	11	280	2 3/4	70	44.7	1266	21/32	17	3780	350	2400	225	8000	3628
HC7322	Intermediate car	2 15/16	75	2 3/4	70	10.4	297			3780	350	2400	225	2800	1270
HC8098	Batten car/12 mm stud	3 17/32	90	2 3/4	70	11.2	319			3780	350	2400	225	4000	1814
HC7316	Batten car/14 mm stud	3 17/32	90	2 3/4	70	11.2	319			3780	350	2400	225	4000	1814
HC8076	Reef car*	4 17/32	115	2 3/4	70	14.4	409			3780	350	2400	225	6000	2722
HC8099	Tack car	4 17/32	115	5 3/16	132	29.2	830			3780	350	2400	225	7900	3583
3896	Battcar/M12 stud for C-Tech batten	3 17/32	90	2 3/4	70	17.1	487			3780	350	2400	225	4000	1814
3897	Battcar/M14 stud for C-Tech batten	3 17/32	90	2 3/4	70	17.2	489			3780	350	2400	225	4000	1814
Headboard Plates															
3876	Web-on headboard plate**	10 15/16	278	9/16	14	33.8	958.4	1/2	13						Fits HC9045/HC9046
3877	Web-on headboard plate/flat-top**	11 1/16	281	9/16	14	43	1343	1/2	13						Fits HC9045/HC9046

*May increase mwl by using track with closer hole spacing; contact Harken. **Contact Harken for headboard plate for older systems and boats

Switch T-Track Battcar Systems: 26, 32 mm

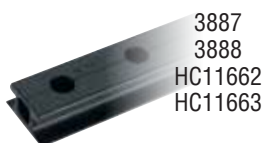
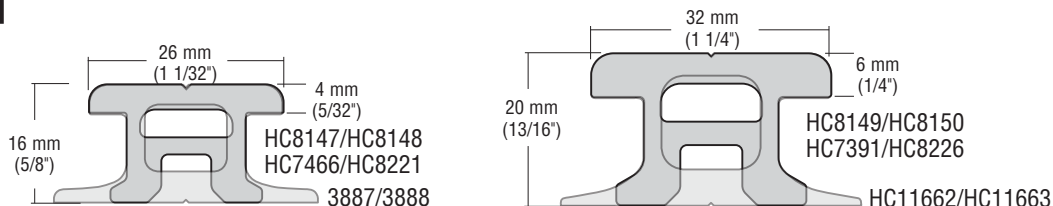

Track Mounting Kits: Slug-Mount

Part No.	Description	Mounting slug length in mm	Mounting slugs/ kit	Weight (kit) oz g	Fasteners (included) mm	Track
3884	Track slug-mounting kit/flat mast groove	1 25	40	28 790	40 x M6 x 1.0 x 18 mm	HC7466, HC8879

Endstop Kits: Slug-Mount

Part No.	Description	Mounting slug length in mm	Mounting slugs/ kit	Track length in mm	Weight (kit) oz g	Fasteners (included) mm
3885	Endstop kit/flat mast groove*	1 13/32	36	1	2.25 64	2 x M6 x 1.0 x 35 mm
3886	Gate track mounting kit/flat mast groove**	1 25	4	11 13/16	300 9.25 260	4 x M6 x 1.0 x 18 mm

*Includes 1522ASSY. **Includes HC8221.

Track & Accessories

Part No.	Description	Length		Width		Weight		Fasteners	Fastener spacing
		in	mm	in	mm	oz	g	mm	mm
26 mm									
3887	Flange track/bolt-down*	74 3/4	1899	1 1/32	26	41.6	1180	6	50
3888	Flange track/bond*	153 1/2	3899	1 1/32	26	88.2	2500	6	3850
HC8220	Switch*	25 1/4	641	4	102	43.1	1225	6	
HC8147	500 mm storage track*	19 11/16	500	1 1/32	26	10.2	291	6	50
HC8148	725 mm storage track*	28 17/32	725	1 1/32	26	14.8	419	6	50
HC10060	725 mm double storage track*	28 17/32	725	3 11/16	93	57.2	1623	6	50
HC7466	3 m T-Track*	118 1/8	3000	1 1/32	26	61.1	1736	6	75
HC8879	2 m T-Track/high-load*	78 3/4	2000	1 1/32	26	40.3	1141	6	50
HC8221	Gate track*	11 13/16	300	1 1/32	26	6.1	174	6	75
HC8222	Splice link			1 1/32	26	0.1	3		
1522ASSY	Endstop	2 5/32	55	1 17/32	39				
32 mm									
HC7382	Switch*	28 1/2	724	5	127	72.8	2068	8	
HC8149	800 mm storage track*	31 1/2	800	1 1/4	32	25.6	728	8	50
HC8150	1025 mm storage track*	40 11/32	1025	1 1/4	32	32.8	933	8	50
HC7391	3 m T-Track*	118 1/8	3000	1 1/4	32	96.2	2734	8	75
HC8880	2 m T-Track/high-load*	78 3/4	2000	1 1/4	32	63.1	1790	8	50
HC8226	Gate track*	11 13/16	300	1 1/4	32	9.6	273	8	75
HC8227	Splice link					0.2	5		
HC11662	Flange track/bolt-down*	74 3/4	1899	1 1/4	32	62.1	1760	8	50
HC11663	Flange track/bond*	153 1/2	3899	1 1/4	32	136.2	3860	8	3850
548ASSY	Endstop	2 27/32	72	2 1/32	52				

*Available in black or clear anodized.



40 mm Switch T-Track Battcar Systems

Patented Battcar switch systems cut sail stack height in half by automatically splitting cars onto two tracks.

Typical boat size:

Monohulls: over 43 m (140');
 Multihulls: over 27 m (90')

About Switch T-Track Battcar systems: see feature pages at beginning of this section.



SW-RP90 CUSTOM, Courtesy of Southern Wind Shipyard



Replacement Studs

Part No.	Description	Ø		Fits
		in	mm	
3929	18 mm toggle/stud	23/32	18	3926, 3931, 3932
3930	16 mm toggle/stud	5/8	16	3926, 3931, 3932

Cars

Part No.	Description	Length		Width		Weight		Maximum sail area				Maximum working load	
		in	mm	in	mm	oz	g	Monohull	Multihull		lb	kg	
3921	Non-locking headboard car assembly	13 3/4	349	3 1/2	89	151	4280	3780 +	350 +	2400 +	275 +		
3924	Intermediate car	3 21/32	93	3 1/2	89	14	392	3780 +	350 +	2400 +	275 +	3549	1613
3932	Batten car/16 mm stud	5 1/32	128	3 1/2	89	34.5	979	3780 +	350 +	2400 +	275 +	5940	2700
3931	Batten car/18 mm stud	5 1/32	128	3 1/2	89	35.3	1000	3780 +	350 +	2400 +	275 +	5940	2700
3925	CRX roller batten car	6 1/16	153	3 1/2	89	37	1045	3780 +	350 +	2400 +	275 +	5940	2700
3926	Universal batten car	5 1/32	128	3 1/2	89	22	617	3780 +	350 +	2400 +	275 +	5940	2700
3923	Reef car	6 1/16	153	3 1/2	89	30	843	3780 +	350 +	2400 +	275 +	8998	4090
3922	Tack car	6 1/16	153	7 1/4	184	81	2303	3780 +	350 +	2400 +	275 +	13200	6000

Headboard Plate

3920	Web-on headboard plate	13 11/16	348	5/8	16	70.2	1990						
------	------------------------	----------	-----	-----	----	------	------	--	--	--	--	--	--

Contact Harken to request lead time. If your boat or sail area is larger than the lengths and sail areas listed, please contact Harken.

NEW

Switch T-Track Battcar Systems: 40 mm



Claude, Baltic 68, 19.5 m (64'), naval architect: Reichel Pugh Yacht Design © Baltic Yachts

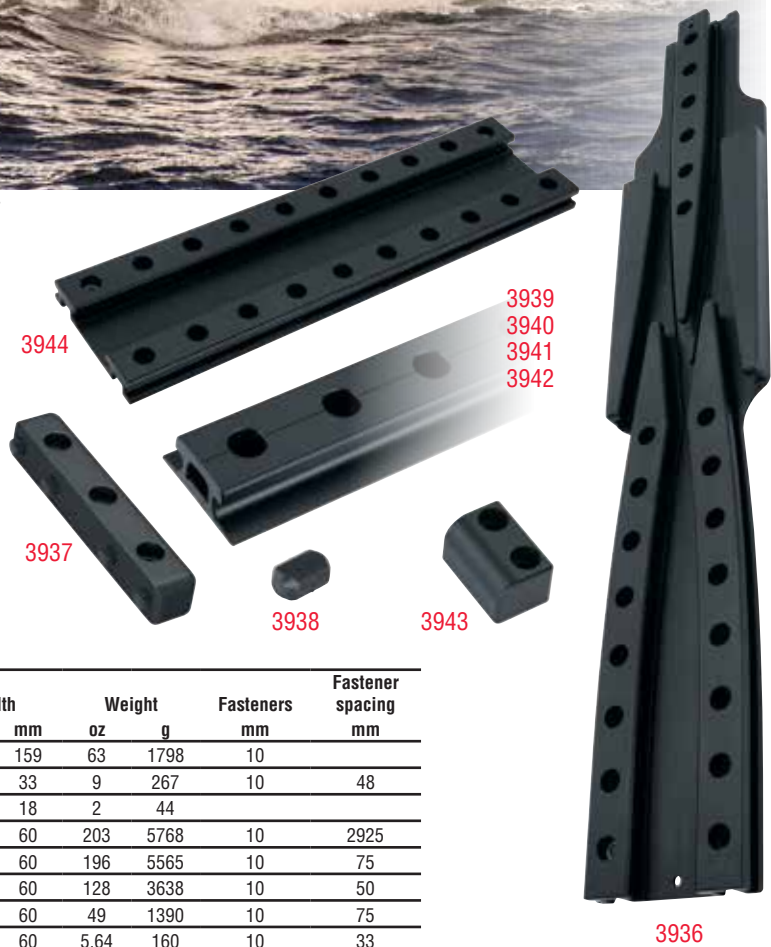
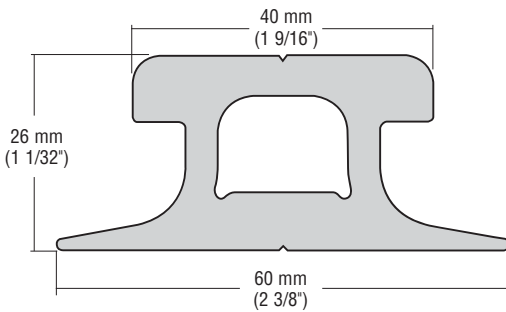

Track & Accessories

Part No.	Description	Length		Width		Weight		Fasteners	Fastener spacing
		in	mm	in	mm	oz	g		
3936	Switch*	36 1/2	927	6 1/4	159	63	1798	10	
3937	Endstop*	5 13/16	148	1 5/16	33	9	267	10	48
3938	Splice link	1	25	11/16	18	2	44		
3939	3 m Flange track/bond*	118 1/16	2999	2 3/8	60	203	5768	10	2925
3940	3 m Flange track/bolt-down*	118 1/16	2999	2 3/8	60	196	5565	10	75
3941	2 m T-Track/high-load*	78 11/16	1999	2 3/8	60	128	3638	10	50
3942	Gate track*	29 1/2	749	2 3/8	60	49	1390	10	75
3943	Top endstop*	1 1/2	38	2 3/8	60	5.64	160	10	33
3944	Double storage track*	19 11/16	500	5 15/32	139	91	2590	10	50

Contact Harken to request lead time. *Available in black or clear anodized.

Trysail Switch System

The Trysail Switch allows the mainsail and trysail to share a single track, greatly reducing weight aloft. This asymmetrical switch installs above the standard system and provides a crossover for trysail cars to utilize the mainsail track. The trysail cars are loaded at deck level and travel past the gooseneck and flaked mainsail onto the mainsail track. Switching of the cars is totally automatic; only trysail cars can travel onto the trysail track, while the mainsail cars pass through to the standard switch and storage tracks.

Track

Use standard Switch system T-Track (see pages 149 and 151).

The track's compound bend wraps around the mast section so cars pass next to the mainsail cars on the storage tracks, past the gooseneck and down to the deck. There crew can safely load the trysail onto the track and raise the sail, leaving the mainsail flaked on the boom.

The compound track bend is determined by installer. Cars must not be under load in curved section.

About Switch T-Track Battcar systems: See feature pages at beginning of this section.



C9494
C9342



3928

C9492
C9493
C9340
C9341
3934
3935



C10539
C10419
3933



The Trysail Switch system integrates with the Switch T-Track Battcar system by sharing a single mast track to reduce weight aloft.

Part No.	Description	Length		Width		Weight		Fasteners	Maximum working load		Fits track
		in	mm	in	mm	oz	g		lb	kg	
26 mm											
C9492	Starboard Trysail Switch*	14 1/2	368	4 25/32	121	27	762	6			HC7466, HC8879
C9493	Port Trysail Switch*	14 1/2	368	4 25/32	121	27	762	6			HC7466, HC8879
C9494	Car body*	2 3/8	60	1 1/32	26	5	143		1001	454	HC7466, HC8879
C10539	Push-button endstop	3 15/16	100	1 1/32	26	3	79	6	435	197	HC7466, HC8879
32 mm											
C9340	Starboard Trysail Switch*	16	406	5 7/8	149	43	1222	8			HC7391, HC8880
C9341	Port Trysail Switch*	16	406	5 7/8	149	43	1222	8			HC7391, HC8880
C9342	Car body*	2 15/16	75	3 1/32	77	11	309		2800	1270	HC7391, HC8880
C10419	Push-button endstop	5 29/32	150	1 17/64	32	4.6	130	8	625	283	HC7391, HC8880
40 mm											
3934	Starboard Trysail Switch*	20	508	7 7/16	189	95	2692	10			3939, 3940, 3941
3935	Port Trysail Switch*	20	508	7 7/16	189	95	2692	10			3939, 3940, 3941
3928	Trysail car*	3 21/32	93	3 21/32	93	14	397		3547	1613	3939, 3940, 3941
3933	Push-button endstop*	5 15/16	150	2 3/8	60	9	269	10			3939, 3940, 3941

Contact Harken to request lead time. *Available in black or clear-anodized.

Battcar Dimensions

HEADBOARD PLATE

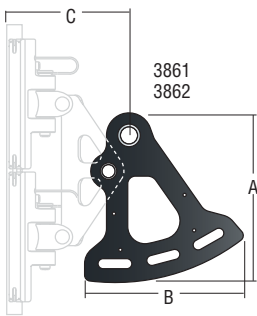

HEADBOARD CAR ASSEMBLY

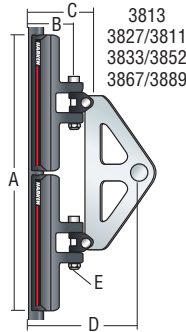

BATTCAR/STUD

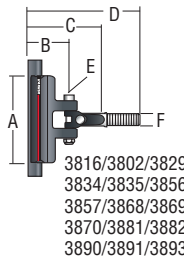

BATTCAR/RECEPTACLE

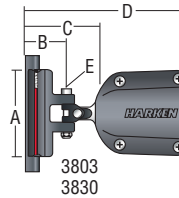

INTERMEDIATE CAR, REEF CAR, UNIVERSAL BATTCAR

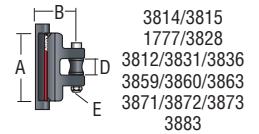

Dimensions (measured from aft face of mast)

Part No.	Description	A		B		C		D		E		F	
		in	mm	in	mm	in	mm	in	mm	in	mm	Stud Ø mm	
System AA CB													
3813	CB headboard car assembly	5 3/16	132	1	25	1 13/16	46					5	
3814	Slider intermediate car	1 3/4	44	15/16	24			3/4	19			5	
3815	CB intermediate car	2 3/16	56	1	25			3/4	19			5	
3816	CB Battcar/10 mm stud	2 3/16	56	1	25	1 13/16	46	3 5/16	84			5	10
System A Slider													
3827	Headboard car assembly	6	153	1 1/16	27	2 1/8	54	3 11/16	94	3/16		5	
1777	Low-load intermediate car	2	51	1 1/8	28			3/4	19	3/16		5	
3828	Intermediate car	1 3/4	44	1 1/16	27			21/32	17	3/16		5	
3802	Battcar/10 mm stud	1 3/4	44	1 1/16	27	2 1/8	54			3/16		5	10
3803	Battcar/40 mm receptacle	1 3/4	44	1 1/16	27	2 1/8	54	5 1/8	130	3/16		5	
System A CB													
3811	Headboard car assembly	8 3/8	213	1 3/8	35	2 1/4, 2 7/8*	57, 73*	4	102	3/16		5	
3889	Headboard car assembly/quick-release	9 1/2	240	1 3/8	35	2 5/8	68	4 5/16	109	1/4		6	
3812	Intermediate car	2 1/4	57	1 3/8	35			3/4	19	3/16		5	
3829	Battcar/10 mm stud	2 7/8	73	1 3/8	35	2 1/4	57	3 11/16	94	3/16		5	10
3830	Battcar/40 mm receptacle	2 7/8	73	1 3/8	35	2 7/8	73	5 3/4	146	3/16		5	
3831	Universal Battcar	2 7/8	73	1 3/8	35			3/4	19	3/16		5	
3881	Battcar/12 mm stud	2 7/8	73	1 3/8	35	2 3/4	69	3 7/8	99	1/4		6	12
3882	Long batten car/12 mm stud	4 1/8	105	1 3/8	35	2 3/4	69	3 7/8	99	1/4		6	12
3883	Reef car	4 1/8	105	1 3/8	35			3/4	19	1/4		6	
System B Slider													
3833	Headboard car assembly	7 1/2	190	1 1/4	32	2 5/16	59	4 5/8	119	1/4		6	
3836	Intermediate car	2 3/16	56	1 1/4	32					1/4		6	
3834	Battcar/10 mm stud	2 3/16	56	1 1/4	32	2 5/16	59	3 9/16	91	1/4		6	10
3835	Battcar/12 mm stud	2 3/16	56	1 1/4	32	2 5/16	59	3 3/4	96	1/4		6	12
System B CB													
3852	Headboard car assembly	10 1/2	267	1 9/16	39	3 1/16	78	4 1/16	102	3/8		10	
3863	Intermediate car	2 9/16	68	1 9/16	39			3/4	19	1/4		6	
3856	Battcar/10 mm stud	4 5/16	109	1 9/16	39	3 1/16	78	4 3/8	111	3/8		10	10
3857	Battcar/12 mm stud	4 5/16	109	1 9/16	39	3 1/16	78	4 3/8	111	3/8		10	12
3859	Universal Battcar	4 1/4	108	1 9/16	39			1	26	3/8		10	
3860	Reef car	5 3/16	132	1 9/16	39			1	26	3/8		10	
3861	Web-on headboard plate	6 13/16	172	6 3/8	161	4 7/8	124						
3862	Web-on headboard plate/flat-top	5 13/16	147	6 3/16	157	5 23/32	145						
3893	Battcar/M12 stud for C-Tech batten	4 1/4	108	1 9/16	39	3	78	4 1/2	114	3/8		10	12
System C CB													
3867	Headboard car assembly	18 5/8	473	2	51	3 5/8	92	5	126	1/2		12	
3871	Intermediate car	3 3/4	95	2	51			1	26	3/8		10	
3868	Battcar/12 mm stud	5 3/8	136	2	51	3 5/8	92	5 1/16	128	1/2		12	12
3869	Battcar/14 mm stud	5 3/8	136	2	51	3 5/8	92	5 1/16	128	1/2		12	14
3870	Battcar/16 mm stud	5 3/8	136	2	51	3 5/8	92	5 1/16	128	1/2		12	16
3872	Universal Battcar	5 3/8	136	2	51			1 5/16	33	1/2		12	
3873	Reef car	9 1/8	231	2	51			1 5/16	33	1/2		12	
3890	Battcar/M12 stud for C-Tech batten	5 3/8	136	2	51	3 5/8	92	5 5/16	135	1/2		12	12
3891	Battcar/M14 stud for C-Tech batten	5 3/8	136	2	51	3 5/8	92	5 5/16	135	1/2		12	14

*Boltrope setback: with car 3829/with car 3830.

Furling Mainsail Outhaul Systems

Use furling outhaul cars with in-mast or behind-the-mast furlers on boats up to 13.5 m (45'). Sheave carriers pivot side-to-side to accommodate changing lead angles. Systems have 2:1 purchase and ride on cars with Torlon® ball bearings. A deadend outhaul shackle is included.

Cars have axle-bearing sheaves.

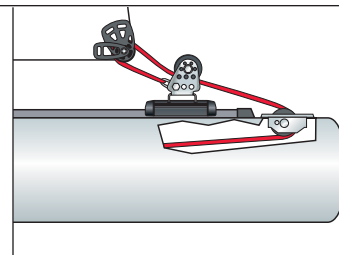

Torlon is a registered trademark of Solvay Advanced Polymers L.L.C.

Part No.	Description	Sheave Ø		Length		Weight		Car width		Maximum working load		Max sail area		Track
		in	mm	in	mm	oz	g	in	mm	lb	kg	ft²	m²	
1648	CB outhaul car	2	51	5 1/4	133	24	680	2 3/4	70	2300	1043	300	28	R27
3076	CB outhaul car	2 1/2	64	5 1/4	133	34	964	3 3/8	85	3000	1361	425	40	R32
3096	CB outhaul car	2 15/16	75	7 1/4	184	62	1758	3 3/8	85	4500	2041	550	51	R32

See page 277 for replacement balls.

Lazy Jacks

Lazy Jacks contain mainsails while reefing and dousing. They work extremely well with full-batten mains, but can also be used with conventional sails.



252
253
254
See "Lazy Jacks" on page 272.

Part No.	Description	Boat length		Boom length		Mainsail luff length	
		ft	m	ft	m	ft	m
252	Small	21 - 28	6.4 - 8.5	7 - 13	2.13 - 3.96	21 - 32	6.4 - 9.75
253	Medium	27 - 37	8.2 - 11.3	10' 6" - 16	3.2 - 4.9	32 - 42	9.75 - 12.8
254	Large	35 - 42	10.7 - 12.8	12 - 16	3.7 - 4.9	35' 7" - 48	10.88 - 14.63

HEADSAIL HANDLING SYSTEMS



Carbo Racing Foil

The engineering resins in these strong, lightweight head foils offer significant advancements over the weaker PVC materials used by other manufacturers. The low-friction twin headsail grooves are ultra-smooth, allowing hoists, douses, and headsail changes to be easily and efficiently executed. Impact resistance is unmatched, with far less foil damage from loaded spinnaker poles, especially in cold weather. Heat has little effect on stiffness.

Foils are UV protected and easy for the trimmer to see. For mast-up installation, simply uncoil the foil and snap onto the stay.

Aluminum Chafe Guard

An aluminum chafe guard keeps spinnaker sheets from damaging the foil during high-speed jibes. Testing shows this guard weighs the same as aramid fiber or composite, and is impervious to wear, unlike UHMW plastic tape which wears away quickly. A Harken chafe guard is included free with the purchase of a 7000, 7001, or 7002 kit.



Invictus, Jeanneau Sun Fast 3600, 11.25 m (36'10"), Daniel Andrieu design © Billy Black



Trim cap



Feeder for smooth hoists:
Funnel-shaped stainless feeder smoothly guides boltrope into headfoil for fast hoists.



Prefeeder: Hardcoat-anodized, PTFE-coated aluminum rollers spin freely on low-friction bushings.

Kit includes prefeeder.



7000
7001
7002

7003



7006

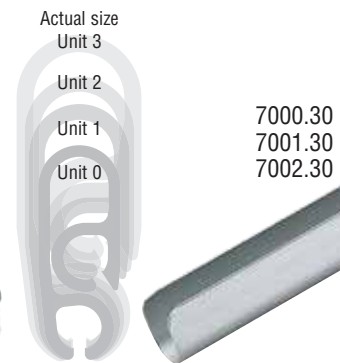

Actual size
Unit 3
Unit 2
Unit 1
Unit 0

7000.30
7001.30
7002.30

Part No.	Description	Max wire Ø		Max rod Ø		Extrusion length		Max headstay length		Spacer tube length		Extrusion weight		Full system weight*		Luff tape size**	
		in	mm	dash	mm	ft/in	m	ft/in	m	ft/in	m	lb/ft	kg/m	lb	kg	in	mm
7000.9M	Unit 0	1/4	6	-10	6.35	29' 6"	9	33' 6"	10.2	3' 3"	1	0.102	0.152	3.29	1.5	#5 (5/32)	4
7000.12M	Unit 0	1/4	6	-10	6.35	39' 4"	12	43' 4"	13.2	3' 3"	1	0.102	0.152	4.29	1.95	#5 (5/32)	4
7000.15M	Unit 0	1/4	6	-10	6.35	49' 2"	15	53' 2"	16.2	3' 3"	1	0.102	0.152	5.3	2.41	#5 (5/32)	4
7001.12M	Unit 1	5/16	8	-17	8.38	39' 4"	12	43' 4"	13.2	3' 3"	1	0.162	0.241	6.99	3.18	#6 (6/32)	5
7001.16M	Unit 1	5/16	8	-17	8.38	52' 6"	16	56' 5"	17.2	3' 3"	1	0.162	0.241	9.13	4.14	#6 (6/32)	5
7001.20M	Unit 1	5/16	8	-17	8.38	65' 7"	20	69' 7"	21.2	3' 3"	1	0.162	0.241	11.25	5.1	#6 (6/32)	5
7002.16M	Unit 2	3/8	10	-25	10.31	52' 6"	16	56' 5"	17.2	3' 3"	1	0.185	0.275	10.43	4.73	#6 (6/32)	5
7002.20M	Unit 2	3/8	10	-25	10.31	65' 7"	20	69' 7"	21.2	3' 3"	1	0.185	0.275	12.9	5.83	#6 (6/32)	5
7002.24M	Unit 2	3/8	10	-25	10.31	78' 9"	24	82' 9"	25.2	3' 3"	1	0.185	0.275	15.29	6.93	#6 (6/32)	5
7003.24M	Unit 3	7/16	11	-30	11.1	78' 9"	24	82' 9"	25.2	3' 3"	1	0.245	0.365	20.08	9.1	#6 (6/32);#7 (7/32)	5;6
7003.28M	Unit 3	7/16	11	-30	11.1	91' 10"	28	95' 9"	29.2	3' 3"	1	0.245	0.365	23.31	10.57	#6 (6/32);#7 (7/32)	5;6
7006	Carbo racing foil prefeeder													3 oz	85 g		
7000.30	Unit 0 chafe guard							3' 3"	1					2.5 oz	70 g		
7001.30	Unit 1 chafe guard							3' 3"	1					2.9 oz	82 g		
7002.30	Unit 2 chafe guard							3' 3"	1					3 oz	85 g		

*Weight without chafe guard. **Nominal dimensions only, actual luff tape dimensions are larger.

Small Boat Furling Components: Underdeck

Underdeck Furlers

Small Boat underdeck furling units are ideal for sportboats and daysailers from 4.8 - 9 m (16 - 30'). The drum is located beneath the deck, lowering the tack height for maximized sail area. The single through-deck ball joint provides a low-profile, nearly watertight system that aligns the spool to the headstay. Like all Small Boat furlers, the underdeck furler is for furling only, not reefing.

An optional hoistable ball bearing halyard swivel can be installed on the headstay so the sail can be raised or lowered without removing the headstay. See page 158.

Tack Adapter Tangs

Stainless steel tack adapter tangs are used to adapt clevis pin diameters on headstays to the standard clevis pin size that comes on the Harken unit. A third hole accepts lashing to adjust jib luff tension.



TACK ADAPTER TANGS

479
480
481
489

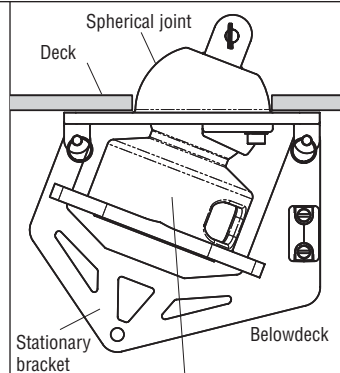

Turnbuckle eye on stationary bracket attaches to an underdeck chainplate.



478



477
493



Fairlead feeds line onto the spool.

UNDERDECK FURLERS

Components (if ordering separately)

Upper swivel Part No.	Hoistable swivel Part No.	Drum Part No.	Weight						Fits furler
			Upper swivel		Hoistable swivel		Drum		
			oz	g	oz	g	oz	g	
164	464	477L	2.6	74	2.9	82	24	680	477
207	465	493L	9.2	261	8.9	252	42.6	1201	493
478U	482	478L	15	431	16.8	477	81	2296	478

Furlers

Part No.	Description	Pin-to-pin length		Drum Ø		Line Ø				Jaw width		Max luff wire Ø		Clevis pin Ø		Weight		Maximum working load	
		in	mm	in	mm	Min	Max	in	mm	in	mm	in	mm	in	mm	oz	g	lb	kg
477	Underdeck furler/small*	6 1/8	156	3 1/8	79	1/8	3	5/32	4	5/16	8	1/8	3	1/4	6.4	23.3	661	950	431
493	Underdeck furler/medium*	7 3/8	188	4	102	5/32	4	3/16	5	3/8	10	3/16	5	5/16	7.9	50.5	1433	2000	907
478	Underdeck furler/large*	10 7/32	260	5	127	3/16	5	1/4	6	1/2	12	1/4	6	7/16	11.1	96	2721	3000	1361

*Includes drum and upper swivel. Does not include hoistable swivel.

Tack Adapter Tangs

Part No.	Description	Tang-hole to tang-hole length		Upper pin Ø		Lower pin Ø		Max luff wire Ø		Clevis pin Ø		Weight		Maximum working load		Fits furler
		in	mm	in	mm	in	mm	in	mm	in	mm	oz	g	lb	kg	
479	4 mm tack adapter tang	1 1/2	38	5/16	8	7/16	11	5/32	4	5/16	7.9	5.2	147	3000	1361	478
480	5 mm tack adapter tang	1 1/2	38	3/8	10	7/16	11	3/16	5	3/8	9.5	5.2	147	3000	1361	478
481	6 mm tack adapter tang	1 1/2	38	7/16	11	7/16	11	1/4	6	7/16	11.1	5.2	147	3000	1361	478
489	8 mm tack adapter tang	1 3/8	35	5/16	8	5/16	8	5/32	4	5/16	7.9	3.2	91	2000	907	493

Small Boat Furling Components: Halyard Swivels

All Harken Small Boat furling components can be purchased individually to mix and match. Systems require a drum and upper swivel. Some are also available as a complete kit. See page 159 for details.

Small Boat units are for furling only, not reefing.

Upper Halyard Swivels

Harken's high-performance 207HP swivel has needle roller thrust bearings that function smoothly under very high loads required at the top end of sportboat fleets, while matching the dimensions of our other 207 units—making an upgrade easy.

Standard upper halyard swivels feature multiple stacked races of ball bearings for low friction rotation under load. Delrin® ball bearings are used for low-load swivels. Torlon® bearings are used in standard and high-load swivels. Shackle or forked tang attachment options are available.

Hoistable Halyard Swivels

An optional hoistable ball bearing halyard swivel can be installed on the headstay so the sail can be raised or lowered without removing the headstay. Swivels are independent of the headstay, which allows the luff to be tensioned separately from the mast rake. Hoistable swivels work along with any standard Harken Small Boat furler.



Multiple stacked races of Delrin or Torlon ball bearings roll easily under load.

System with hoistable swivel: furling headsail can be raised/lowered

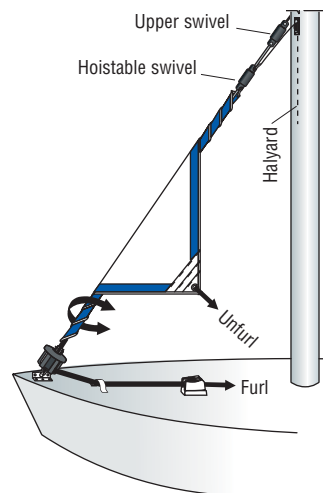

System without hoistable swivel: furling headsail remains on stay

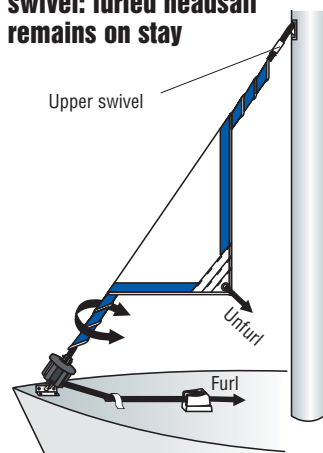

Delrin is a registered trademark of E. I. du Pont de Nemours and Company or its affiliates. Torlon is a registered trademark of Solvay Advanced Polymers L.L.C.



UPPER HALYARD SWIVELS

HOISTABLE SWIVELS

Part No.	Description	Pin-to-pin length		Max luff wire Ø		Clevis pin Ø		Weight		Maximum working load		Use with drum
		in	mm	in	mm	in	mm	oz	g	lb	kg	
Upper Halyard Swivels												
162	Low-load upper swivel	2 1/2	64	1/8	3	1/4	6.4	2.6	74	500	227	163
164	Standard upper swivel	2 1/2	64	1/8	3	1/4	6.4	2.6	74	950	431	165, 477L, 1134
207	High-load upper swivel	3 27/32	97.4	3/16	5	5/16	8	9.2	261	2000	907	208, 493L
207HP	High-performance upper swivel	3 27/32	97.4	3/16	5	5/16	8	6.8	193	2000	907	208, 493L
1878	Standard upper swivel/shackle	2 1/2	64	1/8	3	1/4	6.4	2.7	77	950	431	165, 477L, 1134
1880	High-load upper swivel/shackle	4	102	3/16	5	5/16	8	9.3	264	2000	907	208, 493L
Hoistable Halyard Swivels												
464	Halyard swivel/hole for 4 mm wire	4 3/16*	124*	5/32	4	5/32	4	2.9	82	810	367	435, 477L
465	Halyard swivel/hole for 5 mm wire	5 11/16*	144*	3/16	5	3/16	5	8.9	252	1190	540	208, 493L, 1134
482	Halyard swivel/hole for 6 mm wire	7 19/32*	193*	1/4	6	1/4	6.4	16.8	477	3000	1361	478L

*Shackle-to-shackle.

Small Boat Furling Components: Drums

All Harken Small Boat furling components can be purchased individually to mix and match. Systems require a drum and upper swivel. See page 158 for swivels. Some systems also available as a complete kit (see below).

Conventional Furling Drums

Harken Small Boat furling systems allow the trailerable cruising or dinghy sailor to set and furl the jib from the cockpit. Drums feature multiple stacked races of Delrin® or Torlon® bearings for smooth rotation under load. Small Boat units are for furling only, not reefing.

Continuous Line-Drive Furling Drum

The continuous line-drive furler is the perfect solution for high-performance skiffs and dinghies that use oversized jibs/gennakers and for staysails on larger boats. Unlike conventional furling drums, the low-profile line-driver never runs out of line, and can completely furl any sized sail. Offset holes in the drive sheave grip line securely, with the stripper arm and feeder working together to prevent line from jamming. The line guard adjusts in 90-degree increments to accommodate attachments to the boat.

Delrin is a registered trademark of E. I. du Pont de Nemours and Company or its affiliates.
Torlon is a registered trademark of Solvay Advanced Polymers L.L.C.



Continuous line-drive furler features offset holes in the drive sheave to grip line securely.



Part No.	Description	Pin-to-pin length		Drum Ø		Line Ø		Jaw width		Max luff wire Ø		Clevis pin Ø		Weight		Maximum working load		Upper swivel
		in	mm	in	mm	in	mm	in	mm	in	mm	in	mm	oz	g	lb	kg	
163	Low-load furler	2 1/2	64	2 7/8	73	5/32	4	5/16	8	1/8	3	1/4	6.4	5	142	500	227	162
165	Standard furler	2 1/2	64	2 7/8	73	5/32	4	5/16	8	1/8	3	1/4	6.4	5	142	950	431	164
208	High-load furler	4	102	4 3/16	106	1/4	6	3/8	10	3/16	5	5/16	7.9	13.6	386	2000	907	207
1134	Continuous line-drive furler	2 11/16	68	2 7/8	73	3/16	5	5/16	8	1/8	3	1/4	6.4	5.4	154	950	431	164

Small Boat Furling Kits

Harken Small Boat furling systems allow the trailerable cruising or dinghy sailor to set and furl the jib from the cockpit. Small Boat units are for furling only, not reefing.

All kits include the drum and upper swivel. The 483 kit also includes a hoistable halyard swivel. To order components separately, see swivels page 158, drums above.



Part No.	Description	Fits boats				Upper swivel	Includes Hoistable swivel	Drum	Weight		Maximum working load	
		Monohull		Catamaran					oz	g	lb	kg
		ft	m	ft	m							
434	Low-load kit	Under 16	Under 4.9			162		163	7.6	215	500	227
435	Standard kit	16 - 20	4.9 - 6.1	to 18	to 5.5	164		165	7.6	215	950	431
436	High-load kit	20 - 25	6.1 - 7.6	18 - 23	5.5 - 7	207		208	22.8	646	2000	907
483	Standard kit/hoistable halyard	16 - 20	4.9 - 6.1	to 18	to 5.5	164	464	165	11.2	318	950	431

For additional specifications, see corresponding drum part number.



Polar Bear, 8.36 m (27.43'), Chantier des Ilesaux, naval architect: Paolo Bua © Valerie Lanata

REFLEX FURLING

In a quickly-evolving environment, the Harken Reflex furling system is pushing free-flying sail furling forward. The patented Reflex system provides sailors confidence that their free-flying asymmetrical spinnakers, gennakers, and code sails will furl completely with speed and control. Pull the furling line and the compact drive unit reacts reflexively to rotate the torsion cable, immediately transferring torque to the head. The head swivel reacts instantly, spinning from top to bottom where perfect furls must start. Reflex furling requires much less luff tension to transfer torque than earlier technology, making it the perfect solution for today's budding cable-less code sail technology which requires about half the luff loads previously required. And whether the Reflex torsion cable is specified, or in applications where the head swivel and a tack plate are sewn directly to the sail, Reflex furling's quick release geometry allows crews to use multiple sails with the same bottom unit.

Three sizes:

Unit 1 is rated at 1.5T MWL for boats to 11 m (36').

Unit 2 is rated at 2.5T MWL for boats up to 14 m (45').

Unit 3 is rated at 4.5T MWL for boats up to 17.4 m (58').



Unit 1: 7351.10
Unit 2: 7352.10
Unit 3: 7353.10

Complete even roll-up, tight wrap

- Low-friction ball bearing tack swivel allows the upper part of the sail to furl first.

Strong, lightweight

- Large diameter hardcoat-anodized 6061-T6 aluminum drive sheave.
- Torlon® ball bearings reduce friction, simplify maintenance.

Holds line securely

- Flexible polycarbonate alloy cowling allows rope to be easily fed into drive sheave without tools; keeps rope captive.
- Offset holes in drive sheave grip rope securely when furling.
- Stripper and feeder work together to prevent furling line from jamming.



Torlon is a registered trademark of Solvay Advanced Polymers L.L.C.

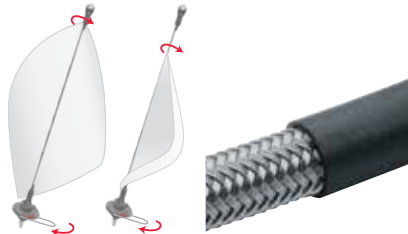

Code Zero sails

- The quick-release T-fitting allows the bottom unit to handle both code zero and asymmetric sails.
- The fixed tack terminal option is used when the torsion cable is inside the luff. A 2:1 soft attach is recommended for increased purchase and luff tension.

Immediate, smooth, controlled furling

- Reflex cable is more torsionally resistant to corkscrewing than the current breed of textile cable.
- All Reflex furlers use braided stainless steel wire filaments over braided textile core to transmit torque to the head swivel for faster furling. Unit 3 furlers use a Dyneema® core, which twists less and handles increased halyard loads without stretching, making them well suited for code zero applications by eliminating need for additional luff cable.
- Smooth polymer cable jacket protects sails against abrasion.

Easily change furled spinnakers

- Quick-release modular T-fitting allows single drive unit to handle multiple sails.
- Each sail has its own torsion cable. Head and tack swivels are permanently fitted to each sail.
- Rolled sail easily disconnects with the pull of one spring-loaded pin; new furled sail slides and locks into T-slot.



Padded cover



Lightweight, low-profile head swivel

- Integral thimble/terminal for torsion cable saves weight; no fork, eye, or pin connections.
- Compact design reduces weight aloft, maximizes luff length.
- Padded cover prevents damage to spars.

Reflex for retrofit

- Both head and tack swivels are available with fork and pin interfaces to allow sails with existing torsion cables finished with eyes to be easily adapted to Reflex furling. Contact Harken for details.

Reflex for cable-less Code sails

- Reflex head swivels and tack plates with integral T-fittings can be sewn directly to today's cable-less sails. The compact solution allows for longer luff lengths. Plus the same drive unit can service the whole inventory. Contact Harken for details.

Ordering Asymmetric Reflex Furling

Use for asymmetric free-flying spinnakers, cruising spinnakers, and gennakers that have a loose positive luff that is longer than the leech.

Boat Requirements

1. Spinnaker halyard
2. Attachment bail or adjustable tack fitting on a bowsprit or bow extension that allows the furler to clear the forestay and bow pulpit.

1. Determine System Size

Refer to "Typical Boat Length" and "Maximum Sail Area" on unit pages to select the correct size. Note: if you plan to use the system for code zero sails, the loads will be higher so the maximum boat length and sail area are smaller.

2. System Components

The Reflex furling system for asymmetric spinnakers includes all components necessary for one asymmetric spinnaker: one drive unit with snap shackle attachment, tack swivel, head swivel, torsion cable, set of cable clamps.

For each additional sail, order these components separately so you can easily switch furled sails using the quick-release T-slot: one tack swivel, head swivel, Reflex torsion cable, and set of cable clamps.

3. Determine Reflex Torsion Cable Length

Each system includes a length of torsion cable. To purchase the correct system including the right length of cable, determine your Full Hoist Dimension (FH). To do so, measure the distance between the sail attachment points at the top of the rig and the bow fitting or fully-extended bowsprit. Make sure the kit you select includes more cable than your FH measurement.

4. Attachment to Boat

The standard Reflex furling system for asymmetric spinnakers includes a threaded snap shackle adapter. To change to D shackle or soft-attach 2:1 adjuster see chart at right.

5. Ordering Furling Line

The Reflex furling system requires continuous furling line. Talk to your rigger about furling line construction using a structural cover over a nonstructural core. Note: have the rigger capture the aft block in the loop before splicing. The furling line loop can load into stanchion leads and drive unit after it is spliced.

Refer to chart below for line size and length. Double the loop length and add enough length for the overlap in the end-for-end splice.

Standard kit includes

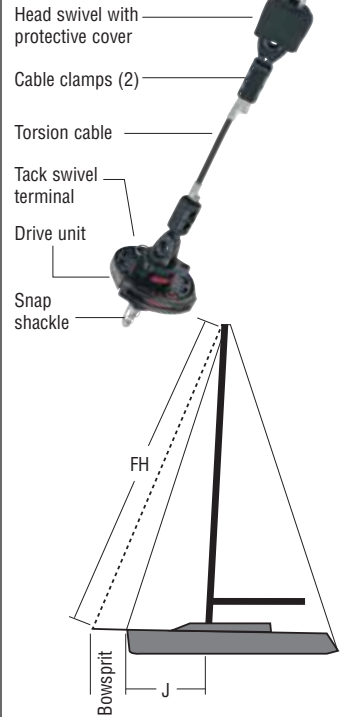

Alternative Attachments to Boat

Unit	High-resistance D shackle	Soft-attach 2:1 adapter
1	7351.21	7351.22
2	7352.21	7352.22
3	7353.21	7353.55

Furling Line

Unit	Line Ø		Length of loop (cruisers)	Length of loop (racers)
	in	mm		
1	1/4	6	Measure from furler to aft lead block in cockpit	Use J dimension plus length of bowsprit minus 60 cm (2')
2	5/16	8		
3	3/8	10		

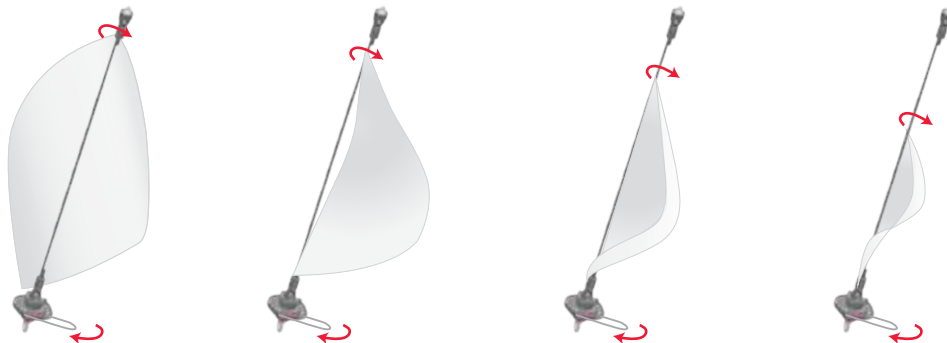

Reflex Furling System Unit 1

For Asymmetric Spinnakers

Typical Boat Length 7.5 - 11 m (25' - 36')

Maximum Sail Area 112 m² (1200 ft²)

Part No.	Description
7351.10.16M	Furling system with 16.15 m (53') cable*
7351.10.18M	Furling system with 18.29 m (60') cable*
7351.10.20M	Furling system with 20.12 m (66') cable*

Optional Parts

7351.21	D-shackle threaded adapter
7351.22	2:1/soft attachment threaded adapter
7351.26	Reflex tack swivel terminal for extra sails
7351.28	Head swivel for extra sails
7351.37	Forked head swivel for retrofit torsion cable
7351.39	Reflex forked tack swivel terminal for retrofit torsion cable
7371.SPOOL	Reflex torsion cable (spool) 8 mm x 305 m (5/16" x 1000')
7371	Reflex torsion cable (ordered by the foot) for extra sails
7357	Cable clamp (set of 2) for extra sails
7356	Lead block kit**
7355	Outboard fairlead

*Includes: drive unit, head swivel, Reflex tack swivel terminal, snap shackle threaded adapter, Reflex torsion cable, and clamps. **Fairlead kit includes 2 fairleads, fairlead with cleat, and aft block.

Reflex Furling System Unit 2

For Asymmetric Spinnakers

Typical Boat Length 10 - 14 m (34' - 45')

Maximum Sail Area 168 m² (1800 ft²)

Part No.	Description
7352.10.20M	Furling system with 20.12 m (66') cable*
7352.10.23M	Furling system with 22.87 m (75') cable*
7352.10.25M	Furling system with 25 m (82') cable*

Optional Parts

7352.21	D-shackle threaded adapter
7352.22	2:1/soft attachment threaded adapter
7352.26	Reflex tack swivel terminal for extra sails
7352.28	Head swivel for extra sails
7352.37	Forked head swivel for retrofit torsion cable
7352.39	Reflex forked tack swivel terminal for retrofit torsion cable
7372.SPOOL	Reflex torsion cable (spool) 10 mm x 305 m (3/8" x 1000')
7372	Reflex torsion cable (ordered by the foot) for extra sails
7358	Cable clamp (set of 2) for extra sails
7356	Lead block kit**
7355	Outboard fairlead

*Includes: drive unit, head swivel, Reflex tack swivel terminal, snap shackle threaded adapter, Reflex torsion cable, and clamps. **Fairlead kit includes 2 fairleads, fairlead with cleat, and aft block.



7351.10
7352.10

Optional Parts



7351.28
7352.28

7351.37
7352.37



7351.26
7352.26

7351.39
7352.39



7351.21
7352.21



7351.22
7352.22

7357
7358



7371
7372

7371.SPOOL
7372.SPOOL



7355

7356



Ordering Code Zero Reflex Furling

The Reflex torsion cable is not designed to accept luff loads associated with earlier code sail technology. It does, however, transfer the necessary torque to the head swivel for complete furling twice as effectively as any system we have tested—at far lower loads. If high luff loads will be encountered, combine a tension handling line with the Reflex torsion cable.

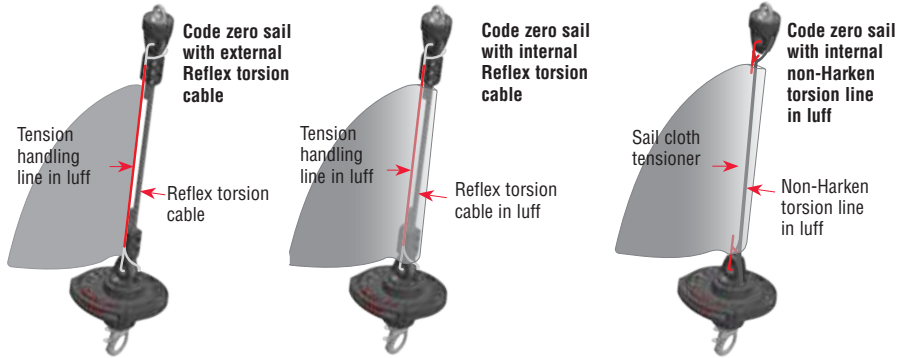

To furl a code zero sail that has a non-Harken torsion cable sewn into the luff, use either the thimbles or the eyes to secure to the head swivel and fixed tack terminal.



7361.10
7362.10



Includes 2:1 threaded adapter for attachment to bowsprit.

Optional Parts



7351.28
7352.28

7351.37
7352.37



7351.27
7352.27

7351.38
7352.38



7351.20
7352.20

7358

7351.21
7352.21

Reflex Furling System Unit 1

For Code Zero Sails

Typical Boat Length 6.7 - 10 m (22' - 32')

Maximum Sail Area 60 m² (650 ft²)

Part No.	Description
7361.10	Code zero furling system*
Optional Parts	
7351.20	Snap shackle threaded adapter
7351.21	D-shackle threaded adapter
7351.27	Reflex fixed tack terminal for extra sails
7351.28	Head swivel for extra sails
7351.37	Forked head swivel for retrofit torsion cable
7351.38	Reflex forked tack terminal for retrofit torsion cable
7371.SPOOL**	Reflex torsion cable (spool) 8 mm x 305 m (5/16" x 1000')
7371**	Reflex torsion cable (ordered by the foot) for extra sails
7357**	Cable clamp (set of 2) for extra sails

*Includes: drive unit, head swivel, Reflex fixed tack terminal, 2:1 threaded adapter.

**Order Reflex torsion cable and clamp set for 7361.10 to improve furling.

Reflex Furling System Unit 2

For Code Zero Sails

Typical Boat Length 9 - 12 m (30' - 40')

Maximum Sail Area 84 m² (900 ft²)

Part No.	Description
7362.10	Code zero furling system*
Optional Parts	
7352.20	Snap shackle threaded adapter
7352.21	D-shackle threaded adapter
7352.27	Reflex fixed tack terminal for extra sails
7352.28	Head swivel for extra sails
7352.37	Forked head swivel for retrofit torsion cable
7352.38	Reflex forked tack terminal for retrofit torsion cable
7372.SPOOL**	Reflex torsion cable (spool) 10 mm x 305 m (3/8" x 1000')
7372**	Reflex torsion cable (ordered by the foot) for extra sails
7358**	Cable clamp (set of 2) for extra sails

*Includes: drive unit, head swivel, Reflex fixed tack terminal, 2:1 threaded adapter.

**Order Reflex torsion cable and clamp set for 7362.10 to improve furling.



7371
7372

7371.SPOOL
7372.SPOOL

Reflex Furling System Unit 3

For Asymmetric Spinnakers

Typical Monohull Length 13 - 17.7 m (44' - 58')

Typical Multihull Length 12 - 16.7 m (39' - 55')

Maximum Sail Area 223 m² (2400 ft²)

Part No.	Description
7353.10.22M	Furling system with 21.95 m (72') cable*
7353.10.26M	Furling system with 25.91 m (85') cable*

Optional Parts

7353.21	D-shackle threaded adapter
7353.22	3:1/soft attachment threaded adapter
7353.26	Reflex tack swivel terminal for extra sails
7353.28	Head swivel for extra sails
7353.37	Forked head swivel for retrofit torsion cable
7353.39	Reflex forked tack swivel terminal for retrofit torsion cable
7373.SP00L	Reflex torsion cable (spool) 13 mm x 305 m (33/64" x 1000')
7373	Reflex torsion cable (ordered by the foot) for extra sails
7367	Cable clamp (set of 2) for extra sails

*Includes: drive unit, head swivel, Reflex tack swivel terminal, snap shackle threaded adapter, Reflex torsion cable, and clamps.

Reflex Furling System Unit 3

For Code Zero Sails

Typical Monohull Length 12 - 16.5 m (39' - 54')

Typical Multihull Length 11 - 15 m (36' - 50')

Maximum Sail Area: Monohull 158 m² (1700 ft²); Multihull 139 m² (1500 ft²)

Part No.	Description
7363.10	Code zero furling system*

Optional Parts

7353.20	Snap shackle threaded adapter
7353.21	D-shackle threaded adapter
7353.27	Reflex fixed tack terminal for extra sails
7353.28	Head swivel for extra sails
7353.37	Forked head swivel for retrofit torsion cable
7353.38	Reflex forked tack terminal for retrofit torsion cable
7373.SP00L**	Reflex torsion cable (spool) 13 mm x 305 m (33/64" x 1000')
7373**	Reflex torsion cable (ordered by the foot) for extra sails
7367**	Cable clamp (set of 2) for extra sails

*Includes: drive unit, head swivel, Reflex fixed tack terminal, 3:1 threaded adapter.

**Order Reflex torsion cable and clamp set for 7363.10 to improve furling.



Optional Parts



7353.28



7353.37



7353.26



7353.27



7353.39



7353.38



7353.20



7353.21



7353.22



7367



7373

7373.SP00L

Ordering Jib Reefing & Furling

1. Choose Furler Type

The table below is based on sailing style and approximate boat size.

This table is only a guideline. Do not use it to determine unit size.

Size is based on the headstay and clevis pin diameters listed on unit pages.

Comparison Chart

	MKIV Racers/performance cruisers	ESP Cruisers
Note: Typical boat lengths are listed as a guideline but are not the determining factor. Check with Harken if your length varies.		
Typical boat lengths	Unit 0: 6.5 – 9.1 m (22 – 30') Unit 1: 8.5 – 11 m (28 – 36') Unit 2: 10 – 14.2 m (35 – 46') Unit 3: 13.7 – 18.3 m (45 – 60') Unit 4: 19.8 – 24.4 m (65 – 80')	Unit 0: 6 – 8.5 m (20 – 28') Unit 1: 8 – 10.7 m (26 – 35') Unit 2: 10.4 – 14 m (34 – 46') Unit 3: 13.7 – 18.6 m (45 – 61')
Foils	Double-groove Air foil Stainless steel feeder	Single-groove round foil Stainless steel feeder
Halyard and tack swivel	Independent swivels for improved sail shape	Fixed
Drum	Removable split drum for racing	Fixed
Line	Included on Units 0, 1, 2	Not included

2. Determine Unit Size

Size is based on the headstay and clevis pin diameters listed on unit pages.

Choose between unit sizes when diameters are shared by considering stay length and typical boat size recommendations. Contact Harken if you have any questions.

3. Determine if Additional Foils Needed

Use the I and J measurements to determine the length of the headstay. If the existing headstay is longer than the standard length listed under Headstay Length on unit pages, order additional foils and connectors. In some cases one or two extra foils and connectors may be necessary.

4. Determine Toggle, Link Plate, or Leg Kit

Use short toggle (MKIV) or short leg kits (ESP) for maximum luff length. For ESP, use long or medium leg kits to accommodate a turnbuckle or to clear an anchor.

5. Choose Lead Block Kit and Accessories, ESP - Order Line

Harken recommends equipping every furling system with a ratchet lead block kit. Other parts on the **Furling Accessories** page (189 - 190) include equipment for halyard management and racing hardware for faster sail changes. Order line for ESP furlers.

6. Prepare Sail and Headstay

Have a luff tape added to your genoa. Match the sail length to the stay length minus the height of the halyard swivel and lower unit. See sizing information on page 183.

All MKIV and those ESP furlers with long or medium leg kits install over the existing turnbuckle. The turnbuckle is accessible for adjustment by raising the drum. See the **MKIV & ESP Toggle & Rigging Options** on page 167 to determine toggle and rigging requirements. Some headstays will require cutting and shortening to fit Harken toggle. Sometimes only the lower threaded turnbuckle fitting needs changing. Check with a professional rigger on stay condition before reusing stay.

For all units, rod rigging requires a Harken rod adapter stud. It must be cut and coldheaded by an authorized rod service center.

7. Contact

If you have questions, please contact your dealer or Harken Technical Service.

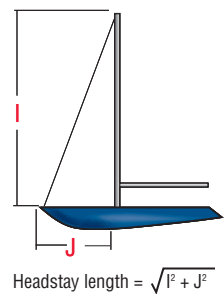
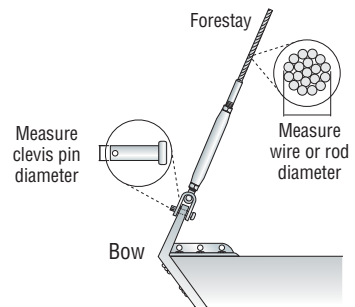

Toggle & Rigging Options

Use these rigger-supplied options to fit Harken toggles and leg kits shown below. Harken toggle and leg kit assemblies sold separately. See unit pages.

Model	Toggle Part No.	Description	Clevis Pin Ø		Fits Unit	Furler Part No.
			in	mm		
MKIV	7311.20 1/2	Jaw/jaw	1/2	12.7	1	7411.10
	7311.21 1/2	Long link plate w/toggle	1/2	12.7		
	7311.21 5/8	Long link plate w/toggle	5/8	15.9		
	7312.20 5/8	Jaw/jaw	5/8	15.9	2	7412.10
	7312.21 5/8	Long link plate w/toggle	5/8	15.9		
	7312.21 3/4	Long link plate w/toggle	3/4	19.1		
	7413.20 3/4	Jaw/jaw w/short link plate	3/4	19.1	3	7413.10
	7413.20 7/8	Jaw/jaw w/short link plate	7/8	22.2		
	7313.21 3/4	Long link plate w/toggle	3/4	19.1		
	7313.21 7/8	Long link plate w/toggle	7/8	22.2	4	7414.10
7414.20 7/8	Jaw/jaw w/short link plate	7/8	22.2			
7414.20 1	Jaw/jaw w/short link plate	1	25.4			
7414.20 1 1/8	Jaw/jaw w/short link plate	1 1/8	28.6			

MKIV	7410.20 5/16	Eye/jaw (reversible)	5/16	7.9	0	7410.10
	7410.20 3/8	Eye/jaw (reversible)	3/8	9.5		
	7410.20 7/16	Eye/jaw (reversible)	7/16	11.1		
	7411.20 1/2	Eye/jaw (reversible)	1/2	12.7	1	7411.10
	7412.20 5/8	Eye/jaw (reversible)	5/8	15.9	2	7412.10
	7311.20 5/8	Stud/jaw*	5/8	15.9	1	7411.10
7312.20 3/4	Stud/jaw**	3/4	19.1	2	7412.10	

*Thread Ø: 5/8–18 LH **Thread Ø: 3/4–16 LH

Toggle flips for alternate chainplate position.

MKIV	ELECTRIC	7312.22 5/8	Jaw/jaw w/link plate	5/8	15.9	2E	7312.13 12V/24V
		7413.22 3/4	Jaw/jaw w/link plate	3/4	19.1		
	HYDRAULIC	7413.22 3/4	Jaw/jaw w/link plate	3/4	19.1	3E	7413.13 12V/24V
		7413.22 7/8	Jaw/jaw w/link plate	7/8	22.2		
		741X.25 X/X	Hydraulic furling toggles	3/4–2 7/16	19.1–61.9	3H - 8H	741X.15
		741X.26 X/X	Furling toggles and cylinders	3/4–2 7/16	19.1–61.9		

ESP	7320.20 5/16	Short leg kit*	5/16	7.9	0	7320.10
	7320.20 3/8	Short leg kit*	3/8	9.5		
	7320.21 5/16	Long leg kit	5/16	7.9		
	7320.21 3/8	Long leg kit	3/8	9.5		
	7321.20 7/16	Short leg kit*	7/16	11.1	1	7321.10
	7321.20 1/2	Short leg kit*	1/2	12.7		
	7321.22 7/16	Medium leg kit**	7/16	11.1		
	7321.22 1/2	Medium leg kit**	1/2	12.7		
	7321.21 7/16	Long leg kit	7/16	11.1	2	7322.10
	7321.21 1/2	Long leg kit	1/2	12.7		
	7322.20 5/8	Short leg kit*	5/8	15.9		
	7322.20 3/4	Short leg kit*	3/4	19.1		
	7322.22 5/8	Medium leg kit**	5/8	15.9	3	7323.10
	7322.22 3/4	Medium leg kit**	3/4	19.1		
7322.21 5/8	Long leg kit	5/8	15.9			
7322.21 3/4	Long leg kit	3/4	19.1			
7323.20 7/8	Short leg kit*	7/8	22.2	3	7323.10	
7323.20 1	Short leg kit*	1	25.4			
7323.22 7/8	Medium leg kit**	7/8	22.2			
7323.22 1	Medium leg kit**	1	25.4			
7323.21 7/8	Long leg kit	7/8	22.2			
7323.21 1	Long leg kit	1	25.4			

*Marine eye only. Does not fit turnbuckle. **Check maximum turnbuckle length for medium leg kit. See unit pages 178-179.

Rigger Supplied

Harken

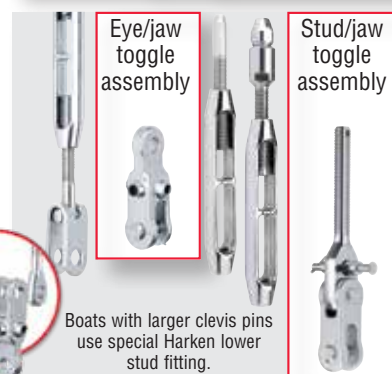

Boats with larger clevis pins use special Harken lower stud fitting.





MKIV JIB REEFING & FURLING

Nothing beats the MKIV Jib Reefing & Furling line for effortless headsail control and great sail shape for optimal speed. With its ability to reef, simply furl and unfurl instead of changing sails to suit conditions, reduce speed, or gain visibility off the bow. Split drum removes for racing. Five sizes fit boats from 6.5 - 24.4 m (22' - 80').



Low-friction efficiency for easy furling and reefing

- Multiple rows of Torlon® ball bearings in high-load areas minimize friction.
- Stacked bearing races evenly distribute radial and thrust loads; drum and halyard swivel turn freely under load.
- Foils rotate around headstay so headstay load is isolated from the furling unit for easy furling.
- Large inner spool diameter increases mechanical advantage for powerful reefing and furling.

Stands up to sun, salt, and time

- Aluminum line guard, torque tube, and swivels deep-saturation hardcoat-anodized, UV-stabilized for durability.
- Line guard polyurethane-coated for wear protection.
- Specially formulated low-stretch black line is abrasion and UV-resistant; standard on units 0, 1, 2.
- Aerodynamic, clear-anodized aluminum Air foils handle extreme reefing loads.
- Triple-interlock foil joints withstand years of torque loading; foil connectors geometric shape interlocks with foil; secures with syringe-injected adhesive; screws provide final lock.

Foil joints



DO NOT use Harken equipment for human suspension unless product is specifically certified and labeled for such use.



Improved sail shape and boat control

- Independent halyard and tack swivels furl sail center before head and tack for improved sail shape when reefed.
- Lightweight aluminum halyard swivel saves weight aloft to reduce pitching and heeling.



Split drum removes easily for racing

- Line guard and spool remove easily for use with full-hoist sails.



Fast hoists, douses, reefs, and sail changes

- Precision-extruded, double-groove Air foils for smooth sail handling and fast sail changes.
- Stainless steel feeder allows fast singlehanded hoist and sail changes.



Designed for easy installation

- Small outside drum dimension fits narrow bows or belowdeck.
- C-shaped open connectors with low-friction plastic isolators easily slip onto headstay wire and into foil.
- Drum assembly fits over existing turnbuckle allowing easy length adjustment. Harken toggle assembly accepts standard turnbuckle using swage, rod, Norseman, or STA-LOK® terminals.
- Eye-jaw toggle flips for fork or tang chainplate installation.

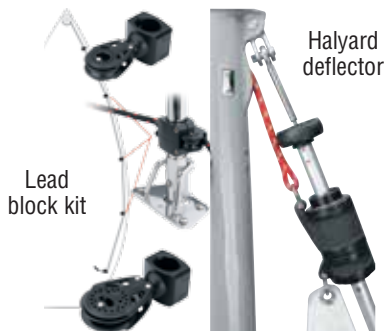

Accessories

- Lead block kit: Easy-to-mount ball bearing blocks lead line aft; fit 25 mm (1") stanchions.
- Halyard deflector: Install above the foil to prevent halyards from wrapping around the foil when furling.



Easy to maintain

- Bearings require no lubrication or isolating seals.
- Stainless steel link plates raise the drum and fit over existing turnbuckle, resist scratches, and can be easily repolished.



MKIV Unit 0 Typical Boat Length 6.5 - 9.1 m (22' - 30')

Wire Ø (1 x 19 SS)	Rod Ø	Clevis pin Ø
4, 5, 6 mm (5/32", 3/16", 7/32")	-4, -6 (4.37, 5.03 mm)	7.9, 9.5, 11.1 mm (5/16", 3/8", 7/16")

Headstay Length Standard 11.77 m (38'7"); max 13.9 m (45'7")

Part No.	Description
7410.10	Furling system

Toggle Assembly Required - sold separately

7410.20 5/16	Eye/jaw reversible toggle assembly with 7.9 mm (5/16") clevis pin
7410.20 3/8	Eye/jaw reversible toggle assembly with 9.5 mm (3/8") clevis pin
7410.20 7/16	Eye/jaw reversible toggle assembly with 11.1 mm (7/16") clevis pin

Optional Parts

7410.30	Extra 2.13 m (7') luff foil extrusion
7410.31	Extra 165 mm (6 1/2") connector with bushings
7420 -4	-4 rod adaptor stud (thread Ø UNF 7/16")*
7421 -6	-6 rod adaptor stud (thread Ø UNF 7/16")*

*Use with conventional turnbuckle.

MKIV Unit 1 Typical Boat Length 8.3 - 11 m (28' - 36')

Wire Ø (1 x 19 SS)	Rod Ø	Clevis pin Ø
6, 7, 8 mm (1/4", 9/32", 5/16")	-8, -10, -12 (5.72, 6.35, 7.14 mm)	12.7, 15.9 mm (1/2", 5/8")

Headstay Length Standard 13.99 m (45'11"); max 16.12 m (52'11")

Part No.	Description
7411.10	Furling system

Toggle Assembly Required - sold separately

7411.20 1/2	Eye/jaw reversible toggle assembly with 12.7 mm (1/2") clevis pin
7311.20 1/2	Jaw/jaw toggle assembly with 12.7 mm (1/2") clevis pin
7311.20 5/8	Stud/jaw toggle assembly with 15.9 mm (5/8") clevis pin (thread Ø UNF 5/8" LH)
7311.21 1/2	Long link plate with toggle assembly with 12.7 mm (1/2") clevis pin
7311.21 5/8	Long link plate with toggle assembly with 15.9 mm (5/8") clevis pin

Optional Parts

7411.30	Extra 2.13 m (7') luff foil extrusion
7411.31	Extra 178 mm (7") connector with bushings
7422 -8	-8 rod adaptor stud (thread Ø UNF 1/2")*
7423 -10	-10 rod adaptor stud (thread Ø UNF 1/2")*
7424 -12	-12 rod adaptor stud (thread Ø UNF 5/8")*

*Use with conventional turnbuckle.

7410.30
7411.30



7410.31
7411.31

7420 -4
7421 -6
7422 -8
7423 -10
7424 -12



7410.20 5/16
7410.20 3/8
7410.20 7/16
7411.20 1/2



7311.20 1/2



7311.20 5/8



7311.21 1/2
7311.21 5/8



Pilgrim, WallyNano MKII, 11.35 m (37.2'), Wally / Hoek Design Naval Architects, Doornernik Yachts BV © Nico Martinez

MKIV Unit 2 Typical Boat Length 10.6 - 14.2 m (35' - 46')

Wire Ø (1 x 19 SS)	Rod Ø	Clevis pin Ø
8, 10 mm (5/16", 3/8")	-12, -17, -22 (7.14, 8.38, 9.53 mm)	15.9, 19.1 mm (5/8", 3/4")
Headstay Length	Standard 18.38 m (60'4"); max 20.51 m (67'4")	
Part No.	Description	
7412.10	Furling system	
Toggle Assembly Required - sold separately		
7412.20 5/8	Eye/jaw reversible toggle assembly with 15.9 mm (5/8") clevis pin	
7312.20 5/8	Jaw/jaw toggle assembly with 15.9 mm (5/8") clevis pin (thread Ø UNF 5/8" LH)	
7312.20 3/4	Stud/jaw toggle assembly with 19.1 mm (3/4") clevis pin (thread Ø UNF 3/4" LH)	
7312.21 5/8	Long link plate with toggle with 15.9 mm (5/8") clevis pin	
7312.21 3/4	Long link plate with toggle with 19.1 mm (3/4") clevis pin	
Optional Parts		
7412.30	Extra 2.13 m (7') luff foil extrusion	
7412.31	Extra 229 mm (9") connector with bushings	
7424 -12	-12 rod adaptor stud (thread Ø UNF 5/8")*	
7425 -17	-17 rod adaptor stud (thread Ø UNF 5/8")*	
7426 -22	-22 rod adaptor stud (thread Ø UNF 3/4")*	

*Use with conventional turnbuckle.

MKIV Unit 3 Typical Boat Length 13.7 - 18.3 m (45' - 60')

Wire Ø (1 x 19 SS)	Rod Ø	Clevis pin Ø
11, 12 mm (7/16", 1/2")	-22, -30 (9.53, 11.1 mm)	19.1, 22.2 mm (3/4", 7/8")
Headstay Length	Standard 22.76 m (74'8"); max 24.89 m (81'8")	
Part No.	Description	
7413.10	Furling system*	
Toggle Assembly Required - sold separately		
7413.20 3/4	Jaw/jaw with short link plate with 19.1 mm (3/4") clevis pin	
7413.20 7/8	Jaw/jaw with short link plate with 22.2 mm (7/8") clevis pin	
7313.21 3/4	Long link plate with toggle with 19.1 mm (3/4") clevis pin	
7313.21 7/8	Long link plate with toggle with 22.2 mm (7/8") clevis pin	
Optional Parts		
7413.30	Extra 2.13 m (7') luff foil extrusion	
7413.31	Extra 248 mm (9 3/4") connector with bushings	
7426 -22	-22 rod adaptor stud (thread Ø UNF 3/4")**	
7427 -30	-30 rod adaptor stud (thread Ø UNF 7/8")**	

*Line not included. **Use with conventional turnbuckle.

MKIV Unit 4 Typical Boat Length 19.8 - 24.4 m (65' - 80')

Wire Ø (1 x 19 SS)	Rod Ø	Clevis pin Ø
12, 14, 16 mm (1/2", 9/16", 5/8")	-30, -40, -48 (11.1, 12.7, 14.3 mm)	22.2, 25.4, 28.6 mm (7/8", 1", 1 1/8")
Headstay Length	Standard 22.88 m (75'1"); max 27.15 m (89'1")	
Part No.	Description	
7414.10	Furling system*	
Toggle Assembly Required - sold separately		
7414.20 7/8	Jaw/jaw with short link plate with 22.2 mm (7/8") clevis pin	
7414.20 1	Jaw/jaw with short link plate with 25.4 mm (1") clevis pin	
7414.20 1 1/8	Jaw/jaw with short link plate with 28.57 mm (1 1/8") clevis pin	
Optional Parts		
7414.30	Extra 2.13 m (7') luff foil extrusion	
7414.31	Extra 270 mm (10 3/4") connector with bushings	
7427 -30	-30 rod adaptor stud (thread Ø UNF 7/8")**	
7428 -40	-40 rod adaptor stud (thread Ø UNF 1")**	
7429 -48	-48 rod adaptor stud (thread Ø UNF 1 1/8")**	

*Line not included. **Use with conventional turnbuckle.

7412.30
7413.30
7414.30



7412.31
7413.31
7414.31



7424 -12
7425 -17
7426 -22
7427 -30
7428 -40
7429 -48

7412.20 5/8



7312.20 5/8



7312.20 3/4

7413.20 3/4
7413.20 7/8
7414.20 7/8
7414.20 1
7414.20 1 1/8



7312.21 5/8
7312.21 3/4
7313.21 3/4
7313.21 7/8



MKIV UNDERDECK JIB REEFING & FURLING

Harken's MKIV Underdeck Jib Reefing & Furling line is the perfect solution for sailors who want an aerodynamic system with a minimal amount of equipment above deck. The underdeck furler provides a low-friction, clean layout solution that minimizes windage, while uncluttering the bow for easy anchor access. Offered in four sizes for boats from 6.7 – 18.3 m (22' – 60').



Unit 1
Unit 2
Unit 3

Unit 0

Low-friction efficiency for easy furling and reefing

- Ball bearings between center hub and deck bearing, and main shaft reduce friction; drum and halyard swivel turn freely under load.
- Foils rotate around headstay so headstay load is isolated from the unit for easy furling.

Stand up to sun, salt, and time

- Units 1, 2, 3: Aluminum line guard, torque tube, and swivels hardcoat-anodized, UV-stabilized for durability. Line guard is polyurethane-coated for additional corrosion protection. Threaded height adjuster uses dissimilar metals (stainless steel and bronze) to prevent galling.
- Unit 0: One-piece integrated aluminum deck bearing and line guard hardcoat-anodized for durability and corrosion resistance.
- Aerodynamic, clear-anodized aluminum Air foils handle extreme reefing loads.
- Triple-interlock foil joints withstand years of torque loading: foil connector's geometric shape interlocks with foil; secures with syringe-injected adhesive; screws provide final lock.

Foil joints



DO NOT use Harken equipment for human suspension unless product is specifically certified and labeled for such use.

172 STA-LOK is a registered trademark of STA-LOK Terminals.



Improved sail shape and boat control

- Independent halyard and tack swivels furl sail center before head and tack for improved sail shape when reefed.
- Lightweight aluminum halyard swivel saves weight aloft to reduce pitching and heeling.
- Tack sits at deck level, lowering the tack height for maximized sail area.
- The torque tube houses a full-length turnbuckle for optimal mast rake and tension adjustment.
- Units 1, 2, 3: High-strength universal joints articulate, allowing ample headstay sag when sailing downwind.
- Unit 0: Articulating ball joint eliminates universal joint to reduce weight, simplify maintenance.

Fast hoists, douses, reefs, and sail changes

- Precision-extruded, double-groove Air foils for smooth sail handling and fast sail changes.
- Stainless steel feeder allows fast singlehanded hoist and sail changes.

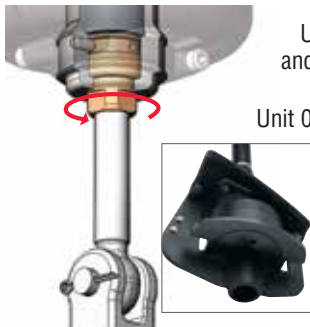

Designed for easy installation

- Units 1, 2, 3: Self-locking threaded height adjuster for correct fit between chainplate and deck.
- Unit 0: Does not require height adjuster; furler and headstay independent of each other allowing flexible installation options.
- Torque tube fits over existing turnbuckle allowing easy length adjustment. Hub assembly toggle accepts standard turnbuckle using swage, rod, Norseman, or STA-LOK® terminals.

Belowdeck drum fits narrow bows

- Small outside drum diameter.
- 
- C-shaped open connectors with low-friction plastic isolators easily slip onto headstay wire and into foil.

Easy to maintain

- Bearings require no lubrication or isolating seals.
- Through-deck bearing into underdeck compartment provides a low profile, nearly watertight system.

MKIV Underdeck Unit 0

Typical Boat Length 6.7 - 9.1 m (22' - 30')

Wire Ø (1 x 19 SS)	Rod Ø	Clevis pin Ø
5, 6 mm (3/16", 7/32")	-4, -6 (4.37, 5.03 mm)	—
Headstay Length Standard 11.7 m (38'4"); max 13.8 m (45'4")		
Part No.	Description	
7410.11	Furling system	
Optional Parts		
7410.30	Extra 2.13 m (7') luff foil extrusion	
7410.31	Extra 165 mm (6 1/2") connector with bushings	



All MKIV Underdeck furlers feature a ball bearing halyard swivel.

MKIV Underdeck Unit 1

Typical Boat Length 8.3 - 11 m (28' - 36')

Wire Ø (1 x 19 SS)	Rod Ø	Clevis pin Ø
6, 7, 8 mm (1/4", 9/32", 5/16")	-8, -10 (5.72, 6.35 mm)	12.7 mm (1/2")
Headstay Length Standard 13.99 m (45'11"); max 16.12 m (52'11")		
Part No.	Description	
7411.11 1/2	Furling system with 12.7 mm (1/2") clevis pin	
Optional Parts		
7411.30	Extra 2.13 m (7') luff foil extrusion	
7411.31	Extra 178 mm (7") connector with bushings	



7410.30
7411.30

7410.31
7411.31

Dimensions

Unit	Part No.	A		B		C	
		Min in	Max mm	Min in	Max mm	Min in	Max mm
0	7410.11	6 7/8	175	5	30.4		
1	7411.11 1/2	10 5/8	270	15 5/8	397	5 1/2	140
				4 5/8	117	9 5/8	244



7410.11

7411.11 1/2



J/122 © J/Boats

MKIV Underdeck Unit 2

Typical Boat Length 10.6 - 14.2 m (35' - 46')

Wire Ø (1 x 19 SS)	Rod Ø	Clevis pin Ø
8, 10 mm (5/16", 3/8")	-12, -17 (7.14, 8.38 mm)	15.9 mm (5/8")
Headstay Length Standard 18.38 m (60'4"); max 20.51 m (67'4")		
Part No.	Description	
7412.11 5/8	Furling system with 15.9 mm (5/8") clevis pin	
Optional Parts		
7412.30	Extra 2.13 m (7') luff foil extrusion	
7412.31	Extra 229 mm (9") connector with bushings	

MKIV Underdeck Unit 3

Typical Boat Length 13.7 - 18.3 m (45' - 60')

Wire Ø (1 x 19 SS)	Rod Ø	Clevis pin Ø
11, 12 mm (7/16", 1/2")	-22, -30 (9.53, 11.10 mm)	19.1, 22.2 mm (3/4", 7/8")
Headstay Length Standard 22.88 m (75'1"); max 25.02 m (82'1")		
Part No.	Description	
7413.11 3/4	Furling system with 19.1 mm (3/4") clevis pin	
7413.11 7/8	Furling system with 22.2 mm (7/8") clevis pin	
Optional Parts		
7413.30	Extra 2.13 m (7') luff foil extrusion	
7413.31	Extra 248 mm (9 3/4") connector with bushings	

Dimensions

Unit	Part No.	A			B			C			
		Min	Max		Min	Max		Min	Max		
		in	mm	in	mm	in	mm	in	mm	in	mm
2	7412.11 5/8	12 11/16	322	18 9/16	471	6 5/8	167	5 3/8	137	11 5/16	287
3	7413.11 3/4	16 1/8	410	23 5/8	600	8 3/16	208	6 7/8	175	14 3/8	365
3	7413.11 7/8	16 9/16	421	24 1/4	616	8 3/16	208	7 5/16	186	15	381

Francis Lee, 18.9 m (62'), Perry Sliver, Robert H. Perry design, Northwest School of Boatbuilding © Boomer Depp



7412.30
7413.30



7412.31
7413.31

7412.11 5/8
7413.11 3/4
7413.11 7/8





Elan Impression 494, 14.85 m, Rob Humphreys Yacht Design/Elan © Aljosa Robolj

ESP JIB REEFING & FURLING

Fewer components make this affordable furling system a favorite of cruising sailors. These furlers are quick to assemble and easy to use, while providing the same styling, durability, and low-maintenance bearing system of Harken's MKIV line. Install an ESP furler and trim safely from the cockpit when it blows; unfurl instead of motoring when it's light for a great day of sailing. Four sizes fit boats from 6 - 18.6m (20' - 61').



Low-friction efficiency for smooth furling and reefing

- Three rows of large-diameter Delrin® ball bearings minimize friction.
- Round foil withstands extreme reefing loads; furls more easily than flat foil shapes.

Stands up to sun, salt, and time

- Hard Lube-anodized aluminum hub; fiber-reinforced composite one-piece drum, spool, and guard.
- Stainless steel guard posts for impact and corrosion resistance.
- Stainless steel feeder and clear-anodized aluminum foils for durability.
- Tough foil joints withstand years of torque loading; foil connectors and geometric shape interlocks with foil and secures with screws.

Foil joints





Adjust drum height to fit boat or sailing style

- Leg kits adjust drum height to clear anchor, increase visibility, or bring sail closer to deck.
- Long or medium leg kits: Use with furlers with turnbuckles using swage, Norseman, or STA-LOK® terminals; to select correct size, refer to unit pages. Medium leg kit fits a variety of turnbuckles: refer to height chart on unit pages.
- Short leg kit: does not fit turnbuckle; attach to marine eye at bottom of stay for increased sail area.



Designed for easy assembly

- Foils slip over standard marine eye and headstay wire for easy installation — no need to cut wire.
- Cut only top foil to fit; adjustable bottom foil fine-tunes system length.
- Attach sail to tack and head shackle; sail shape controlled by halyard tension.



Easy to maintain

- Bearings require no lubrication or isolating seals.



Lead block kit



Halyard deflector



Furling line

Accessories

- Lead block kit: Easy-to-mount ball bearing blocks lead line aft; fit 25 mm (1") stanchions.
- Halyard deflector: Install above the foil to prevent halyards from wrapping around the foil when furling.
- Line: Specially formulated low-stretch black line is abrasion and UV-resistant for units 0, 1, 2.



HFG594
HFG233

7420 -4
7421 -8
7422 -8
7423 -10



7320.31
7321.31



7320.30
7321.30

OPTIONAL PARTS

ESP Unit 0

Typical Boat Length 6 - 8.5 m (20' - 28')

Wire Ø (1 x19 SS)	Rod Ø	Clevis pin Ø
4, 5 mm (5/32", 3/16")	-4 (4.37 mm)	7.9, 9.5 mm (5/16", 3/8")

Headstay Length* Standard 10.92 m (35'10"); max 12.92 m (42'5")

Part No.	Description
7320.10	Furling system

Leg Kit Required - sold separately See toggle and rigging options page 167.

7320.20 5/16	Short leg kit with toggle with 7.9 mm (5/16") clevis pin. Not for turnbuckle**
7320.20 3/8	Short leg kit with toggle with 9.5 mm (3/8") clevis pin. Not for turnbuckle**
7320.21 5/16	Long leg kit with toggle with 7.9 mm (5/16") clevis pin‡
7320.21 3/8	Long leg kit with toggle with 9.5 mm (3/8") clevis pin‡

Optional Parts	
7320.30	Extra 2 m (6.5') luff foil extrusion
7320.31	Extra 216 mm (8.5") standard connector with bushings
7420 -4	-4 rod adaptor stud (thread Ø UNF 7/16")
HFG594	7 mm x 16.8 m (55') polyester double braid line. Not included in furling system. ††

*When using long leg kits add .13 m (5"). **Use without turnbuckle. ‡Use with conventional turnbuckle. ††To use own line, figure 2 X boat length.

ESP Unit 1

Typical Boat Length 7.9 - 10.6 m (26' - 35')

Wire Ø (1 x 19 SS)	Rod Ø	Clevis pin Ø
6, 7, 8 mm (7/32", 1/4", 9/32", 5/16")	-6, -8, -10 (5.03, 5.72, 6.35 mm)	11.1, 12.7 mm (7/16", 1/2")

Headstay Length* Standard 13 m (42'7"); max 17 m (55'8")

Part No.	Description
7321.10	Furling system

Leg Kit Required - sold separately See toggle and rigging options page 167.

7321.20 7/16	Short leg kit with toggle with 11.1 mm (7/16") clevis pin. Not for turnbuckle**
7321.20 1/2	Short leg kit with toggle with 12.7 mm (1/2") clevis pin. Not for turnbuckle**
7321.22 7/16	Medium leg kit with toggle with 11.1 mm (7/16") clevis pin‡
7321.22 1/2	Medium leg kit with toggle with 12.7 mm (1/2") clevis pin‡
7321.21 7/16	Long leg kit with toggle with 11.1 mm (7/16") clevis pin‡
7321.21 1/2	Long leg kit with toggle with 12.7 mm (1/2") clevis pin‡

Optional Parts	
7321.30	Extra 2 m (6.5') luff foil extrusion Order 1 for stay lengths to 15.22 m (49'11")* Order 2 for stay lengths to 17.22 m (56'6")*
7321.31	Extra 229 mm (9") standard connector with bushings Order 1 for stay lengths to 15.22 m (49'11")* Order 2 for stay lengths to 17.22 m (56'6")*
7421 -6	-6 rod adaptor stud (thread Ø UNF 7/16")
7422 -8	-8 rod adaptor stud (thread Ø UNF 1/2")
7423 -10	-10 rod adaptor stud (thread Ø UNF 1/2")
HFG233	7 mm x 21.3 m (70') polyester double braid line. Not included in furling system. ††

*Add for longer leg kits. Medium leg .095 m (3 3/4") Long leg .22 m (8 1/2"). **Use without turnbuckle. ‡Use with conventional turnbuckle. Check maximum turnbuckle length for medium leg kit. ††To use own line, figure 2 X boat length.

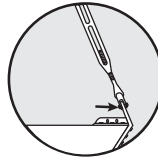
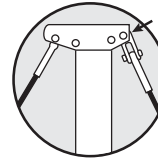

Pin-to-pin measurement points



7321.22 7/16
7321.22 1/2

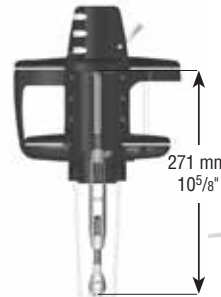

Medium leg kit max turnbuckle length



Medium leg kit



7320.20 5/16
7320.20 3/8
7321.20 7/16
7321.20 1/2



7320.21 5/16
7320.21 3/8
7321.21 7/16
7321.21 1/2

Long leg kit



Short leg kit



Optional
HFG235

7424 -12
7425 -17
7426 -22
7427 -30
7428 -40



7322.31
7323.31

7322.30
7323.30

OPTIONAL PARTS

ESP Unit 2

Typical Boat Length 10.4 - 14 m (34' - 46')

Wire Ø (1 x 19 SS)	Rod Ø	Clevis pin Ø
8, 10, 12 mm (5/16", 3/8", 7/16")	-12 -17, -22 (7.14, 8.38, 9.53 mm)	15.9, 19.1 mm (5/8", 3/4")

Headstay Length* Standard 17.05 m (55'11"); max 21.05 m (69')

Part No.	Description
7322.10	Furling system

Leg Kit Required - order separately See toggle and rigging options page 167.

7322.20 5/8	Short leg kit with toggle with 15.9 mm (5/8") clevis pin. Not for turnbuckle**
7322.20 3/4	Short leg kit with toggle with 19.1 mm (3/4") clevis pin. Not for turnbuckle**
7322.22 5/8	Medium leg kit with toggle with 15.9 mm (5/8") clevis pin‡
7322.22 3/4	Medium leg kit with toggle with 19.1 mm (3/4") clevis pin‡
7322.21 5/8	Long leg kit with toggle with 15.9 mm (5/8") clevis pin‡
7322.21 3/4	Long leg kit with toggle with 19.1 mm (3/4") clevis pin‡

Optional Parts

7322.30	Extra 2 m (6.5') luff foil extrusion Order 1 for stay lengths to 19.33 m (63'5")* Order 2 for stay lengths to 21.33 m (70')*
7322.31	Extra 240 mm (9.5") standard connector with bushings Order 1 for stay lengths to 19.33 m (63'5")* Order 2 for stay lengths to 21.33 m (70')*
7424 -12	-12 rod adaptor stud (thread Ø UNF 5/8")
7425 -17	-17 rod adaptor stud (thread Ø UNF 5/8")
7426 -22	-22 rod adaptor stud (thread Ø UNF 3/4")
HFG235	8 mm x 30.5 m (100') polyester double braid line. Not included in furling system. ††

*Add to length for longer leg kits. Medium leg .175 m (7") Long leg .305 m (12"). **Use without turnbuckle.
‡Use with conventional turnbuckle. Check maximum turnbuckle length for medium leg kit.
††To use own line figure 2 X boat length.

ESP Unit 3

Typical Boat Length 13.7 - 18.6 m (45' - 61')

Wire Ø (1 x 19 SS)	Rod Ø	Clevis pin Ø
12.7, 14, 16 mm (1/2", 9/16", 5/8")	-22, -30, -40 (9.53, 11.10, 12.7 mm)	22.2, 25.4 mm (7/8", 1")

Headstay Length* Standard 21.15 m (69'5"); max 25.15 m (82'7")

Part No.	Description
7323.10	Furling system

Leg Kit Required - order separately See toggle and rigging options page 167.

7323.20 7/8	Short leg kit with toggle with 22.2 mm (7/8") clevis pin. Not for turnbuckle**
7323.20 1	Short leg kit with toggle with 25.4 mm (1") clevis pin. Not for turnbuckle**
7323.22 7/8	Medium leg kit with toggle with 22.2 mm (7/8") clevis pin‡
7323.22 1	Medium leg kit with toggle with 25.4 mm (1") clevis pin‡
7323.21 7/8	Long leg kit with toggle with 22.2 mm (7/8") clevis pin‡
7323.21 1	Long leg kit with toggle with 25.4 mm (1") clevis pin‡

Optional Parts

7323.30	Extra 2 m (6.5') luff foil extrusion Order 1 for stay lengths to 23.5 m (77'1")* Order 2 for stay lengths to 25.5 m (83'8")*
7323.31	Extra 267 mm (10.5") standard connector with bushings Order 1 for stay lengths to 23.5 m (77'1")* Order 2 for stay lengths to 25.5 m (83'8")*
7426 -22	-22 rod adaptor stud (thread Ø UNF 3/4")
7427 -30	-30 rod adaptor stud (thread Ø UNF 7/8")
7428 -40	-40 rod adaptor stud (thread Ø UNF 1")

Use 12 mm (7/16") double braid furling line not supplied by Harken. To figure line length use 2 X boat length.

*Add to length for longer leg kits. Medium leg .215 m (8 1/2") Long leg .37 m (14 1/2"). **Use without turnbuckle.
‡Use with conventional turnbuckle. Check maximum turnbuckle length for medium leg kit.

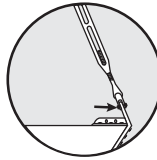
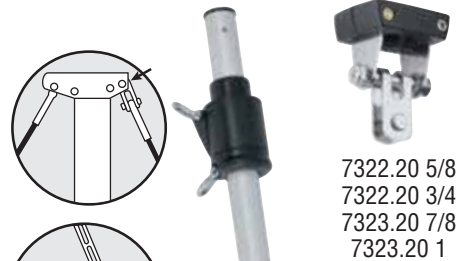

Pin-to-pin
measurement points



7322.22 5/8
7322.22 3/4
7323.22 7/8
7323.22 1



7322.20 5/8
7322.20 3/4
7323.20 7/8
7323.20 1

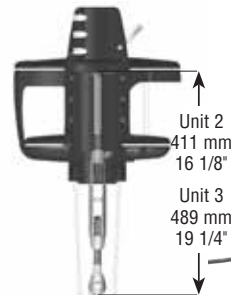

Unit 2
411 mm
16 1/8"

Unit 3
489 mm
19 1/4"

Medium leg kit
max turnbuckle
length

Long
leg kit



Medium
leg kit



Short
leg kit





ELECTRIC JIB REEFING & FURLING

A Harken Electric Jib Reefing and Furling system is a simple solution for sailors looking to add push-button comfort and safety to their cruiser. These sleek free-rolling systems are easy to install and allow crew to quickly furl and reef from the cockpit, while maintaining sail shape and optimal speed. For boats from 10.6 - 18 m (35' - 60').



Easy to furl

- Stacked Torlon® bearing races in the halyard swivel evenly distribute radial and thrust loads to ball bearings.

Stands up to sun, salt, and time

- Torque tube, motor, and gear housing are deep-saturation hardcoat-anodized, UV-stabilized aluminum for durability.
- The sculpted gearbox and streamlined motor housing are sealed with high-quality lip seals and O-rings.
- Stainless steel link plates resist scratches from anchor and are easily repolished.
- Hardened steel gears are permanently lubricated.
- Triple-interlock foil joints withstand years of torque loading: foil connectors geometric shape interlocks with foil; secures with syringe-injected adhesive, screws provide final lock.

Foil joints





Improved sail shape and boat control

- Independent halyard and tack swivels furl sail center before head and tack for improved sail shape when reefed.
- Lightweight aluminum halyard swivel saves weight aloft to reduce pitching and heeling.



High-torque, high-efficiency motor consumes little power

- Permanent magnet design motor gives off little heat; reduces condensation to prevent electrical shorts.
- Reversible drive uses a high reduction worm gear to prevent sails from unfurling under load.



Emergency manual operation in case of power loss

- Use supplied crank handle or cordless drill adapter, or use standard winch handle.



Simple to install or upgrade from manual to electric

- Vertical motor's streamlined housing fits narrow pulpits, clears anchor tackle, and provides low windage.
- C-shaped connectors slip over headstay without feeding wire through connector.
- Lower unit fits over existing turnbuckle allowing easy length adjustment. Harken toggle assembly accepts standard turnbuckle using swage, rod, Norseman, or STA-LOK® terminals.
- Unit easily connects to boat's existing electrical system.
- Easy upgrades from the MKIV Unit 2 and Unit 3 manual units with the Harken Upgrade Kit.

Options

- Upgrade kits available for manual-to-electric conversion.
- Systems available in 12- or 24-volts; dual-function switch and a 12- or 24-volt control box and circuit breaker included.

Unit 2E Typical Boat Length 10.6 - 14.2 m (35' - 46')

Wire Ø (1 x 19 SS)	Rod Ø	Clevis pin Ø
8, 10 mm (5/16", 3/8")	-12 -17, -22 (7.14, 8.38, 9.53 mm)	15.9, 19.1 mm (5/8", 3/4")

Headstay Length Standard 18.57 m (60'11"); max 20.7 m (67'11")

Part No.	Description
7412.13 12V	Furling system 12-volt with control box, switches, and circuit breaker
7412.13 24V	Furling system 24-volt with control box, switches, and circuit breaker

Toggle Assembly Required - sold separately

7312.22 5/8	Jaw/jaw with link plate with 15.9 mm (5/8") clevis pin
7413.22 3/4	Jaw/jaw with link plate with 19.1 mm (3/4") clevis pin

Optional Parts

7406	Through-deck fitting for power cable
7412.12V.CONV	Conversion kit MKIV manual to 12V-electric*
7412.24V.CONV	Conversion kit MKIV manual to 24V-electric*
7412.30	Extra 2.13 m (7') luff foil extrusion
7412.31	Extra 229 mm (9") connector with bushings
7424 -12	-12 rod adaptor stud (thread Ø UNF 5/8")**
7425 -17	-17 rod adaptor stud (thread Ø UNF 5/8")**
7426 -22	-22 rod adaptor stud (thread Ø UNF 3/4")**

*Includes switch and 12- or 24-volt control box and circuit breaker. Requires toggle assembly.
** Use with conventional turnbuckle.



7412.13 12V
7412.13 24V

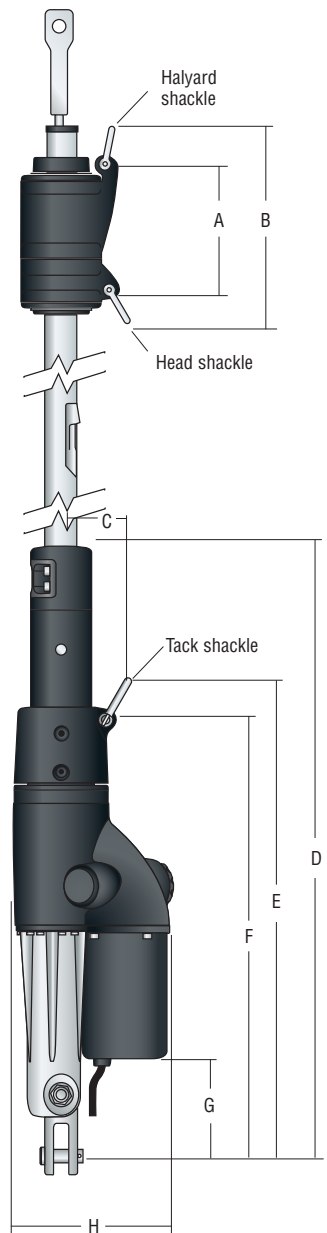

Unit 3E Typical Boat Length 13.7 - 18.3 m (45' - 60')

Wire Ø (1 x 19 SS)	Rod Ø	Clevis pin Ø
11, 12 mm (7/16", 1/2")	-22, -30 (9.53, 11.1 mm)	19.1, 22.2 mm (3/4", 7/8")

Headstay Length Standard 22.88 m (75'1"); max 25.02 m (82'1")

Part No.	Description
7413.13 12V	Furling system 12-volt with control box, switches, and circuit breaker
7413.13 24V	Furling system 24-volt with control box, switches, and circuit breaker

Toggle Assembly Required - sold separately

7413.22 3/4	Jaw/jaw with link plate with 19.1 mm (3/4") clevis pin
7413.22 7/8	Jaw/jaw with link plate with 22.2 mm (7/8") clevis pin

Optional Parts

7406	Through-deck fitting for power cable
7413.12V.CONV	Conversion kit MKIV manual to 12V-electric*
7413.24V.CONV	Conversion kit MKIV manual to 24V-electric*
7413.30	Extra 2.13 m (7') luff foil extrusion
7413.31	Extra 248 mm (9 3/4") connector with bushings
7426 -22	-22 rod adaptor stud (thread Ø UNF 3/4")**
7427 -30	-30 rod adaptor stud (thread Ø UNF 7/8")**

* Includes switch and 12- or 24-volt control box and circuit breaker. Requires toggle assembly. **Use with conventional turnbuckle.



7413.13 12V
7413.13 24V

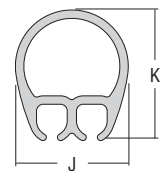

Unit 2E, 3E



7406



7412.31
7413.31



7412.30
7413.30



7424 -12
7425 -17
7426 -22
7427 -30



7312.22 5/8
7413.22 3/4
7413.22 7/8

Foil Dimensions

Unit	Part No.	J		K		Foil length		Luff tape*	
		in	mm	in	mm	ft/in	m	in	mm
2E	7412.30	1 1/4	32	1 3/8	36	7'	2.13	#6 (6/32)	5
3E	7413.30	1 1/2	38	1 11/16	43	7'	2.13	#6 (6/32)	5

*Nominal dimensions only, actual luff tape dimensions are larger.

Electric Furler Dimensions

Part No.	A		B		C		D		E		F		G		H	
	in	mm	in	mm	in	mm	in	mm	in	mm	in	mm	in	mm	in	mm
7412.13 with 7312.22 5/8 toggle	5 3/8	143	9 1/8	231	3 1/4	82	33 1/16	841	24 1/2	622	22 5/8	574	4 1/2	116	8 11/32	212
7412.13 with 7413.22 3/4 toggle	5 3/8	143	9 1/8	231	3 1/4	82	33 11/16	856	25 3/32	637	23 1/4	590	5 3/16	132	8 11/32	212
7413.13 with 7413.22 3/4 toggle	7 5/16	186	11 5/8	296	3 1/4	82	32 1/2	826	25 3/32	637	23 1/4	590	5 3/16	132	8 11/32	212
7413.13 with 7413.22 7/8 toggle	7 5/16	186	11 5/8	296	3 1/4	82	33 3/16	840	25 11/16	652	23 13/16	605	5 3/4	146	8 11/32	212

Jib Reefing and Furling Dimensions

MKIV Using Toggle*

Unit	Part No.	A		B		C		D		E	
		in	mm	in	mm	in	mm	in	mm	in	mm
0	7410.10	3 3/4	96	5 7/8	150	1 7/8	47	5 1/2	140	2 5/8	66
1	7411.10	4 3/4	120	7	178	2	51	6 5/8	167	3 1/16	78
2	7412.10	5 5/8	143	9 1/8	231	2 9/16	66	8 3/16	208	3 13/16	97
3	7413.10	7 5/16	186	11 5/8	296	3 3/8	86	9 3/4	247	4 3/4	121
4	7414.10	8 15/16	227	**	**	**	**	11 1/16	280	5 1/8	130

Unit	Part No.	F		G		H		I									
		Max ‡	Min	Max ‡	Min	Max ‡	Min	Max ‡	Min								
		in	mm	in	mm	in	mm	in	mm								
0	7410.10	41	1041	39 1/4	997	8 3/8	213	8	203	7 5/16	186	7	175	2 5/16	59	2	51
1	7411.10	46 1/4	1175	42 1/4	1073	12	305	9 3/4	247	11	280	8 3/4	222	5	129	2 7/8	71
2	7412.10	51 3/4	1314	46 3/4	1187	15 1/8	384	12 1/16	306	13 15/16	348	10 7/8	276	6 7/16	164	3 3/8	85
3	7413.10	50 5/8	1286			18 7/16	467			16 5/8	420			7 3/8	188		
4	7414.10	55 5/16	1405			**	**	**	**	20	509			8 5/8	220		

*See MKIV long link plate dimensions below. ** Soft-attachment tack, head, and halyard; distance varies.
 ‡Max refers to using stud jaw toggle. Use Min when adding long link plate dimensions.

ESP Using Short Leg Kit*

Unit	Part No.	A		B		C		D		E		F		G		H		I			
		in	mm	in	mm	in	mm	in	mm	in	mm	Max ‡	Min ‡	in	mm	in	mm	in	mm		
0	7320.10	1 7/8	48	4 9/16	116	1 3/8	35	6 1/2	166	2 5/8	66	37 7/8	962	22 1/2	572	8 5/16	211	7 7/16	190	3	76
1	7321.10	2 3/4	70	5 1/8	131	1 3/8	35	8	200	3	78	38 9/16	980	23 7/16	595	9 7/8	251	9 1/16	230	3 11/16	93
2	7322.10	3 7/8	99	7 5/16	185	2	51	9 7/8	250	3 5/8	97	40 3/4	1034	25	635	12 15/16	329	11 13/16	300	4 15/16	125
3	7323.10	5 1/8	130	9 7/16	240	2 1/8	53	11 3/4	298	4 3/4	121	42 15/16	1091	27	686	16 1/16	408	14 5/8	370	6 1/2	165

*See ESP medium and long leg kit dimensions below.
 ‡‡ F Max and Min are dependent on foil position at adjuster tube.

ESP Medium and Long Leg Kit

*Note: If medium or long leg kit is used, add the following dimensions to F, G, H, and I.				
ESP leg kit	Medium leg kit-add	Long leg kit-add		
Unit 0	—	—	5"	130 mm
Unit 1	3 3/4"	95 mm	8 3/4"	220 mm
Unit 2	7"	176 mm	11 3/4"	300 mm
Unit 3	8 1/2"	215 mm	14 1/2"	370 mm

MKIV Long Link Plate

*Note: If a long link plate is used, add the following dimensions to F, G, H, and I (based on whether plate is used full-length or shortened to one of five hole positions).		
Unit 1	12.7 mm (1/2") clevis pin	Add 337–168 mm (13 1/4"–6 5/8")
	15.9 mm (5/8") clevis pin	Add 286–111 mm (11 1/4"–4 3/8")
Unit 2	15.9 mm (5/8") clevis pin	Add 410–210 mm (16 1/8"–8 1/4")
	19.1 mm (3/4") clevis pin	Add 344–144 mm (13 9/16"–5 11/16")
Unit 3	19.1 mm (3/4") clevis pin	Add 497–271 mm (19 9/16"–10 11/16")
	22.2 mm (7/8") clevis pin	Add 505–279 mm (19 7/8"–11")

Foil Dimensions

System	Unit	Part No.	J		K		Foil length		Luff tape*	
			in	mm	in	mm	ft/in	m	in	mm
MKIV	0	7410.30	7/8	23	1 1/32	26	7'	2.13	#6 (6/32)	5
	1	7411.30	1	25	1 1/8	29	7'	2.13	#6 (6/32)	5
	2	7412.30	1 1/4	32	1 3/8	36	7'	2.13	#6 (6/32)	5
	3	7413.30	1 1/2	38	1 11/16	43	7'	2.13	#6 (6/32)	5
ESP	0	7320.30	1 1/4	31			6' 6 3/4"	2	#6 (6/32)	5
	1	7321.30	1 9/16	40			6' 6 3/4"	2	#6 (6/32)	5
	2	7322.30	2 1/8	53.5			6' 6 3/4"	2	#6 (6/32)	5
	3	7323.30	2 3/4	69			6' 6 3/4"	2	#6 (6/32)	5

*Nominal dimensions only, actual luff tape dimensions are larger.

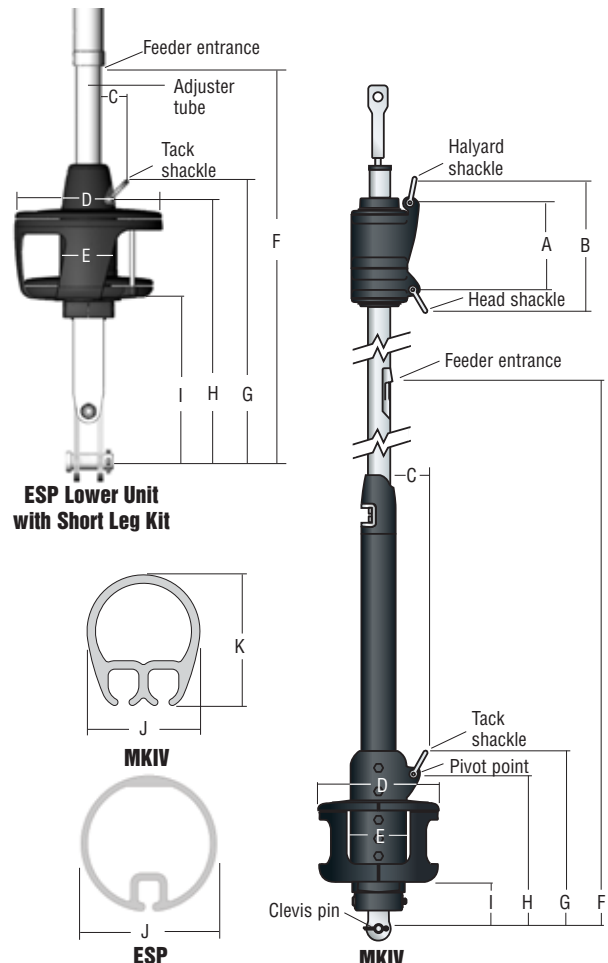

MKIV HYDRAULIC JIB REEFING & FURLING

Powerful performance packed into a compact, slim profile makes our hydraulic headsail furlers the ultimate in push-button sail control. Perfect for cruisers and performance cruisers, these free-rolling systems fit wire sizes from 11 - 25 mm (7/16" - 1"); rod from -22 to -115 or equivalent fiber stays. Parts and service are available around the world.

Low-friction efficiency for easy furling and reefing

- Multiple rows of Torlon® ball bearings in high-load areas minimize friction.
- Stacked bearing races evenly distribute radial and thrust loads; halyard swivel turns freely under load.

Standard transmission reduces mechanical friction and pressure loss

- Engages/disengages the motor's powered and manual gear drive for efficient operation.
- Worm gear drive prevents backwinding; unloads hydraulic motor when reefed.

High-strength, lightweight

- Hardcoat-anodized, UV-stabilized aluminum torque tube, motor, and gear housing.
- Aerodynamic, clear-anodized aluminum Air foils handle extreme reefing loads; carbon fiber foils available on request.
- Triple-interlock foil joints withstand years of torque loading; foil connectors geometric shape interlocks with foil; secures with syringe-injected adhesive; screws provide final lock.



Foil joints

Carbon foil

DO NOT use Harken equipment for human suspension unless product is specifically certified and labeled for such use.



Improved sail shape and boat control

- Independent halyard and tack swivels furl sail center before head and tack for improved sail shape when reefed.
- Lightweight aluminum halyard swivel saves weight aloft to reduce pitching and heeling.
- Unit 3 uses a hard shackle. Units 4 through 6 lashed on with Spectra® line; patented system evenly distributes loads.
- Lower unit's compact size brings sail's tack close to deck.



Fast hoists, douses, reefs, and sail changes

- Precision-extruded, double-groove Air foils for smooth sail handling and fast sail changes.
- Stainless steel feeder allows fast single-handed hoist and sail changes.



Emergency manual operation in case of power loss

- Use supplied crank handle or cordless drill adapter, or use standard winch handle.

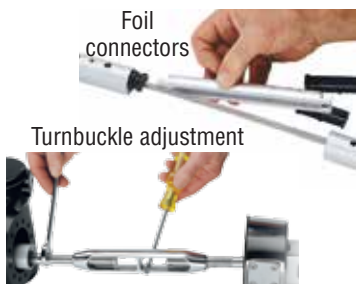

Designed for easy installation

- C-shaped open connectors with low-friction plastic isolators easily slip onto headstay wire and into foil.
- Lower unit fits over existing turnbuckle allowing easy length adjustment. Harken toggle assembly accepts standard turnbuckle using swage, rod, Norseman, or STA-LOK® terminals.
- Lower toggle assembly fixes at 90-degree intervals, accepts any chainplate direction.
- Motor has no case drain line for easier installation; fewer hoses.



Easy to maintain

- Bearings require no lubrication or isolating seals.
- Hardened steel gears and bearings in lower unit permanently lubricated in oil bath.
- Fewer parts easier to assemble and service.



Options

- A hydraulic cylinder installed below unit adjusts headstay, keeps luff tension constant. This prevents halyard and tack attachments from overloading when the headstay is adjusted.

Torlon is a registered trademark of Solvay Advanced Polymers L.L.C.
Spectra is a registered trademark of Honeywell International, Inc.
STA-LOK is a registered trademark of STA-LOK Terminals.

MKIV Hydraulic Jib Reefing & Furling



7413.30
7414.30

Contact Harken for
availability of carbon foils

7413.31
7414.31S
7414.31L

7426 -22
7427 -30
7428 -40
7429 -48

7413.25 3/4
7413.25 7/8
7414.25 7/8
7414.25 1
7414.25 1 1/8



Manual operation switch
and gear socket



Unit 3



Unit 4



Unit 3
Unit 4

Unit 3

Wire Ø (1 x 19 SS)	Rod Ø	Clevis pin Ø
11, 12 mm (7/16", 1/2")	-22, -30 (9.53, 11.1 mm)	19, 22.2 mm (3/4", 7/8")
Headstay Length	Aluminum foil: standard 22.77 m (74'9"), max 24.91 m (81'9")	
Part No.	Description	
7413.15	Furling system with aluminum foils	
Toggle Assembly Required - sold separately		
7413.25 3/4	Toggle for 19 mm (3/4") clevis pin	
7413.25 7/8	Toggle for 22.2 mm (7/8") clevis pin	
Optional Parts		
7413.30	Extra 2.13 m (7') luff foil extrusion	
7413.31	Extra 248 mm (9 3/4") connector with bushings	
7426 -22	-22 rod adaptor stud (thread Ø UNF 3/4")	
7427 -30	-30 rod adaptor stud (thread Ø UNF 7/8")*	

Contact Harken to request quote and lead time. *Use with conventional turnbuckle.

Unit 4

Wire Ø (1 x 19 SS)	Rod Ø	Clevis pin Ø
12, 14, 16 mm (1/2", 9/16", 5/8")	-30, -40, -48 (11.1, 12.7, 14.3 mm)	22.2, 25.4, 28.6 mm (7/8", 1", 1 1/8")
Headstay Length	Aluminum foil: standard 22.93 m (75'3"), max 29.33 m (96'3")	
Part No.	Description	
7414.15S	Furling system with aluminum foils and small bushings; fits -30, -40 rod, 12 mm (1/2") wire	
7414.15L	Furling system with aluminum foils and large bushings; fits -48 rod, 14, 16 mm (9/16", 5/8") wire	
Toggle Assembly Required - sold separately		
7414.25 7/8	Toggle for 22.2 mm (7/8") clevis pin	
7414.25 1	Toggle for 25.4 mm (1") clevis pin	
7414.25 1 1/8	Toggle for 28.6 mm (1 1/8") clevis pin	
Optional Parts		
7414.30	Extra 2.13 m (7') luff foil extrusion	
7414.31S	Extra 270 mm (10 3/4") connector with small bushings, fits -30, -40 rod, 12 mm (1/2") wire	
7414.31L	Extra 270 mm (10 3/4") connector with large bushings, fits -48 rod, 14, 16 mm (9/16", 5/8") wire	
7427 -30	-30 rod adaptor stud (thread Ø UNF 7/8")	
7428 -40	-40 rod adaptor stud (thread Ø UNF 1")	
7429 -48	-48 rod adaptor stud (thread Ø UNF 1 1/8")*	

Contact Harken to request quote and lead time. *Use with conventional turnbuckle.

MKIV Hydraulic Jib Reefing & Furling



7415.30
7416.30

7415.31S
7415.31M
7415.31L
7416.31S
7416.31M
7416.31L

Contact Harken for availability of carbon foils.

7429 -48



7415.25 1 1/8
7415.25 1 1/4
7415.25 X X/X
7416.25 1 1/4
7416.25 1 3/8
7416.25 1 9/16
7416.25 X X/X



Unit 5

Wire Ø (1 x 19 SS)	Rod Ø	Clevis pin Ø
16, 19, 22 mm (5/8", 3/4", 7/8")	-48, -60, -76‡ (14.3, 16.8, 17.9 mm)	28.6, 31.8 mm (1 1/8", 1 1/4")
Headstay Length	7415.15S aluminum foil: standard 23.8 m (78'), max 34.7 m (114'); 7415.15M and 7415.15L aluminum foil: standard 26.5 m (87'), max 34.7 m (114')	
Part No.	Description	
7415.15S	Furling system with aluminum foils and small bushings; fits -48, -60 rod, 16 mm (5/8") wire	
7415.15M	Furling system with aluminum foils and medium bushings; fits -76 rod	
7415.15L	Furling system with aluminum foils and large bushings; fits 19, 22 mm (3/4", 7/8") wire	
Toggle Assembly Required - sold separately		
7415.25 1 1/8	Toggle for 28.6 mm (1 1/8") clevis pin	
7415.25 1 1/4	Toggle for 31.8 mm (1 1/4") clevis pin	
7415.25 X X/X*	Toggle for all other clevis pin sizes (customer supplied dimensions)	
Optional Parts		
7415.30	Extra 2.74 m (9') aluminum foil extrusion	
7415.31S	Extra 305 mm (12") connector with small bushings; fits -48, -60 rod, 16 mm (5/8") wire	
7415.31M	Extra 305 mm (12") connector with medium bushings; fits -76 rod	
7415.31L	Extra 305 mm (12") connector with large bushings; fits 19, 22 mm (3/4", 7/8") wire	
7429 -48	-48 rod adaptor stud (thread Ø UNF 1 1/8")**	

Contact Harken to request quote and lead time. ‡Continuous rod only. If rod is sectional, order Unit 6.

*Specify rigging dimensions when ordering. **Use with conventional turnbuckle.

Unit 6

Wire Ø (1 x 19 SS)	Rod Ø	Clevis pin Ø
22, 25 mm (7/8", 1")	-76, -91, -115 (17.9, 19.5, 22.2 mm)	31.8, 34.9, 39.7 mm (1 1/4", 1 3/8", 1 9/16")
Headstay Length	Aluminum foil: standard 28.8 m (94'6"), max 38.8 m (127'6")	
Part No.	Description	
7416.15S	Furling system with aluminum foils and small bushings; fits -76 rod	
7416.15M	Furling system with aluminum foils and medium bushings; fits -91 rod	
7416.15L	Furling system with aluminum foils and large bushings; fits -115 rod, 22, 25 mm (7/8", 1") wire	
Toggle Assembly Required - sold separately		
7416.25 1 1/4	Toggle for 31.8 mm (1 1/4") clevis pin	
7416.25 1 3/8	Toggle for 34.9 mm (1 3/8") clevis pin	
7416.25 1 9/16	Toggle for 39.7 mm (1 9/16") clevis pin	
7416.25 X X/X*	Toggle for all other clevis pin sizes (customer supplied dimensions)	
Optional Parts		
7416.30	Extra 3.35 m (11') aluminum foil extrusion	
7416.31S	Extra 330 mm (13") connector with small bushings; fits -76 rod	
7416.31M	Extra 330 mm (13") connector with medium bushings; fits -91 rod	
7416.31L	Extra 330 mm (13") connector with large bushings; fits -115 rod, 22, 25 mm (7/8", 1") wire	

Contact Harken to request quote and lead time. *Specify rigging dimensions when ordering.



Unit 4
Unit 5
Unit 6

Hydraulic Furling Dimensions

Unit	Part No.	A		B		C		D*		E**		Min	
		in	mm	in	mm	in	mm	in	mm	in	mm	in	mm
3	7413.15	7 5/16	186	12	300	8 1/4	209	3 1/4	80	47 9/16	1209	47	1194
4	7414.15S/L	8 15/16	227	14 1/4	360	8 7/8	225	4 1/2	115	55 1/2	1409	54 3/8	1381
5	7415.15S/M/L	10 1/2	267	17	430	10 3/8	264	5	120	63 1/2	1613	62 13/16	1596
6	7416.15S/M/L	12 1/2	314	20 1/2	520	11 3/16	285	6 5/16	160	67 3/8	1711	66 1/16	1679

*From boltrope

**If hydraulic cylinder is used, dimensions E through I will increase according to cylinder length and settings. See cylinder length addition chart. See installation manual for detailed cylinder dimension information.

Unit	Part No.	F**		G**		H**		I**		J		K	
		Max in	Max mm	Min in	Min mm	Max in	Max mm	Min in	Min mm	Max in	Max mm	Min in	Min mm
3	7413.15	32 7/8	836	32 5/16	821	18 7/8	480	18 1/2	470	16 11/16	424	16 1/8	409
4	7414.15S/L	38 1/4	971	37 1/8	943	22 1/4	565	21 1/4	540	19 11/16	500	18 9/16	472
5	7415.15S/M/L	41 11/16	1059	41	1042	27 1/2	700	26 3/4	680	24 1/2	619	23 11/16	602
6	7416.15S/M/L	46 9/16	1183	45 1/4	1150	30 3/8	770	28 3/4	730	26 1/4	666	25	634

**If hydraulic cylinder is used, dimensions E through I will increase according to cylinder length and settings. See cylinder length addition chart. See installation manual for detailed cylinder dimension information.

Unit	Part No.	I**		J		K		L**		M		N	
		Max in	Max mm	Min in	Min mm	Max in	Max mm	Min in	Min mm	Max in	Max mm	Min in	Min mm
3	7413.15	5 3/16	132	4 5/8	118	2 9/16	65	2	51	11 9/16	293	6 7/8	174
4	7414.15S/L	6 5/16	160	5 3/16	132	3 3/4	95	2 5/8	66	13 7/8	353	7 3/8	188
5	7415.15S/M/L	7 1/4	185	6 5/8	168	4 5/16	109	3 5/8	92	15 13/16	402	9 1/8	232
6	7416.15S/M/L	8 9/16	218	7 1/4	185	5 7/16	139	4 3/16	106	18 7/16	469	9 13/16	249

**If hydraulic cylinder is used, dimensions E through I will increase according to cylinder length and settings. See cylinder length addition chart. See installation manual for detailed cylinder dimension information.

Cylinder Length Addition

Unit	Part No.	Add min length		Add max length		Stroke length	
		in	mm	in	mm	in	mm
3	7413.15	14 7/8	378	19	483	4	100
4	7414.15S/L	16 1/4	413	21 5/8	549	5	125
5	7415.15S/M/L	18 7/8	479	24 7/8	631	6	150
6	7416.15S/M/L	21 1/16	535	28 7/16	722	7	175

Foil Dimensions

Unit	Part No.	L		M		Foil length		Luff tape*	
		in	mm	in	mm	ft	m	in	mm
3	7413.30	1 1/2	38	1 11/16	43	7'	2.13	#6 (6/32)	5
4	7414.30	1 3/4	44	1 27/32	47	7'	2.13	#6 (6/32)	5
5	7415.30	2 13/32	61	2 5/8	63	9'	2.74	#6 (6/32), #7 (7/32)	5, 6
6	7416.30	3 3/16	82	3 9/32	83	11'	3.35	#6 (6/32), #7 (7/32)	5, 6

*Nominal dimensions only, actual luff tape dimensions are larger.

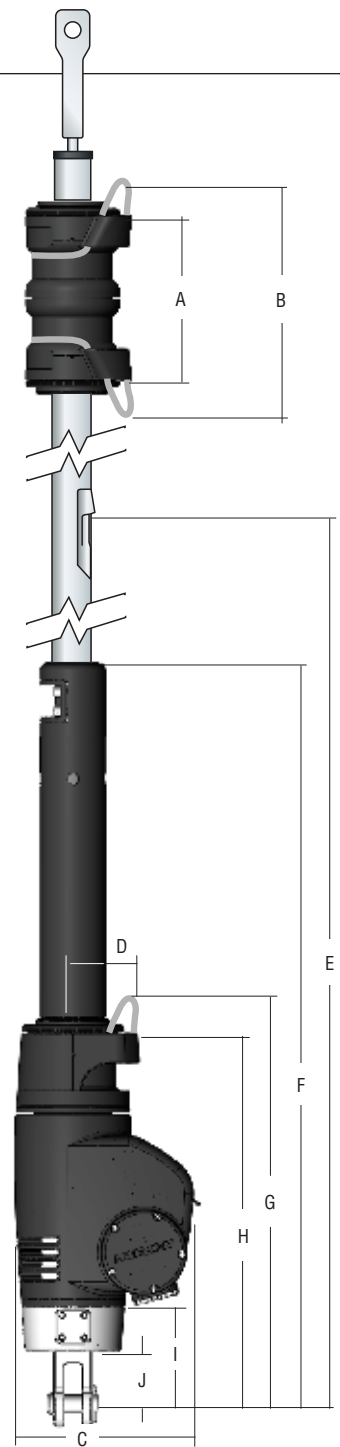
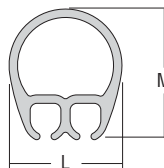

Furling Lead Blocks

Harken recommends equipping jib reefing and asymmetric/code zero furling systems with lead blocks for safe furling from the cockpit. Lightweight, UV-stabilized Carbo blocks run exclusively on ball bearings for fast trimming under any load. Furling leads are offered separately or in complete kits.

MKIV and ESP Jib Reefing and Furling Leads

A 57 mm Carbo ratchet maintains tension on the line so the unit furls smoothly and easily. The outboard assembly allows the line to travel outside of the stanchions, keeping the sidedecks clear. Inboard block assemblies are available for the bow pulpit, to handle two lines, for continuous line furlers, or for cutter-rigged boats with two furlers. Ball and socket bases align blocks for smooth leads aft.

Reflex Asymmetric and Code Zero Furling Leads

Two stanchion leads forward guide line outboard to keep sidedecks clear. A stanchion lead aft features a double Harken Cam-Matic for cleating continuous furling line. A Carbo T2 block with shockcord attaches aft of the double cam to keep line in place for easy access.



MKIV & ESP JIB REEFING & FURLING LEADS

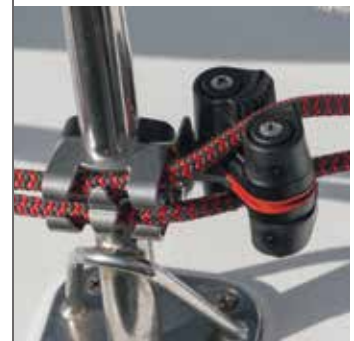

Outboard leads allow furling line to travel outboard of the stanchion to keep the sidedeck clear.



REFLEX ASYMMETRIC & CODE ZERO FURLING LEADS

Part No.	Description	Sheave Ø		Weight		Max line Ø		Maximum working load		Use with
		in	mm	oz	g	in	mm	lb	kg	
MKIV & ESP										
7401	40 mm Carbo lead block assembly	1 9/16	40	3.7	106	3/8	10	485	220	25 mm (1") stanchions
7402	57 mm Carbo ratchet lead block assembly	2 1/4	57	5.4	152	3/8	10	500	227	25 mm (1") stanchions
7403	29 mm outboard lead block assembly	1 1/8	29	3	85	3/8	10			25 mm (1") stanchions
7404	Lead block kit*			19.2	544	3/8	10			25 mm (1") stanchions
7405	40 mm Carbo stanchion mount double lead	1 9/16	40	5.6	159	3/8	10	485	220	25 mm (1") stanchions
7407	57 mm Carbo lead block	2 1/4	57	5.2	149	3/8	10	500	227	25 mm (1") stanchions
Reflex										
7355	Outboard fairlead			4.35	123	3/8	10			25 mm (1") stanchions
7356	Lead block kit**			26.54	751	3/8	10			25 mm (1") stanchions
7359	Outboard fairlead/double cam cleat			9.79	276	3/8	10			25 mm (1") stanchions
7360	57 mm T2 lead block/bungee	2 1/4	57	3.7	106	3/8	10	500	227	

*Kit includes 3 x 7403 / 1 x 7401 / 1 x 7402 / 1 cleat.

**Kit includes 2 x 7355 / 1 x 7359 / 1 x 7360.

Furling Accessories

Harken offers halyard restrainers and halyard deflectors. The halyard restrainer installs on the mast near the top of the foil to keep the line against the mast, preventing halyard wrap when furling. The halyard deflector installs on the stay above the foil system, preventing the jib halyard (and additional halyards) from wrapping around the foil.

Also available are stanchion-mount bases for Carbo and Classic blocks, as well prefeeders and snap shackles to facilitate fast sail changes.



Antares 44i; 13.41 m (44'), Antares Yachts, naval architect: Ted Clements © Salwa Farah / Antares Yachts



947



7006



891



884

885

448



061



7408



944

945



7301, 7302

7303, 7304



7430



7431

Part No.	Description	Sheave Ø		Weight		Max line Ø		Maximum working load		Use with
		in	mm	oz	g	in	mm	lb	kg	
061	Stanchion mount base*			2	57			350	159	22, 25 mm (7/8", 1") stanchions
448	Halyard lead block	1 1/2	38	2.1	60	3/8	10	300	136	0/1/2
884	Snap shackle			2.3	65			1500	680	00AL, MKIV 0/1
885	Snap shackle			5	141			2300	1040	MKIV 2
891	Small Boat furling snap shackle			2.3	65			950	431	163, 165, 1134, 434, 435, 483
944	Halyard restrainer**	15/16	25	3	85					00AL/0/1
945	Halyard restrainer**	1 1/4	31	6	170					2/3/3.25
7301	Halyard deflector			1.6	45					MKIV and ESP Unit 0
7302	Halyard deflector			2.4	68					MKIV and ESP Unit 1
7303	Halyard deflector			4.8	136					MKIV and ESP Unit 2
7304	Halyard deflector			8	227					MKIV and ESP Unit 3
947	Prefeeder			1	28					All
7006	Carbo racing foil prefeeder			3	85					All
7408	Stanchion mount base			2	57			350	159	28.5 mm (1 1/8") stanchions
7430	Powered furling crank handle			7	198					Electric/hydraulic furling
7431	Powered furling drill adapter			2.5	71					Electric/hydraulic furling

*Stanchion mount base fits Classic Bullet, Big Bullet, 2.25", 57 mm Carbo single blocks, and ratchet blocks with swivel post. **#10 RH (5 mm) fasteners.

WINCHES

NEW FOR 2020



SnubbAir
SEE PAGE 192



**CLR Mooring
Winches**
SEE PAGE 208



SnubbAir

It looks like a winch. It mounts like a winch. It cranks like a winch. It's not a winch.

First designed to solve a deck layout challenge unique to the J/70, the Harken SnubbAir might look like a smaller, more efficient version of the winch it replaces. But the product has so many potential applications it defies classification as a winch.

It could act more like a really large ratcheting foot, cheek block, or even a ratcheting line diverter in the pit. The SnubbAir provides lots of line-holding power even without a winch handle. That muscle could become very popular on an A Scow or a powered-up sport boat where the spinnakers can be more than a handful. Even better, you can just flip the sheet off the drum and jibe. If you need even more holding power, wrap the sheet around the SnubbAir twice or use a winch handle with the optional adapter.

SnubbAir comes with four integral threaded studs placed to precisely match the bolt pattern of the B8A winch on the J/70 deck. Start-to-finish, swapping out winches for SnubbAirs takes less than 10 minutes. All washers and Nylok® nuts required for mounting are included.



Installation video



Use the optional winch handle adapter to crank the SnubbAir like a winch.



The SnubbAir is smaller and lighter than the winch it replaces.



J/70 © J/Boats



1300



1301

Handle Adapter

Part No.	Description	Weight		Use with
		oz	g	
1301	Winch handle adapter	1.8	51	1300

SnubbAir

Part No.	Description	Drum Ø		Base Ø		Height		Weight		Fastener circle		Fasteners	Maximum holding load	
		in	mm	in	mm	in	mm	oz	g	in	mm		lb	kg
1300	SnubbAir	3.12	79.2	4.48	113.8	2.71	68.8	17.3	489	3.57	90.7	4 x M6	1000	454

Nylok is a registered trademark of Nylok Corporation.

Ordering Winches

1. Choose Drum Material, Speed & Style

Aluminum: aluminum Radial winches in 1-, 2-, and 3-speed self-tailing or plain-top.

Aluminum classic single-speed, plain-top winches in sizes 6 and 8; 2- and 3-speed self-tailing winches sizes 980 and up in aluminum or aluminum/stainless.

Chrome: Chrome Radial winches feature chrome drums with black or white composite bases and tops; 1-, 2-, and 3-speed self-tailing.

All-chrome Radial winches have chrome bases, drums, and tops; 1-, 2- and 3-speeds; self-tailing or plain-top.

Stainless Steel: stainless steel winches have stainless bases, drums, and tops; 2-, and 3-speed self-tailing; 4-speed winches in some larger sizes.

Bronze: bronze Radial winches in 1-, 2-, and 3-speeds; self-tailing or plain-top styles.

Carbon Fiber: carbon fiber winches in 2- and 3-speed self-tailing or top-cleating.

To order large cruising, Megayacht, and Grand Prix racing winches, please contact Harken.

Powered Winches: choose electric or hydraulically driven winches and components. To order hydraulic winches, please contact Harken.

2. Determine size

The **Sizing Chart** selects winches for different applications and rig dimensions. If unsure of the dimensions, use the **Typical Dimensions** graphs. To order large Grand Prix and Megayacht winches, please contact Harken.

3. Choose Ball Bearing Handle

Plain or lock-in handles in chromed bronze, bronze, and aluminum; Speedgrip and standard styles in 203 and 254 mm (8 and 10") lengths.

Rig Dimensions

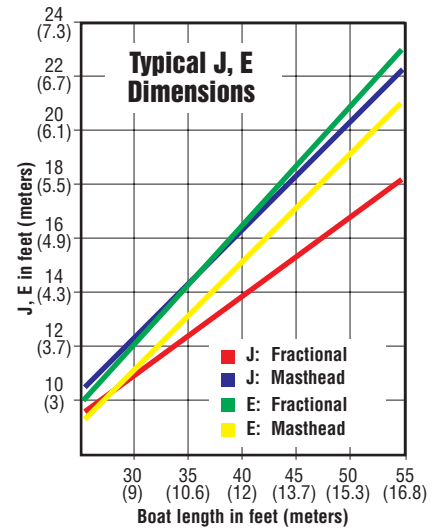
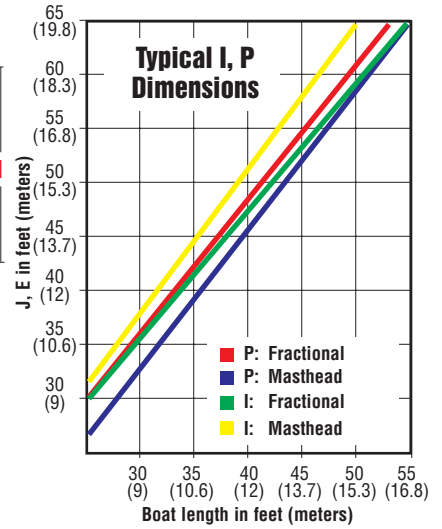
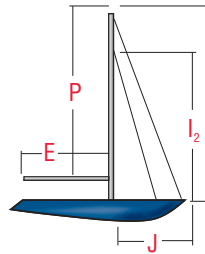

Sizing Chart

Winch size	Genoa				Mainsail						Spinnaker						Staysail	
	Sheet		Halyard		End-boom mainsheet		Halyard		Reef		Sheet		Halyard		Topping lift/foreguy		Halyard	
	Max sail area 100% foretriangle (I x J x .5)		Max I		4:1 sheet max sail area (P x E x .5)		Max P		Max P		Max sail area (I x J x 1.8)		Max I		Max I		Max I ₂	
	ft ²	m ²	ft	m	ft ²	m ²	ft	m	ft	m	ft ²	m ²	ft	m	ft	m	ft	m
6	75	7	25	7.6	—	—	25	7.6	34	10.4	500	46.5	25	7.6	35	10.7	25	7.6
8	115	10.5	36	11	150	14	32	9.8	40	12.2	800	74	36	11	44	13.4	37	11.3
15	135	12.5	39	12	194	18	34	10.5	43	13	893	83	39	12	47	14.2	39	12
20	155	14.5	42	12.8	230	21	38	11.6	46	14	975	91	42	12.8	50	15.2	42	12.8
35	225	21	48	14.6	335	30	43	13.1	53	16.2	1135	105	48	14.6	56	17	48	14.6
40	270	25	54	16.5	410	38	49	14.9	57	17.4	1240	115	54	16.5	61	18.6	54	16.5
46	365	34	69	21	625	58	64	19.5	73	22.2	1530	142	68	20.7	78	23.8	69	21
50	390	36	73	22.2	700	65	68	20.7	78	23.8	1750	162	74	22.5	82	25	73	22.2
60	525	49	82	25	850	79	80	24.4	92	28	2200	204	85	25.9	98	29.9	82	25
70	590	55	86	26.2	1000	93	85	25.9	97	29.6	3000	279	91	27.7	108	33	86	26.2
80	950	88	100	30.5	1350	125	102	31.1	—	—	—	—	105	32	—	—	—	—





RADIAL LINE WINCHES

Harken Radial Line winches have successfully balanced the need for a secure grip and line longevity with smooth, controlled easing while under load. Details sailors will appreciate: smaller winches that carry higher loads, stress-free seasonal maintenance, and one-person installation with easy upgrades to power. Nine sizes in multiple styles and finishes: aluminum, chrome, and bronze; 1-, 2-, and 3-speed self-tailing; manual, electric, or hydraulic drives.



Maximum holding power with minimum line wear

- Nonabrasive diagonal ribs on gripping surface hold line securely and reduce line wear; ribs shaped for each winch size and drum material.

Smooth, controlled easing

- Patented angle of ribs drives line wraps down when easing to keep them on area of drum that provides best control.

High-strength, lightweight

- Weight savings of 25 to 50 percent compared to Harken Classic winch line.
- High-strength composite roller bearings and bushings reduce friction under load.
- Load-carrying gears and pins are 17-4 PH stainless steel for strength, corrosion resistance.

DO NOT use Harken equipment for human suspension unless product is specifically certified and labeled for such use.



Adjustable stripper arm integrated into winch top for safer operation

- Stripper arm completely covers rotating winch top, preventing fingers and clothing from catching in moving parts.
- Adjusts to multiple positions after the winch is mounted to optimize line exit.
- Shaped to smoothly feed line in and out of self-tailing jaws.



Power-grip jaws shaped for easy line entry, optimum hold

- Upper jaw adjusts under line pressure; accepts a variety of line sizes.
- Teeth grip evenly with or without load.



Simple to install, easy maintenance

- Patented mounting system for fast, one-person installation without removing drum.
 - a. Snap off the skirt at the base of the winch.
 - b. Slide bolts through the slots in the winch base and snap the plastic skirt back on.
 - c. Place the stud bolts into the predrilled holes on the deck and tighten from belowdeck.
- Snap-fit design keeps bearings captive when drum is removed for maintenance.
- Easy to disassemble for service on deck; socket, washer, and screw-top snap-fit together for mistake-free reassembly.
- Composite roller bearings don't require lubrication.



Powered Options

- Electric: vertical-mount motors; horizontal-mount motors offered with right- or left-mount option.
- Hydraulic: vertical-mount motor.

Easy upgrade from manual to power

- Manual winches easily convert to powered using patented conversion method.
- No adapter plate required; identical stud pattern to mount winches of the same size without drilling new holes in deck.

- A predrilled hole in deck by builder simplifies manual-to-electric conversion; removable gaskets offered to seal holes until upgrade is made.

Energy-efficient motors accomplish more work per unit of electricity consumed

- Motors attach to central drive shaft and drive through winch gears for two-speed mechanical advantage.
- Low-power first gear for fast trimming; higher-power second gear for fine-tuning loaded sheets.

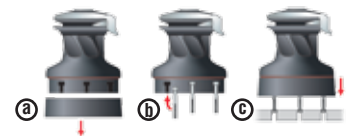

- Efficient design allows smaller motor size.

Manual override in case of power loss

- Harken locking handle inserted into an unloaded winch automatically disconnects motor gear for manual operation.



Aluminum & Chrome Radial Winches

About Radial winches: see feature pages at beginning of this section.



Series 15 and 20 winches use composite bushings to handle high loads in a small package.

WINCH Q&A

WHY DOES MY CHROME RADIAL LINE WINCH HAVE A DIFFERENT GRIP PATTERN THAN AN ALUMINUM RADIAL LINE WINCH?

Chrome has a more slippery finish than aluminum, so the ribs on chrome winches are spaced closer together to increase friction. This optimizes your grip for trimming as well as for easing the sail in a smooth, controlled manner.



ALUMINUM RADIAL



CHROME RADIAL

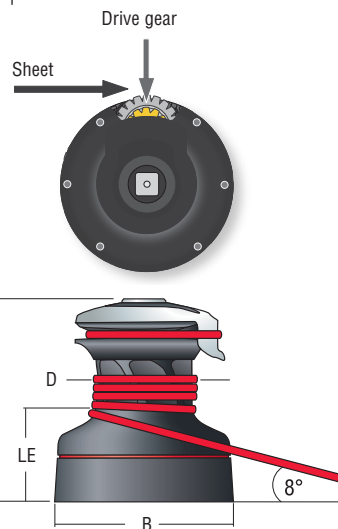

Part No.	Drum (D)		Base (B)		Height (H)		Weight		Line entry height (LE)		Line Ø		Fastener circle	Fasteners (SH or HH)		Gear ratio			Power ratio			
	in	mm	in	mm	in	mm	lb	kg	in	mm	Min	Max		in	mm	in	mm	1	2	3	1	2
Aluminum Radial																						
15STA	2 7/8	73	4 3/4	120	5 1/2	139	4.6	2.1	2 1/4	58	1/4	6	3/8	10	3 15/16	100	5 x 1/4*	5 x 6	2.43			16.90
20STA	2 7/8	73	5 3/8	137	5 13/16	148	5.3	2.4	2 3/8	61	1/4	6	1/2	12	4 3/8	110	5 x 1/4*	5 x 6	2.76			19.20
35.2STA	3 1/8	80	5 7/8	149	6 11/16	170	7.9	3.6	3 1/8	79	5/16	8	1/2	12	4 7/8	123	5 x 1/4*	5 x 6	2.13	5.65		13.50 35.90
40.2STA	3 1/8	80	6 3/16	157	6 7/8	175	8.4	3.8	3 1/4	82	5/16	8	1/2	12	4 7/8	123	5 x 1/4*	5 x 6	2.13	6.28		13.50 39.90
46.2STA	3 7/8	100	7 1/4	184	7 15/16	201	11.5	5.2	3 9/16	90	5/16	8	9/16	14	5 7/8	150	5 x 5/16	5 x 8	2.30	9.17		11.70 46.50
50.2STA	4 5/16	110	7 5/8	194	8 5/16	212	13.2	6	3 7/8	97	5/16	8	9/16	14	5 7/8	150	5 x 5/16	5 x 8	2.40	10.90		10.90 50.40
60.2STA	4 3/4	120	9 5/16	236	9 11/16	246	22.5	10.2	4 9/16	116	5/16	8	5/8	16	8	204	6 x 5/16	6 x 8	4.80	14.40		20.30 61.00
60.3STA	4 3/4	120	9 5/16	236	9 11/16	246	25.8	11.7	4 9/16	116	5/16	8	5/8	16	8	204	6 x 5/16	6 x 8	2.20	4.80	14.40	9.20 20.30 61.00
70.2STA	5 1/8	130	9 7/16	240	10 1/16	256	24.9	11.3	4 1/2	115	3/8	10	11/16	18	8 1/8	205	6 x 5/16	6 x 8	5.70	18.50		22.20 72.00
70.3STA	5 1/8	130	9 7/16	240	10 1/16	256	28.3	12.8	4 1/2	115	3/8	10	11/16	18	8 1/8	205	6 x 5/16	6 x 8	2.30	5.70	18.50	9.00 22.20 72.00
80.2STA	6 7/8	175	11 5/16	287	12 9/16	320	46.8	21.2	6 7/16	164	3/8	10	11/16	18	9 3/16	233	8 x 3/8	8 x 10	9.94	32.12		28.85 93.24
80.3STA	6 7/8	175	11 5/16	287	12 9/16	320	50.1	22.7	6 7/16	164	3/8	10	11/16	18	9 3/16	233	8 x 3/8	8 x 10	2.76	9.94	32.12	8.01 28.85 93.24
Chrome Radial																						
20STC	2 7/8	73	5 3/8	137	5 13/16	148	7.5	3.4	2 3/8	61	1/4	6	1/2	12	4 3/8	110	5 x 1/4*	5 x 6	2.76			19.20
35.2STC	3 1/8	80	5 7/8	149	6 11/16	170	10.6	4.8	3 1/8	79	5/16	8	1/2	12	4 7/8	123	5 x 1/4*	5 x 6	2.13	5.65		13.50 35.90
40.2STC	3 1/8	80	6 3/16	157	6 7/8	175	11.9	5.4	3 1/4	82	5/16	8	1/2	12	4 7/8	123	5 x 1/4*	5 x 6	2.13	6.28		13.50 39.90
46.2STC	3 7/8	100	7 1/4	184	7 15/16	201	17.2	7.8	3 9/16	90	5/16	8	9/16	14	5 7/8	150	5 x 5/16	5 x 8	2.30	9.17		11.70 46.50
50.2STC	4 5/16	110	7 5/8	194	8 5/16	212	20.3	9.2	3 7/8	97	5/16	8	9/16	14	5 7/8	150	5 x 5/16	5 x 8	2.40	10.90		10.90 50.40
60.2STC	4 3/4	120	9 5/16	236	9 11/16	246	30.7	13.9	4 9/16	116	5/16	8	5/8	16	8	204	6 x 5/16	6 x 8	4.80	14.40		20.30 61.00
60.3STC	4 3/4	120	9 5/16	236	9 11/16	246	34	15.4	4 9/16	116	5/16	8	5/8	16	8	204	6 x 5/16	6 x 8	2.20	4.80	14.40	9.20 20.30 61.00
70.2STC	5 1/8	130	9 7/16	240	10 1/16	256	33.3	15.1	4 1/2	115	3/8	10	11/16	18	8 1/8	205	6 x 5/16	6 x 8	5.70	18.50		22.20 72.00
70.3STC	5 1/8	130	9 7/16	240	10 1/16	256	36.6	16.6	4 1/2	115	3/8	10	11/16	18	8 1/8	205	6 x 5/16	6 x 8	2.30	5.70	18.50	9.00 22.20 72.00
80.2STC	6 7/8	175	11 5/16	287	12 9/16	320	63.4	28.7	6 7/16	164	3/8	10	11/16	18	9 3/16	233	8 x 3/8	8 x 10	9.94	32.12		28.85 93.24
80.3STC	6 7/8	175	11 5/16	287	12 9/16	320	66.7	30.2	6 7/16	164	3/8	10	11/16	18	9 3/16	233	8 x 3/8	8 x 10	2.76	9.94	32.12	8.01 28.85 93.24

*SH only

White & All-Chrome Radial Winches

About Radial winches: see feature pages at beginning of this section.



B6CCA
B8CCA

CLASSIC PLAIN-TOP CHROME



Polar Bear, 8.36 m (27.43'), Chantier des Ileaux, naval architect: Paolo Bua © Valerie Lanata



WHITE RADIAL



ALL-CHROME RADIAL

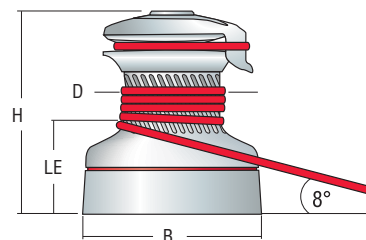
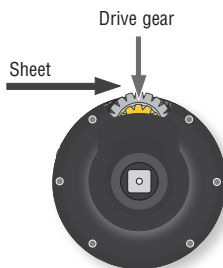

Part No.	Drum (D)		Base (B)		Height (H)		Weight		Line entry height (LE)		Line Ø				Fastener circle		Fasteners (SH or HH)		Gear ratio			Power ratio			
	in	mm	in	mm	in	mm	lb	kg	in	mm	Min	Max	in	mm	in	mm	in	mm	1	2	3	1	2	3	
Chrome Classic: plain-top																									
B6CCA	2 3/8	60	3 9/16	90	3 1/4	82	2.9	1.3	1 5/16	33						2 9/16	65	6 x 1/4**	6 x 6**	1				8.4	
B8CCA	2 11/16	68	4 1/2	115	3 9/16	90	4.6	2.1	1 1/2	38						3 9/16	90	4 x 5/16**	4 x 8**	1				7.5	
White Radial: self-tailing																									
20STCW	2 7/8	73	5 3/8	137	5 13/16	148	7.5	3.4	2 3/8	61	1/4	6	1/2	12	4 3/8	110	5 x 1/4*	5 x M6	2.76					19.20	
35.2STCW	3 1/8	80	5 7/8	149	6 11/16	170	10.6	4.8	3 1/8	79	5/16	8	1/2	12	4 7/8	123	5 x 1/4*	5 x M6	2.13	5.65				13.50	35.90
40.2STCW	3 1/8	80	6 3/16	157	6 7/8	175	11.9	5.4	3 1/4	82	5/16	8	1/2	12	4 7/8	123	5 x 1/4*	5 x M6	2.13	6.28				13.50	39.90
46.2STCW	3 7/8	100	7 1/4	184	7 15/16	202	17.2	7.8	3 9/16	90	5/16	8	9/16	14	5 7/8	150	5 x 5/16	5 x M8	2.30	9.17				11.70	46.50
50.2STCW	4 5/16	110	7 5/8	194	8 5/16	212	20.3	9.2	3 7/8	97	5/16	8	9/16	14	5 7/8	150	5 x 5/16	5 x M8	2.40	10.90				10.90	50.40
60.2STCW	4 3/4	120	9 5/16	236	9 11/16	246	30.7	13.9	4 9/16	116	5/16	8	5/8	16	8	204	6 x 5/16	6 x M8	4.80	14.40				20.30	61.00
60.3STCW	4 3/4	120	9 5/16	236	9 15/16	253	34	15.4	4 9/16	116	5/16	8	5/8	16	8	204	6 x 5/16	6 x M8	2.20	4.80	14.40	9.20	20.30	61.00	
70.2STCW	5 1/8	130	9 7/16	240	10 1/16	256	33.3	15.1	4 1/2	115	3/8	10	11/16	18	8 1/8	205	6 x 5/16	6 x M8	5.70	18.50				22.20	72.00
70.3STCW	5 1/8	130	9 7/16	240	10 3/8	264	36.6	16.6	4 1/2	115	3/8	10	11/16	18	8 1/8	205	6 x 5/16	6 x M8	2.30	5.70	18.50	9.00	22.20	72.00	
All-Chrome Radial: plain-top																									
20.2PTCCC	2 7/8	73	5 3/8	137	5 1/16	128	7.9	3.6	2 3/8	61						4 3/8	110	5 x 1/4*	5 x M6	1.00	2.76			6.95	19.20
35.2PTCCC	3 1/8	80	5 7/8	149	5 13/16	148	11.5	5.2	3 1/8	79	5/16	8	1/2	12	4 7/8	123	5 x 1/4*	5 x M6	2.13	5.65				13.50	35.90
40.2PTCCC	3 1/8	80	6 3/16	157	6	153	13.5	6.1	3 1/4	82						4 7/8	123	5 x 1/4*	5 x M6	2.13	6.28			13.50	39.90
46.2PTCCC	3 7/8	100	7 1/4	184	7 1/16	179	21.4	9.7	3 9/16	90						5 7/8	150	5 x 5/16	5 x M8	2.30	9.17			11.70	46.50
50.2PTCCC	4 5/16	110	7 5/8	194	7 1/2	190	25.6	11.6	3 7/8	97						5 7/8	150	5 x 5/16	5 x M8	2.40	10.90			10.90	50.40
All-Chrome Radial: self-tailing																									
20STCCC	2 7/8	73	5 3/8	137	5 13/16	148	8.6	3.9	2 3/8	61	1/4	6	1/2	12	4 3/8	110	5 x 1/4*	5 x M6	2.76					19.20	
35.2STCCC	3 1/8	80	5 7/8	149	6 11/16	170	12.1	5.5	3 1/8	79	5/16	8	1/2	12	4 7/8	123	5 x 1/4*	5 x M6	2.13	5.65				13.50	35.90
40.2STCCC	3 1/8	80	6 3/16	157	6 7/8	175	13.7	6.2	3 1/4	82	5/16	8	1/2	12	4 7/8	123	5 x 1/4*	5 x M6	2.13	6.28				13.50	39.90
46.2STCCC	3 7/8	100	7 1/4	184	7 15/16	202	19.6	8.9	3 9/16	90	5/16	8	9/16	14	5 7/8	150	5 x 5/16	5 x M8	2.30	9.17				11.70	46.50
50.2STCCC	4 5/16	110	7 5/8	194	8 5/16	212	22.9	10.4	3 7/8	97	5/16	8	9/16	14	5 7/8	150	5 x 5/16	5 x M8	2.40	10.90				10.90	50.40
60.2STCCC	4 3/4	120	9 5/16	236	9 11/16	246	33.9	15.4	4 9/16	116	5/16	8	5/8	16	8	204	6 x 5/16	6 x M8	4.80	14.40				20.30	61.00
60.3STCCC	4 3/4	120	9 5/16	236	9 3/8	253	37.3	16.9	4 9/16	116	5/16	8	5/8	16	8	204	6 x 5/16	6 x M8	2.20	4.80	14.40	9.20	20.30	61.00	
70.2STCCC	5 1/8	130	9 7/16	240	10 1/16	256	36.8	16.7	4 1/2	115	3/8	10	11/16	18	8 1/8	205	6 x 5/16	6 x M8	5.70	18.50				22.20	72.00
70.3STCCC	5 1/8	130	9 7/16	240	10 3/8	264	40.1	18.2	4 1/2	115	3/8	10	11/16	18	8 1/8	205	6 x 5/16	6 x M8	2.30	5.70	18.50	9.00	22.20	72.00	

*SH only. **FH only.

Bronze Radial Winches

About Radial winches: see feature pages at beginning of this section.



Sakonnet 23, 7.06 m (23'2"), Marshall Marine Corp., naval architect: Joel White © Kristen Marshall / Marshall Marine Corp.



B6BBA
B8BBA

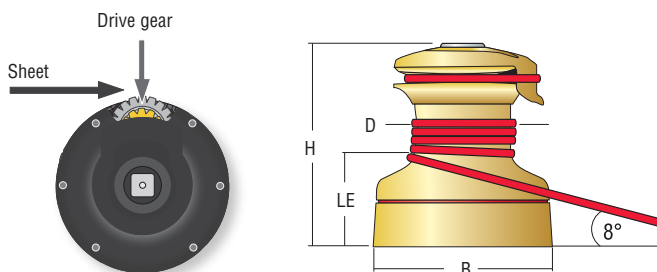

Part No.	Drum (D)		Base (B)		Height (H)		Weight		Line entry height (LE)		Line Ø		Fastener circle		Fasteners (SH or HH)		Gear ratio			Power ratio				
	in	mm	in	mm	in	mm	lb	kg	in	mm	in	mm	in	mm	in	mm	1	2	3	1	2	3		
Bronze Classic: plain-top																								
B6BBA	2 3/8	60	3 9/16	90	3 1/4	82	2.9	1.3	1 5/16	33			2 9/16	65	6 x 1/4**	6 x 6**	1					8.4		
B8BBA	2 11/16	68	4 1/2	115	3 9/16	90	4.6	2.1	1 1/2	38			3 9/16	90	4 x 5/16**	4 x 8**	1					7.5		
Bronze Radial: plain-top																								
20.2PTBBB	2 7/8	73	5 3/8	137	5 1/16	128	7.9	3.6	2 3/8	61			4 3/8	110	5 x 1/4*	5 x M6	1	2.76			6.95	19.20		
35.2PTBBB	3 1/8	80	5 7/8	149	5 13/16	148	11.5	5.2	3 1/8	79			4 7/8	123	5 x 1/4*	5 x M6	2.13	5.65			13.50	35.90		
40.2PTBBB	3 1/8	80	6 3/16	157	6	153	13.5	6.1	3 1/4	82			4 7/8	123	5 x 1/4*	5 x M6	2.13	6.28			13.50	39.90		
46.2PTBBB	3 7/8	100	7 1/4	184	7 1/16	179	21.4	9.7	3 9/16	90			5 7/8	150	5 x 5/16	5 x M8	2.30	9.17			11.70	46.50		
50.2PTBBB	4 5/16	110	7 5/8	194	7 1/2	190	25.6	11.6	3 7/8	97			5 7/8	150	5 x 5/16	5 x M8	2.40	10.90			10.90	50.40		
Bronze Radial: self-tailing																								
20STBBB	2 7/8	73	5 3/8	137	5 13/16	148	8.6	3.9	2 3/8	61	1/4	6	1/2	12	4 3/8	110	5 x 1/4*	5 x M6	2.76			19.20		
35.2STBBB	3 1/8	80	5 7/8	149	6 11/16	170	12.1	5.5	3 1/8	79	5/16	8	1/2	12	4 7/8	123	5 x 1/4*	5 x M6	2.13	5.65		13.50	35.90	
40.2STBBB	3 1/8	80	6 3/16	157	6 7/8	175	13.7	6.2	3 1/4	82	5/16	8	1/2	12	4 7/8	123	5 x 1/4*	5 x M6	2.13	6.28		13.50	39.90	
46.2STBBB	3 7/8	100	7 1/4	184	7 15/16	202	19.6	8.9	3 9/16	90	5/16	8	9/16	14	5 7/8	150	5 x 5/16	5 x M8	2.30	9.17		11.70	46.50	
50.2STBBB	4 5/16	110	7 5/8	194	8 5/16	212	22.9	10.4	3 7/8	97	5/16	8	9/16	14	5 7/8	150	5 x 5/16	5 x M8	2.40	10.90		10.90	50.40	
60.2STBBB	4 3/4	120	9 5/16	236	9 11/16	246	33.9	15.4	4 9/16	116	5/16	8	5/8	16	8	204	6 x 5/16	6 x M8	4.80	14.40		20.30	61.00	
60.3STBBB	4 3/4	120	9 5/16	236	9 3/8	253	37.3	16.9	4 9/16	116	5/16	8	5/8	16	8	204	6 x 5/16	6 x M8	2.20	4.80	14.40	9.20	20.30	61.00
70.2STBBB	5 1/8	130	9 7/16	240	10 1/16	256	36.8	16.7	4 1/2	115	3/8	10	11/16	18	8 1/8	205	6 x 5/16	6 x M8	5.70	18.50		22.20	72.00	
70.3STBBB	5 1/8	130	9 7/16	240	10 3/8	264	40.1	18.2	4 1/2	115	3/8	10	11/16	18	8 1/8	205	6 x 5/16	6 x M8	2.30	5.70	18.50	9.00	22.20	72.00

*SH only. **FH only.

Electric & Hydraulic Motors

Specify power type, material, voltage, and motor configuration when ordering. See part number explanation.

About Radial winches: see feature pages at beginning of this section.

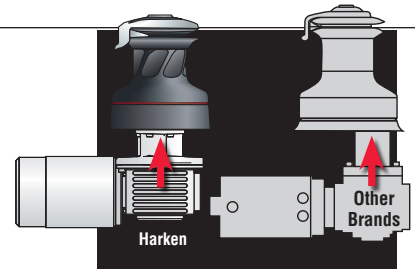

Harken electric and hydraulic motors attach to the central drive shaft and drive through the winch gears for a two-speed mechanical advantage—the low-power first gear for fast trimming, the higher-power second gear for fine-tuning loaded sheets. This results in reduced battery drain and a more efficient motor on the electric version. The energy-efficient hydraulic version is also smaller, reducing weight and cost.

Dimensions

Part No.	E		F		G		L		N		A		Weight C		BBB/CCC		
	in	mm	in	mm	in	mm	in	mm	in	mm	lb	kg	lb	kg	lb	kg	
Electric																	
35.2STE	1 3/4	43	6 1/8	155	8 7/8	227						29.3	13.3	32	14.5	33.5	15.2
40.2STE	1 3/4	43	6 1/8	155	8 7/8	227						29.7	13.5	33.2	15.1	35	15.9
46.2STE	1 3/4	43	6 1/8	155	8 7/8	227						32.8	14.9	38.5	17.5	41	18.6
46.2STEV							15 3/8	391	6 1/8	157		36.9	16.7	42.6	19.3	45	20.4
50.2STE	2 3/4	69	7 1/8	181	9 5/8	244						37.1	16.8	44.2	20	46.7	21.2
50.2STEV							15 3/8	391	6 1/8	157		38.6	17.5	45.7	20.7	48.3	21.9
60.2STE	2 3/4	69	7 1/8	181	9 5/8	244						46.4	21	54.5	24.7	57.8	26.2
60.2STEV							15 3/8	391	6 1/8	157		47.9	21.7	56.1	25.4	59.3	26.9
60.3STE	2 3/4	69	7 1/8	181	9 5/8	244						49.7	22.5	57.8	26.2	61	27.7
60.3STEV							15 3/8	391	6 1/8	157		51.2	23.2	59.4	26.9	62.6	28.4
70.2STE	2 3/4	69	7 1/8	181	9 5/8	244						48.8	22.1	57.2	25.9	60.6	27.5
70.2STEV							15 3/8	391	6 1/8	157		50.3	22.8	58.7	26.6	62.2	28.2
70.3STE	2 3/4	69	7 1/8	181	9 5/8	244						52.1	23.6	60.5	27.4	63.9	29
70.3STEV							15 3/8	391	6 1/8	157		53.6	24.3	62	28.1	65.5	29.7
80.2STE	3 3/16	81	8 11/16	221	10 11/16	272						70.6	32	87.2	39.5		
80.2STEV							16 13/16	427	6 3/4	172		72.2	32.7	88.7	40.2		
80.3STE	3 3/16	81	8 11/16	221	10 11/16	272						74	33.5	90.5	41		
80.3STEV							16 13/16	427	6 3/4	172		75.5	34.2	92.1	41.7		
Hydraulic																	
46.2STH					9 1/4	234	5 1/8	130				28	12.7	33.8	15.3	36.2	16.4
50.2STH					9 1/4	234	5 1/8	130				29.8	13.5	36.9	16.7	39.5	17.9
60.2STH					9 1/4	234	5 1/8	130				39.1	17.7	47.2	21.4	50.5	22.9
60.3STH					9 1/4	234	5 1/8	130				42.4	19.2	50.6	22.9	53.8	24.4
70.2STH					9 1/4	234	5 1/8	130				41.5	18.8	49.9	22.6	53.4	24.2
70.3STH					9 1/4	234	5 1/8	130				44.8	20.3	53.2	24.1	56.7	25.7
80.2STH					9 7/8	250	5 1/8	130				66.4	30.1	83	37.6		
80.3STH					9 7/8	250	5 1/8	130				69.8	31.6	86.3	39.1		

Winch size	Electric motor configuration		Current voltage		Power in watts	
	Horizontal (STE)	Vertical (STEV)	12V	24V	12V	24V
35.2 - 40.2	✓	—	✓	✓	700	900
46.2	✓	✓	✓	✓	700	900
50.2	✓	✓	✓	✓	1500	2000
60.2 - 60.3	✓	✓	✓	✓	1500	2000
70.2 - 70.3	✓	✓	✓	✓	1500	2000
80.2 - 80.3	✓	✓	✓	✓	1500	2000

Electric Wire Gauges

Winch size	Current voltage	Total distance between winch and battery							
		Under 16.4' AWG	Under 5 m 32.8' mm ²	16.4 - 32.8' 50 mm ²	5 - 10 m 49.2' mm ²	10 - 15 m 49.2' mm ²	15 - 20 m 65.6' mm ²	15 - 20 m 65.6' mm ²	15 - 20 m 65.6' mm ²
35.2 - 40.2	12V	2	32	0	50	00	70	000	95
35.2 - 40.2	24V	5	16	3	25	2	35	0	50
46.2	12V	2	32	0	50	00	70	000	95
46.2	24V	5	16	3	25	2	35	0	50
50.2	12V	2	32	0	50	00	70	000	95
50.2	24V	5	16	3	25	2	35	0	50
60.2 - 60.3	12V	2	32	0	50	00	70	000	95
60.2 - 60.3	24V	5	16	3	25	2	35	0	50
70.2 - 70.3	12V	2	32	0	50	00	70	000	95
70.2 - 70.3	24V	5	16	3	25	2	35	0	50
80.2 - 80.3	12V	2	32	0	50	00	70	000	95
80.2 - 80.3	24V	5	16	3	25	2	35	0	50

Part Numbers

Specify power type, material, voltage, and motor configuration when ordering. Refer to manual self-tailing Radial winch pages for drum and power ratio specifications.

46.2STEC12H

- Winch size
- Number of speeds
- Self-tailing
- Power type
E = Electric
H = Hydraulic
- Material code
A = Aluminum
C = Chrome
CW = Chrome/white
CCC = All-chrome
BBB = Bronze
- Voltage
12 = 12V
24 = 24V
- Motor configuration
Specify electric; hydraulic available in vertical only.
H = Horizontal
V = Vertical

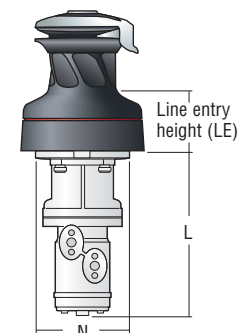
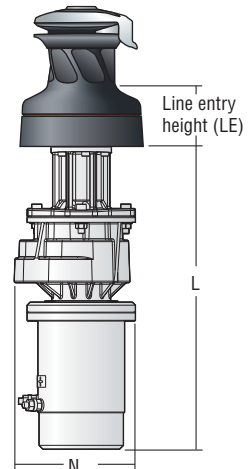
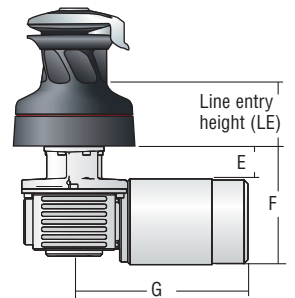

UniPower Winches

The UniPower is a single-speed winch that combines the advantages of a low-profile manual winch with the power of a 12- or 24-volt, low-amp-draw motor. What makes it unique is that the motor is partially imbedded inside the drum, so that it extends only 105 mm (4 1/8") below the winch base—a critical feature for small boats where space under the cabintop is limited.

About Radial winches: see feature pages at beginning of this section.

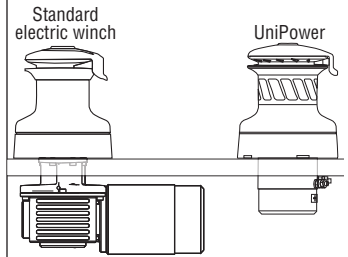

Low-profile electric motor saves headspace.



Eckernförde, Saare 38, 11.40 m, Karl-Johan Stråhlmann, Saare Yachts © Saare Yachts



900UPW



Works with handle if power is unavailable.

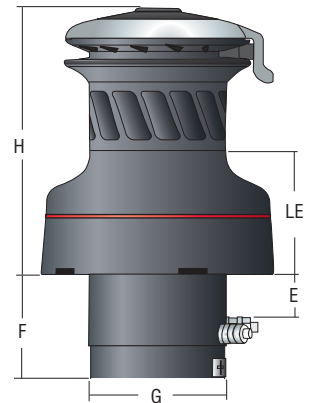

Dimensions

Part No.	Line entry height (LE)		E		F		G	
	in	mm	in	mm	in	mm	in	mm
900UPWA/C/CW/CCC/BBB	3 15/16	100	1 3/8	35	4 1/8	105	5 1/2	140

Part No.	Ø		Base	Height (H)		Weight		Line Ø		Fastener circle		Fasteners (SH or HH)		Max pull				
	in	mm		in	mm	lb	kg	Min	Max	in	mm	in	mm	lb	kg			
900UPWA	4 3/8	110	7 1/2	190	8 1/2	215	26.5	12	5/16	8	9/16	14	6 5/16	160	5 x 5/16	5 x M8	1984	900
900UPWC	4 3/8	110	7 1/2	190	8 1/2	215	32	14.5	5/16	8	9/16	14	6 5/16	160	5 x 5/16	5 x M8	1984	900
900UPWCW	4 3/8	110	7 1/2	190	8 1/2	215	32	14.5	5/16	8	9/16	14	6 5/16	160	5 x 5/16	5 x M8	1984	900
900UPWCCC	4 3/8	110	7 1/2	190	8 1/2	215	34.6	15.7	5/16	8	9/16	14	6 5/16	160	5 x 5/16	5 x M8	1984	900
900UPWBBB	4 3/8	110	7 1/2	190	8 1/2	215	34.6	15.7	5/16	8	9/16	14	6 5/16	160	5 x 5/16	5 x M8	1984	900

Specify voltage when ordering. Harken recommends the single function digital switch DSSBK4 and circuit breaker HCP1717. Sold separately.

Rewind Electric Winches

The Rewind Radial electric winch is the latest in Harken's "easy sailing" solutions for cruisers, and the first winch of its kind in the marine market. Activated remotely by twin in/out buttons, the Rewind safely eases and trims highly-loaded sails in both directions without ever taking the line out of the self-tailer.

Like all Harken electric winches, the Rewind operates like a normal 2-speed electric winch. A simple flip of the red knob on the winch base turns on the rewind feature. A spring-loaded arm of investment-cast stainless steel funnels and keeps line captive as it feeds in and out of the self-tailer as the sail is adjusted with fingertip control.

Available in 12- and 24-volts.

About Radial winches: see feature pages at beginning of this section.



A Harken locking handle inserted into an unloaded winch automatically disconnects the motor gear for manual operation.



Activated remotely by twin in/out buttons, the Rewind winch safely eases and trims highly-loaded sails in both directions without ever taking the line out of the self-tailer.



A simple flip of the red knob on the winch base turns on the rewind feature.

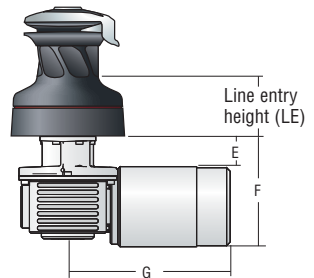

Part No.	Line entry height (LE)		E		F		G	
	in	mm	in	mm	in	mm	in	mm
40RWA/C/CW/CCC/BBB	3 1/4	82	1 3/4	43	6 1/8	155	11	280
46RWA/C/CW/CCC/BBB	3 9/16	90	1 3/4	43	6 1/8	155	11	280
60RWA/C/CW/CCC/BBB	4 9/16	116	2 3/4	69	7 1/8	181	11	280

Part No.	Ø Drum		Ø Base		Height		Weight		Line Ø		Fastener circle		Fasteners (SH or HH)		Gear ratio		Power ratio			
	in	mm	in	mm	in	mm	lb	kg	in	mm	in	mm	in	mm	1	2	1	2		
40RWA	3 1/8	80	6 3/16	157	6 7/8	175	32.2	14.6	5/16	8	1/2	12	4 7/8	123	5 x 1/4	5 x 6	2.13	6.28	13.50	39.90
40RWC/CW	3 1/8	80	6 3/16	157	6 7/8	175	35.7	16.2	5/16	8	1/2	12	4 7/8	123	5 x 1/4	5 x 6	2.13	6.28	13.50	39.90
40RWCCC/BBB	3 1/8	80	6 3/16	157	6 7/8	175	37.5	17	5/16	8	1/2	12	4 7/8	123	5 x 1/4	5 x 6	2.13	6.28	13.50	39.90
46RWA	3 7/8	100	7 1/4	184	8	203	35.3	16	3/8	10	9/16	14	5 7/8	150	5 x 5/16	5 x 8	2.30	9.17	11.70	46.50
46RWC/CW	3 7/8	100	7 1/4	184	8	203	41	18.6	3/8	10	9/16	14	5 7/8	150	5 x 5/16	5 x 8	2.30	9.17	11.70	46.50
46RWCCC/BBB	3 7/8	100	7 1/4	184	8	203	43.4	19.7	3/8	10	9/16	14	5 7/8	150	5 x 5/16	5 x 8	2.30	9.17	11.70	46.50
60RWA	4 3/4	120	9 5/16	236	9 11/16	246	48.7	22.1	9/16	14	5/8	16	8	204	6 x 5/16	6 x 8	4.80	14.40	20.30	61.00
60RWC/CW	4 3/4	120	9 5/16	236	9 11/16	246	56.9	25.8	9/16	14	5/8	16	8	204	6 x 5/16	6 x 8	4.80	14.40	20.30	61.00
60RWCCC/BBB	4 3/4	120	9 5/16	236	9 11/16	246	60.2	27.3	9/16	14	5/8	16	8	204	6 x 5/16	6 x 8	4.80	14.40	20.30	61.00





Swan 65, 20.11 m (65.98'), Germán Frers design © Nautor Swan / Nico Martinez

PERFORMA WINCHES

Harken Performa winches combine the high-efficiency of the Radial line with the sandblasted grip of Harken carbon-fiber racing winches for powerful hybrids. Optimized to handle the high-strength line used on sport-boats and performance cruisers, Performa winches are a great solution for crew who don't wish to invest in carbon winches or who need racing winches in smaller sizes. Winches come in self-tailing, plain-top, or Quattro styles; manual, electric (12- or 24-volt), or hydraulic drives. Available in sizes 20 to 80 to complement Harken's carbon line.



Maximum holding power for high-tech line

- Sandblasted drums and ribs optimized for halyard and sheeting applications using small-diameter, high-strength line.

Trim and ease sails quickly and easily

- Patented angle of ribs drives line wraps down when easing to keep them on area of drum that provides best control.
- Transfer high loads to the winch with fewer wraps.

High-strength, lightweight

- Lightweight aluminum drum features an integrated skirt.
- High-strength composite roller and ball thrust bearings reduce friction under load.
- Load-carrying gears and pins are 17-4 PH stainless steel for strength, corrosion resistance.

DO NOT use Harken equipment for human suspension unless product is specifically certified and labeled for such use.



Quattro model for boats requiring extremely fast winches

- Handles large asymmetrical spinnakers; power to trim genoa upwind.
- 2 speeds + 2 drum diameters = 4 line speeds.



Power-grip jaws shaped for easy line entry, optimum hold

- Narrow composite jaws ensure superior holding power on small-diameter, high-strength line.
- Lower jaw adjusts under line pressure; accepts a variety of line sizes.
- Teeth grip evenly with or without load.



Simple to install, easy maintenance

- Patented mounting system for fast, one-person installation without removing drum.
- Snap-fit design keeps bearings captive when drum is removed for maintenance.
- Easy to disassemble for service on deck; socket, washer, and screw-top snap-fit together for mistake-free reassembly.
- Composite roller bearings don't require lubrication.

Adjustable stripper arm integrated into winch top for safer operation

- Stripper arm completely covers rotating winch top, preventing fingers and clothing from catching in moving parts.
- Adjusts to multiple positions after the winch is mounted to optimize line exit.
- Shaped to smoothly feed line in and out of self-tailing jaws.



Powered Options

- Electric: vertical-mount motors; horizontal-mount motors offered with right- or left-mount option.
- Hydraulic: vertical-mount motor.

Easy upgrade from manual to power

- Manual winches easily convert to powered using patented conversion method.
- No adapter plate required; identical stud pattern to mount winches of the same size without drilling new holes in deck.

- A predrilled hole in deck by builder simplifies manual-to-electric conversion; removable gaskets offered to seal holes until upgrade is made.

Energy-efficient motors accomplish more work per unit of electricity consumed

- Motors attach to central drive shaft and drive through winch gears for two-speed mechanical advantage.
- Low-power first gear for fast trimming; higher-power second gear for fine-tuning loaded sheets.

- Efficient design allows smaller motor size.

Manual override in case of power loss

- Harken locking handle inserted into an unloaded winch automatically disconnects motor gear for manual operation.



Performa Winches

About Performa winches: see feature pages at beginning of this section.

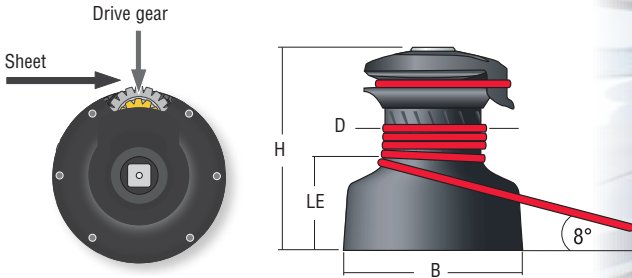

CLASSIC PLAIN-TOP



PLAIN-TOP

Use plain-top winches on sportboats where sails require frequent trimming. Plain-top winches are best handled by two crew—one to trim and one to tail the line.

SELF-TAILING

Self-tailing winches have narrow composite jaws to ensure superior holding power on small-diameter line. The self-tailing mechanism on the winch means that one crew member can quickly and easily trim or raise sails.

QUATTRO

Use Quattro models for boats requiring extremely fast winches. Quattros handle large asymmetrical spinnakers and provide power to trim genoa upwind. 2 speeds + 2 drum diameters = 4 line speeds.

Part No.	Ø		Base (B)	Height (H)	Weight	Line entry height (LE)	Line Ø		Fastener circle	Fasteners (SH or HH)	Gear ratio			Power ratio									
	in	mm					in	mm			in	mm	in	mm	1	2	3	1	2	3			
Classic Plain-Top																							
B6A	2 3/8	60	3 9/16	90	3 1/4	82	1.5	0.7	1 5/16	33	2 9/16	65	6 x 1/4 FH	6 x 6 FH	1			8.4					
B8A	2 11/16	68	4 1/2	115	3 9/16	90	2.4	1.1	1 1/2	38	3 9/16	90	4 x 5/16 FH	4 x 8 FH	1			7.5					
Plain-Top																							
20.2PTP	2 7/8	73	5 3/8	137	5 1/16	128	4.4	2	2 3/8	61	4 3/8	110	5 x 1/4*	5 x M6	1	2.76		6.95	19.2				
35.2PTP	3 1/8	80	5 7/8	149	5 13/16	148	6.8	3.1	3 1/8	79	4 7/8	123	5 x 1/4*	5 x M6	2.13	5.65		13.50	35.90				
40.2PTP	3 1/8	80	6 3/16	157	6	153	7.7	3.5	3 1/4	82	4 7/8	123	5 x 1/4*	5 x M6	2.13	6.28		13.50	39.90				
46.2PTP	3 15/16	100	7 1/4	184	7 1/16	179	11.3	5.1	3 9/16	90	5 7/8	150	5 x 5/16	5 x M8	2.30	9.17		11.70	46.50				
50.2PTP	4 5/16	110	7 11/16	195	7 1/2	190	13	5.9	3 13/16	97	5 7/8	150	5 x 5/16	5 x M8	2.40	10.90		11.10	50.40				
Self-Tailing																							
20STP	2 7/8	73	5 3/8	137	5 13/16	148	5.3	2.4	2 3/8	61	1/4	6 1/2	12	4 3/8	110	5 x 1/4*	5 x M6	2.76			19.20		
35.2STP	3 1/8	80	5 7/8	149	6 11/16	170	7.9	3.6	3 1/8	79	5/16	8 1/2	12	4 7/8	123	5 x 1/4*	5 x M6	2.13	5.65		13.50	35.90	
40.2STP	3 1/8	80	6 3/16	157	6 7/8	175	8.4	3.8	3 1/4	82	5/16	8 1/2	12	4 7/8	123	5 x 1/4*	5 x M6	2.13	6.28		13.50	39.90	
46.2STP	3 15/16	100	7 1/4	184	7 15/16	202	11.5	5.2	3 9/16	90	5/16	8 9/16	14	5 7/8	150	5 x 5/16	5 x M8	2.30	9.17		11.70	46.50	
50.2STP	4 5/16	110	7 11/16	195	8 5/16	212	13.2	6	3 13/16	97	5/16	8 9/16	14	5 7/8	150	5 x 5/16	5 x M8	2.40	10.90		11.10	50.40	
50.3STP	4 5/16	110	7 11/16	195	8 5/16	212	15.0	6.8	3 13/16	97	5/16	8 9/16	14	5 7/8	150	5 x 5/16	5 x M8	1	2.40	10.90	4.62	11.10	50.40
60.2STP	4 3/4	120	9 5/16	236	9 11/16	246	22.5	10.2	4 9/16	116	5/16	8 5/8	16	8	204	6 x 5/16	6 x M8	4.80	14.4		20.30	61.00	
60.3STP	4 3/4	120	9 5/16	236	10	253	25.8	11.7	4 9/16	116	5/16	8 5/8	16	8	204	6 x 5/16	6 x M8	2.20	4.80	14.40	9.20	20.30	61.00
70.2STP	5 1/8	130	9 7/16	240	10 1/16	256	24.9	11.3	4 1/2	115	3/8	10 5/8	16	8 1/8	205	6 x 5/16	6 x M8	5.70	18.50		22.20	72.00	
70.3STP	5 1/8	130	9 7/16	240	10 3/8	264	28.3	12.8	4 1/2	115	3/8	10 5/8	16	8 1/8	205	6 x 5/16	6 x M8	2.30	5.70	18.50	9.00	22.20	72.00
80.2STP	6 7/8	175	11 5/16	287	12 9/16	320	46.8	21.2	6 7/16	164	3/8	10 11/16	18	9 3/16	233	8 x 3/8	8 x M10	9.94	32.12		28.85	93.24	
80.3STP	6 7/8	175	11 5/16	287	12 7/8	327	50.1	22.7	6 7/16	164	3/8	10 11/16	18	9 3/16	233	8 x 3/8	8 x M10	2.76	9.94	32.12	8.01	28.85	93.24
Quattro																							
40STQP	3 1/8**	80**	7 1/8	180	6 7/8	175	10.2	4.6	3 1/4**	82**	5/16	8 1/2	12	4 7/8	123	5 x 1/4*	5 x M6	2.13	6.28		13.50	39.90	
46STQP	3 15/16‡	100‡	8 1/2	218	7 15/16	202	13.7	6.2	3 9/16‡	90‡	5/16	8 9/16	14	5 7/8	150	5 x 5/16	5 x M8	2.30	9.17		11.70	46.50	

*SH only. **Refers to upper drum. Lower drum Ø = 154 mm (6 1/16"); line entry height = 24 mm (15/16").

‡Refers to upper drum. Lower drum Ø = 188 mm (7 13/32"); line entry height = 24 mm (15/16").

Electric and Hydraulic Performa Winches

Electric and hydraulic Performa winches let you trim any size sail with the push of a button.

Specify power type, voltage, and motor configuration when ordering. See part number explanation.

About Performa winches: see feature pages at beginning of this section.

Part Numbers

Specify power type, voltage, and motor configuration when ordering

46.2STEP12HLM

Winch size

Number of speeds

Self-tailing

Power type

E = Electric H = Hydraulic

Performa

P = Performa winch line

Voltage

12 = 12V 24 = 24V

Motor configuration

Specify for electric; hydraulic available in vertical only.

H = Horizontal V = Vertical

Left-mount option

Available in electric only. Additional letter code for left-mount option only; standard mounting part number ends with motor configuration.

LM = Left-mount

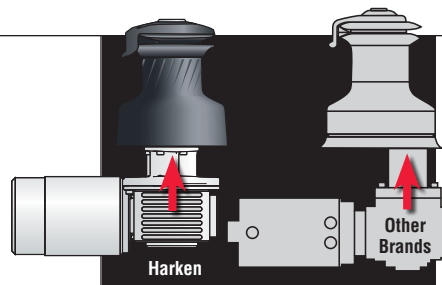

Harken electric and hydraulic motors attach to the central drive shaft and drive through the winch gears for a 2-speed mechanical advantage—the low-power first gear for fast trimming, the higher-power second gear for fine-tuning loaded sheets. This results in reduced battery drain and a more efficient motor on the electric version. The energy-efficient hydraulic version is also smaller, reducing weight and cost.

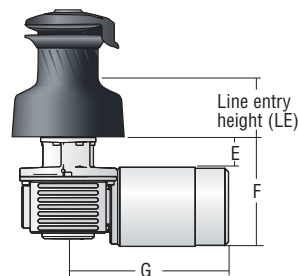

ELECTRIC HORIZONTAL

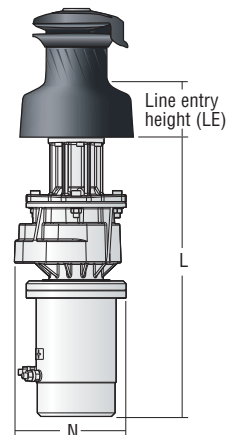

ELECTRIC VERTICAL

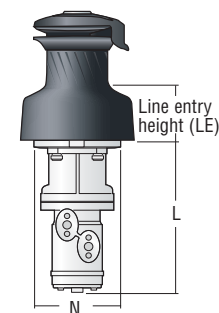

HYDRAULIC

Dimensions

Part No.	Racing disconnect rod*	E		F		G		L		N		Weight with motor		
		in	mm	in	mm	in	mm	in	mm	in	mm	lb	kg	
Electric														
40.2STEPH	B40PDR	1 3/4	43	6 1/8	155	8 7/8	227						29.7	13.5
46.2STEPH	B46PDR	1 3/4	43	6 1/8	155	8 7/8	227						32.8	14.9
46.2STEPV	B46PDR							15 3/8	391	6 1/8	157		36.9	16.7
50.2STEPH	B50PDR	2 3/4	69	7 1/8	181	9 5/8	244						37.1	16.8
50.2STEPV	B50PDR							15 3/8	391	6 1/8	157		38.6	17.5
60.2STEPH	B60PDR	2 3/4	69	7 1/8	181	9 5/8	244						46.4	21
60.2STEPV	B60PDR							15 3/8	391	6 1/8	157		47.9	21.7
60.3STEPH	B60.3PDR	2 3/4	69	7 1/8	181	9 5/8	244						49.7	22.5
60.3STEPV	B60.3PDR							15 3/8	391	6 1/8	157		51.2	23.2
70.2STEPH	B70PDR	2 3/4	69	7 1/8	181	9 5/8	244						48.8	22.1
70.2STEPV	B70PDR							15 3/8	391	6 1/8	157		50.3	22.8
70.3STEPH	B70.3PDR	2 3/4	69	7 1/8	181	9 5/8	244						52.1	23.6
70.3STEPV	B70.3PDR							15 3/8	391	6 1/8	157		53.6	24.3
80.2STEPH	B80PDR	3 3/16	81	8 11/16	221	10 11/16	272						70.6	32
80.2STEPV	B80PDR							16 13/16	427	6 3/4	172		72.2	32.7
80.3STEPH	B80.3PDR	3 3/16	81	8 11/16	221	10 11/16	272						74	33.5
80.3STEPV	B80.3PDR							16 13/16	427	6 3/4	172		75.5	34.2
Hydraulic														
46.2STHP	B46PDR							9 1/4	234	5 1/8	130		28	12.7
50.2STHP	B50PDR							9 1/4	234	5 1/8	130		29.8	13.5
60.2STHP	B60PDR							9 1/4	234	5 1/8	130		39.1	17.7
60.3STHP	B60.3PDR							9 1/4	234	5 1/8	130		42.4	19.2
70.2STHP	B70PDR							9 1/4	234	5 1/8	130		41.5	18.8
70.3STHP	B70.3PDR							9 1/4	234	5 1/8	130		44.8	20.3
80.2STHP	B80PDR							9 7/8	250	5 1/8	130		80.9	36.7
80.3STHP	B80.3PDR							9 7/8	250	5 1/8	130		84.2	38.2

*When racing, insert a racing disconnect rod to operate the winch manually. Performa disconnect rods are also available for Radial winches.

Electric Components

Battery voltage and winch size determine which components you should use. For winches size B980 and above, contact Harken for appropriate components. All components sold separately.

Each electric winch requires one control box, one circuit breaker, and two analog switches or one Digital System Switch. All new electric Radial, Performa, and captive winches are supplied with the appropriate dual-function control box. For replacement or retrofit control boxes, contact Harken.

Hydraulic winches require two analog switches or one Digital System Switch.

Analog Switches

Harken offers simple, waterproof switches for electric and hydraulic winches. Order two switches for each winch.

High-Amperage Circuit Breakers

Harken offers four panel-mount, high-amperage circuit breakers. They are compact, waterproof, weather-resistant, and ignition-protected. Circuit breakers are available for 12- or 24-volt DC systems.

Dual-Function Control Boxes

This labor-saving control box with built-in load controller combines two products into one, reducing wiring and connection points by almost half, greatly simplifying installation of Harken electric winches. Supports Digital System Switch or analog switches. A mix of switches is not supported.

System wiring may be different depending on winch size and installation. Please refer to the user manual for additional connection information.

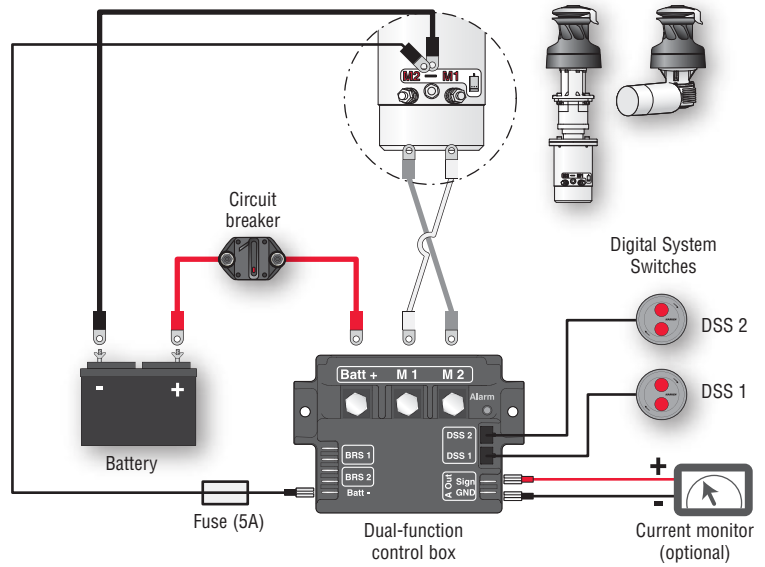

CIRCUIT BREAKERS



DUAL-FUNCTION CONTROL BOXES



ANALOG SWITCHES

Circuit Breakers

Part No.	Volts	Amp rating	Use with winch
HCP1717	12/24	80	12 volt: Radial/Performa: 40.2STE & 46.2STE, 40-46RW; Classic: B40.2STE; 24 volt: Radial/Performa: 40.2STE to 80.3STE, 40-46-60RW, 900UPW; Classic: B44.2STE to B980.2STE; CLR600; FlatWinder: FW250, FW500
HCP1718	12	100	Radial: 900UPW; Classic: B44.2STE to B60.2STE
HCP1719	12	150	Classic: B70.2STE to B980.2STE; FlatWinder: FW250, FW500; CLR1200
HCP1720	12	135	12 volt: Radial/Performa: 46.2STE12V, 50.2STE to 80.2STE, 60RW; CLR600; 24 volt: CLR1200

Analog Switches

Part No.	Description	Length		Width		Height		Weight	
		in	mm	in	mm	in	mm	oz	g
BRS102/S	Remote switch w/guard	2 11/16	68	2 11/16	68	13/16	21	10.4	295
BRS102/P	Remote switch w/guard	2 11/16	68	2 11/16	68	13/16	21	4.8	135
BRS104/P	Remote switch w/guard	3 3/8	85	3	76	3/4	19	3.4	95

Digital System Switches

Harken Digital System Switches in dual and single-function models set the standard for the reliable operation of electrically-powered yacht systems.

To accomplish this, safeguards have been built into the systems.

- The waterproof control button translates electrical information into a binary code that won't allow the system to start without the signals being verified by the decoder. An analog system sends continuous electrical information directly to the powered device which means damage to the wiring or water ingress could result in unsafe activation.
- Watertight seals are never exposed, eliminating potential damage from sun and prolonged use.
- Underneath each control button, two command switches must work in unison before a signal is sent.

Harken Digital System Switches resist impact, wear, and abrasion. A unique adhesive mounting system is available where drilling is undesirable. The product is offered in black polyamide resin or stainless steel. Integrated lighting provides low-light visibility.

Dual-function







Two-function control buttons housed in a single space-saving system—1st/2nd gear for winches, up/down for anchors, in/out for furling.

Single-function

Single control button—Pairs with the Harken UniPower single-speed winch used by cruisers.



Active buttons:
1st/2nd gear for winches, up/down for anchors, in/out for furling.

Button symbol	Part No. Ending
 	1 = 1/2
 	2 = Left/right or In/out
 	3 = Up/down
	4 = Start



DUAL-FUNCTION



SINGLE-FUNCTION

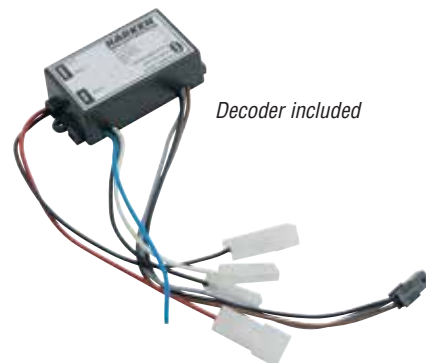

Part No.	Description	Ø		Height		Weight	
		in	mm	in	mm	oz	g
Dual-function							
DSDBK1	Dual function digital switch/1-2	3 1/8	79.6	1	25.5	4.23	120
DSDSS1	Dual function digital switch/1-2	3 3/16	80.5	1 1/32	26	4.59	130
DSDBK2	Dual function digital switch/left-right or in-out	3 1/8	79.6	1	25.5	4.23	120
DSDSS2	Dual function digital switch/left-right or in-out	3 3/16	80.5	1 1/32	26	4.59	130
DSDBK3	Dual function digital switch/up-down	3 1/8	79.6	1	25.5	4.23	120
DSDSS3	Dual function digital switch/up-down	3 3/16	80.5	1 1/32	26	4.59	130
Single-function							
DSSBK4	Single function digital switch/black	3 1/8	79.6	1	25.5	4.23	120
DSSSS4	Single function digital switch/stainless steel	3 3/16	80.5	1 1/32	26	4.59	130

CLR™ Mooring Winch



The Harken® CLR™ mooring winch is a flush-stowing, deck-mounted powered winch for both sail and power yachts featuring geometry and mechanical characteristics never before seen.

No other retracting, flush-mounted winch has offered the power-for-size ratio offered by the CLR. It stows completely belowdeck and occupies 40% less horizontal and less than 50% of the vertical space required by the previous market leaders. The CLR weighs just 33% of its competition while delivering comparable mechanical advantage.

This compact form makes it possible for yachts to mount two CLR winches at the stern quarters and one in the bow. Together, three CLR's can reduce the need for engine and thruster power while helping crews moor stern-to-dock.

The CLR employs unprecedented winch drum geometry. Five aluminum columns rotate together around a center axis. Working together, they create a very light drum that provides substantially more line-holding power and low-speed torque than would be available using a traditional drum.

The CLR offers internal LED lights at the bottom of each column for use in low-light mooring situations. Deck plates are available in aluminum, chrome, or wood grain finishes.

Harken produces two versions of the CLR: 600 kg (1322.8 lb) max pulling force for boats from 13.7 m -18.2 m (44.9' - 59.7') and 1200 kg (2645.5 lb) for boats from 18.2 m - 27.4 m (59.7' - 89.9'). It is available in 12 or 24 volt electric or hydraulic power.



LED lights are integrated at the bottom of each column for low-light mooring situations.

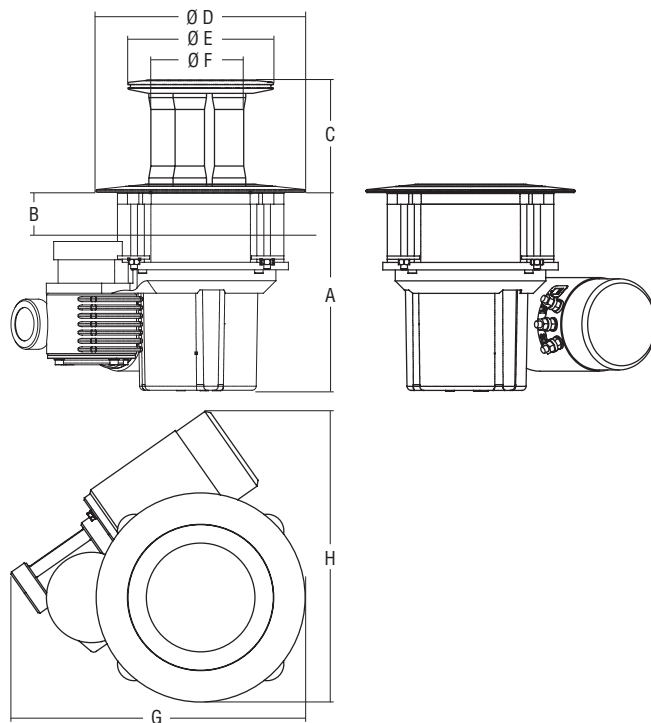

Winch size	Max line speed*		Weight				Maximum working load	
	ft/min	m/min	Aluminum**		Chrome**		lb	kg
CLR600E	82	25	39.7	18	48.5	22	1320	600
CLR1200E	75.5	23	48.5	22	57.3	26	2640	1200

*Line speed is measured with no load. **Deck plate material.

Dimensions

Winch size	A		B		C		D		E		F		G		H			
	in	mm	in	mm	in	mm	in	mm	in	mm	in	mm	in	mm	in	mm		
CLR600E	9 13/16	250	5/8	15	2 15/16	75	4 1/2	114	7 7/8	200	5 11/16	144	3 15/16	100	12 3/4	323	15 1/16	383
CLR1200E	9 5/16	237	5/8	15	2 5/32	55	5	127	9 13/16	250	6 7/8	174	4 3/4	120	13 7/8	352	13 11/16	347

Aluminum Powered Winches

Harken aluminum winches are hardcoat-anodized to resist corrosion. Anodization colors can be customized to match your yacht's aesthetics. Winches are also available with carbon fiber tops and skirts.

Harken megayacht winches are kings of power and speed that will set you on the path to fast, efficient sail handling. Contact a Harken project manager to configure optimal gear ratios, electric or hydraulic motor selection, and power settings for your application, ensuring your winches perform at full potential—from superfast line speeds needed for jibes, to hoisting a wet headsail to the top of the mast in fast gear.

B990.2STAAA
B990.3STAAA



B1000STAAA



B1145STAAA



B1145STGGG



Product not stocked. Contact Harken to request quote and lead time.

Stainless Steel Powered Winches

Harken stainless steel winches come standard with durable, lustrous classic stainless finish. For an even more stunning look, they can be polished to a mirror-finish.

As is true with all of the largest Harken winches, our stainless winches provide both power, speed and energy efficiency required for fast, reliable sail handling. Harken project managers are available to help configure optimal gear ratios, motor selection, and power settings, for any application.



B980.2ST
B980.3ST



B1120HL-ST



B1130ST
B1235ST
B1335ST

Product not stocked. Contact Harken to request quote and lead time.

Bronze Powered Winches

Bronze finish winches enhance your yacht's classic look, while providing the low-friction pulling power available from Harken's gearing systems. Marine-grade, polished-bronze maximizes durability and corrosion resistance.

All Harken megayacht winches offer a comprehensive range of power and speed that will set you up for fast, efficient sail handling. Your Harken project manager is available to work with you on gear ratios, motor selection, and power settings, ensuring your winches perform at full potential—from superfast line speeds when jibing, to the power to finish a tack in the biggest breeze.



Winch tops can be engraved with your yacht's name.

B1111.3PTBBB



B1150.3STBBB



S/Y Doña Francisca, Designer: Javier Soto Acebal, Builder: Astillero Buquebus

Product not stocked. Contact Harken to request quote and lead time.

Aluminum, Stainless Steel, All-Chrome, & Bronze Winches



Ordering Information:
Specify material by adding letter code to part number. See chart for availability.

A	GGG	ASA	CCC	CCS	SSS
Letter code		1st Letter: Base		2nd Letter: Drum	
A		Aluminum		Aluminum	
GGG		Grey-anodized aluminum		Grey-anodized aluminum	
ASA		Aluminum		Aluminum	
CCC		Chromed bronze		Chromed bronze	
CCS		Chromed bronze		Stainless steel	
SSS		Stainless steel		Stainless steel	
BBB		Polished bronze		Polished bronze	

Letter code					
A		Aluminum		Aluminum	
GGG		Grey-anodized aluminum		Grey-anodized aluminum	
ASA		Aluminum		Aluminum	
CCC		Chromed bronze		Chromed bronze	
CCS		Chromed bronze		Stainless steel	
SSS		Stainless steel		Stainless steel	
BBB		Polished bronze		Polished bronze	

B1111-HL and B1235 drums are always supplied with a stainless steel ring.

Part No.	Materials					
	A	GGG	ASA	CCC	CCS	SSS
Plain-Top						
B980.2/B980.3	—	—	—	—	—	—
B1111.3PT	—	—	—	—	—	—
Self-Tailing						
B980.2ST/B980.3ST	✓	✓	—	—	—	—
B990.2ST/B990.3ST	✓	✓	—	—	—	—
B1000.2ST/B1000.3ST	✓	✓	—	—	—	—
B1111.3ST	✓	✓	—	—	—	—
B1120.3-HL ST	✓	✓	—	—	—	—
B1130.3ST	✓	✓	—	—	—	—
B1235.3ST	✓	✓	—	—	—	—
B1335.3ST	✓	✓	—	—	—	—
B1445.3ST	✓	✓	—	—	—	—
B1150.3ST	—	—	—	—	—	—

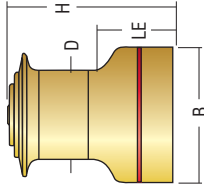
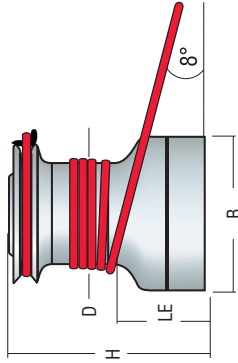
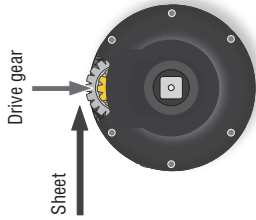

Part No.	Drum (D)	Base (B)	Height (H)	Weight		Line entry height (LE)	Fastener circle	Fasteners			Gear ratio			Power ratio						
				lb	kg			in	mm	in	mm	1	2	3	1	2	3			
Plain-Top																				
B980.2	6 7/8	1 75	10 7/16	265	11 3/4	298	94.8	43	5 13/16	148	8 7/8	225	6 x 3/8 FH	6 x 10 FH	7.3	27.8	21.2	80.7		
B980.3	6 7/8	1 75	10 7/16	265	11 3/4	298	94.8	43	5 13/16	148	8 7/8	225	6 x 3/8 FH	6 x 10 FH	2.75	7.3	27.8	8		
B1111.3PT	11	280	14 3/16	360	9 5/16	236			3 5/32	80	10 15/16	278	8 x 3/8 SH	8 x 10 SH	1	9.7	44.7	7.8		
Self-Tailing																				
B980.2ST	6 7/8	1 75	10 7/16	265	11 13/16	300	92.6	42	5 13/16	148	8 7/8	225	6 x 3/8 FH	6 x 10 FH	7.3	27.8	21.2	80.7		
B980.3ST	6 7/8	1 75	10 7/16	265	11 13/16	300	92.6	42	5 13/16	148	8 7/8	225	6 x 3/8 FH	6 x 10 FH	2.75	7.3	27.8	8		
B990.2ST*	8	203	11	280	9 1/2	241	61.7	28	3 1/4	19 3/27/32	98	9 3/16	233	7 x 5/16 FH	7 x 8 FH	9.9	40.1	24.8	100	
B990.3ST*	8	203	11	280	9 1/2	241	61.7	28	3 1/4	19 3/27/32	98	9 3/16	233	8 x 5/16 FH	8 x 8 FH	1	9.9	40.1	2.5	
B1000.2ST	6 7/8	1 75	11 5/16	287	13 3/16	335	49.6	22.5	3/8	10	6 7/16	164	9 3/16	233	8 x 3/8 SH/HH	8 x 10 SH/HH	9.4	28.1	32.1	93
B1000.3ST	6 7/8	1 75	11 5/16	287	13 3/16	335	52.3	23.7	3/8	10	6 7/16	164	9 3/16	233	8 x 3/8 SH/HH	8 x 10 SH/HH	2.23	9.4	28.1	6.5
B1111.3ST*	11	280	14 3/16	360	9 5/16	236	61.7	28	3 1/4	19 3 11/16	94	10 5/8	271	8 x 3/8 SH	8 x 10 SH	1	9.7	44.7	7.8	
B1111.3ST-HL	11	280	13 13/16	351	10 3/8	263	92.6	42	7/16	11 3/4	19 3 9/16	91	10 5/8	271	8 x 3/8 SH	8 x 10 SH	1	9.7	44.7	7.8
B1120.3-HL ST	11 3/4	298	16 15/32	418	15 11/16	398	227	103	9 1/16	14	25 6 13/32	163	12 3/4	324	9 x 12 SH	2.6	10.8	55.2	4.4	
B1125.3ST*	11 13/16	300			9 13/16	249			7/16	11 3/4	19 4 1/8	105	11 15/16	303	9 x 12 SH	4	13.5	54.7	6.8	
B1130.3ST*	12 3/4	324	16 3/32	409	12 1/8	308	94.8	43	5/8	16	25 4 17/32	115	12 3/4	324	9 x 12 SH	1	10.8	55.2	1.6	
B1235.3ST	12 3/4	324	16 3/32	409	12 1/8	308	170.6	77.4	5/8	16	25 4 11/16	119	12 3/4	324	9 x 12 SH	1	9.4	48	1.6	
B1335.3ST	12 3/4	324	16 5/16	414	13 15/32	342	233.7	106	5/8	16	25 6 1/16	153	14 9/16	370	11 x 12 SH	2.3	8	38.2	3.7	
B1445.3ST	14 1/4	362	21 3/16	538	16 1/2	419	321.9	146	5/8	16	7/8	22 8 3/16	208	14 x 12 SH	2.9	11.9	53.6	4.1		
B1150.3ST‡	16 5/32	410	25 3/16	640	19 3/4	502	449.7	204	9/16	14	25 8 7/8	225	22 1/16	560	12 x 12 SH	3.4	15.3	64.9	4.2	

Product not stocked. Contact Harken to request quote and lead time. * Reduced first gear. ‡ Weight based on top cleat.

Carbon Fiber Winches

TP52 © Max Ranchi



Carbon Fiber Winches

Carbon winches are standard in many racing classes and are the choice of performance-oriented fast cruisers.

Winches feature carbon skirts and tops, aluminum drums, and strong composite jaws with one-piece sculpted line guide and peeler. PEEK roller bearings are low-maintenance, reliable, and efficient. They ride in large-diameter cages, allowing more bearings to carry the load. Stainless steel drive gears are strong and durable. The AC versions of the 65.3ST and 65.2ST winches feature titanium gears for extremely high strength-to-weight ratios and exceptional resistance to corrosion.

Carbon winches come with up to three speeds and can be driven by handle, pedestal, or by electric or hydraulic motors. Harken's 50.3STR is the smallest three-speed direct drive self-tailing winch in the industry.

Harken designed the 600.3STR wide-body, self-tailing winch for use on Fast 40+ class boats for use as primary and mainsheet winches. The 600.3STR, which is made from aluminum, is a direct drive three-speed winch that can be driven by handle or pedestal.

Options include self-tailing arms, top cleats, free-spinning or ratcheting base sheave additions, and left-handed rotation.

If class rules dictate, winches are also available in all-aluminum with stainless steel gears.



B50.3STR



B50.2STR



B500.3TCR



B500.2STR



B600.3STR



B65.3TCR



B65.2STR



B65.3STAC



B65.2STAC

DNA F4 Catamaran, 14.2 m (46.7') © DNA Performance Sailing



Product not stocked. Contact Harken to request quote and lead time.

Carbon Fiber Winches

These powerful carbon winches are aboard large megayachts, performance cruisers, and racing monohulls and multihulls over 18 m (60').

Winches feature carbon skirts and tops, aluminum drums, and strong composite jaws with one-piece sculpted line guide and peeler. PEEK roller bearings are low-maintenance, reliable, and efficient. They ride in large-diameter cages, allowing more bearings to carry the load. Stainless steel drive gears are strong and durable. The AC versions of the 1111PT and 990.3ST winches feature titanium gears for extremely high strength-to-weight ratios and exceptional resistance to corrosion.

Drives are pedestal, electric, or hydraulic. Wide-diameter drums provide extra surface area to hold line securely under high loads. Fewer wraps speed line retrieval when sheeting.

Other options include self-tailing, top cleats, four speeds, free-spinning or ratcheting base sheave additions, and left-handed rotation.

If class rules dictate, winches are also available in all-aluminum with stainless steel gears.



B990.3TCR



B990.3STAC

5T



B1111.3PTAC

5.5T



B1111.3STR



7T

B1125.3STR



B1130.3TCR

9T



B1130.3STR



11T

B1135/B1235.3STR



13T

B1145.3TCR



13T

B1145.3STR



Product not stocked. Contact Harken to request quote and lead time.

Carbon Fiber Winches



Use base sheaves for cross-sheeting and lazy sheets. Availability varies by winch size.



Base riser required to mount B50, B55, and B65 winches above deck. Specify above deck or flush deck version when ordering.

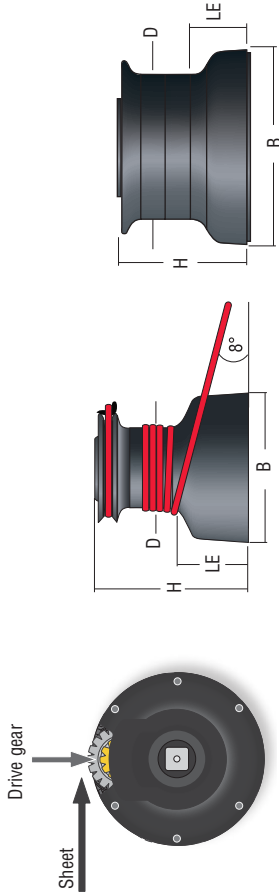

Part No.	Drum (D)		Base (B)		Height (H)		Weight		Line Ø		Line entry height (LE)		Fastener circle		Gear ratio				Power ratio									
	in	mm	in	mm	in	mm	lb	kg	Min	Max	in	mm	in	mm	in	mm	1	2	3	4	1	2	3	4				
B50.2STR†	4.9/16	116	7.1/4	184	6.5/8	168	11.7	5.3	3/16	5	3/8	10	2.9/16	65	6.15/32	164	6 x 5/16 FH	6 x 8 FH	2.7:1	11.4:1	11.7:1	50.7:1	11.7:1	50.7:1	4.4:1	11.7:1	49.8:1	
B50.3STR	4.9/16	116	7.1/4	184	6.7/8	175	13.7	6.2	3/16	5	3/8	10	2.9/16	65	6.15/32	164	6 x 5/16 FH	6 x 8 FH	1:1	2.7:1	11.4:1	11.7:1	50.7:1	4.4:1	11.7:1	49.8:1		
B500.2STR	4.9/16	116	7.1/4	184	6.5/8	168	11	5	3/16	5	3/8	10	2.9/16	65	6.15/32	164	6 x 5/16 FH	6 x 8 FH	2.7:1	11.4:1	11.7:1	50.7:1	11.7:1	50.7:1	3.9:1	10.4:1	44.5:1	
B500.3TRC	5.1/8	130	7.1/4	184	6.7/8	175	13.7	6.2	2.5/32	55	6.15/32	164	2.9/32	55	6.15/32	164	6 x 5/16 FH	6 x 8 FH	1:1	2.7:1	11.4:1	11.7:1	50.7:1	3.9:1	10.4:1	44.5:1		
B65.2STR**	5.7/8	149	10	255	7.13/16	199	20.9	9.5	5/16	8	5/8	16	3.1/4	83	8.29/32	226	6 x 5/16 FH	6 x 8 FH	4.6:1	19.2:1	15.7:1	65.5:1	15.7:1	65.5:1	15.7:1	65.5:1		
B65.3TRC	5.7/8	149	10	255	7.13/16	199	20.9	9.5	5/16	8	5/8	16	3.1/4	83	8.29/32	226	6 x 5/16 FH	6 x 8 FH	4.6:1	19.2:1	15.7:1	65.5:1	15.7:1	65.5:1	15.7:1	65.5:1		
B65.3STR**	5.7/8	149	10	255	8.29/32	226	26	11.8	5/16	8	5/8	16	3.1/4	83	8.29/32	226	6 x 5/16 FH	6 x 8 FH	1:1	4.6:1	19.2:1	15.7:1	65.5:1	3.4:1	15.7:1	65.5:1		
B65.3TRC	5.7/8	149	10	255	8.29/32	226	25.4	11.5	3/4	83	8.29/32	226	3.1/4	83	8.29/32	226	6 x 5/16 FH	6 x 8 FH	1:1	4.6:1	19.2:1	15.7:1	65.5:1	3.4:1	15.7:1	65.5:1		
B65.3STR	5.1/8	130	7.1/4	184	6.7/8	175	15.0	6.8	3/16	5	3/8	10	2.9/16	65	6.15/32	164	6 x 5/16 FH	6 x 8 FH	1:1	2.66:1	14.60:1	15.7:1	65.5:1	3.9:1	10.42:1	47.05:1		
B650.3STR	5.7/8	149	9	228	7.7/32	183	21.1	9.6	5/16	8	5/8	16	3.1/4	83	9.27/32	250	5 x 5/16 FH	5 x 8 FH	1:1	4.6:1	19.2:1	15.7:1	65.5:1	3.4:1	15.7:1	65.5:1		
B650.3TRC	5.7/8	149	9	228	7.7/32	183	20	9.1	3/4	83	9.27/32	250	3.1/4	83	9.27/32	250	5 x 5/16 FH	5 x 8 FH	1:1	4.6:1	19.2:1	15.7:1	65.5:1	3.4:1	15.7:1	65.5:1		
B990.3STR	8	203	11	280	9.1/2	241	44.8	20.3	7/16	11	3/4	19	3.27/32	98	9.3/16	233	8 x 5/16 FH	8 x 8 FH	1:1	9.9:1	40:1	25.1:1	24.8:1	100:1	2.5:1	24.8:1	100:1	
B990.3STRAC	8	203	13.1/16	332	9.7/16	240			7/16	11	3/4	19	3.27/32	98	12	305	8 x 5/16 FH	8 x 8 FH	1:1	9.9:1	40:1	25.1:1	24.8:1	100:1	2.5:1	24.8:1	100:1	
B990.3TRC	8	203	11	280	9.7/16	240	41.5	18.8	3.27/32	98	9.3/16	233	3.27/32	98	9.3/16	233	8 x 5/16 FH	8 x 8 FH	1:1	9.9:1	32:1	25.1:1	24.8:1	100:1	2.5:1	24.8:1	100:1	
B1111.3STR*	11.1/32	280	14.3/16	360	9.5/16	236	54	24.5	7/16	11	3/4	19	3.11/16	94	10.21/32	271	8 x 3/8 SH	8 x 10 SH	1:1	9.7:1	44.7:1	18.1:1	17.6:1	81:1	1.8:1	17.6:1	81:1	
B1111.3TRC*	11.1/32	280	14.3/16	360	8.5/32	207	41	18.6					3.11/16	94	10.11/16	271	8 x 3/8 SH	8 x 10 SH	1:1	9.7:1	44.7:1	18.1:1	17.6:1	81:1	1.8:1	17.6:1	81:1	
B1111.3PTAC*	11.1/32	280	14.3/16	360	8.19/32	218							3.11/16	94	10.21/32	271	8 x 3/8 SH	8 x 10 SH	1:1	3:1	9.7:1	44.7:1	18.1:1	17.6:1	81:1	1.8:1	17.6:1	81:1
B1111.3STAC	11.1/32	280	14.3/16	360	9.9/32	236			7/16	11	3/4	19	3.11/16	94	10.21/32	271	8 x 3/8 SH	8 x 10 SH	1:1	3:1	9.7:1	44.7:1	18.1:1	17.6:1	81:1	1.8:1	17.6:1	81:1
B1130.3STR	12.3/4	324	16.3/32	409	12.1/8	308	86	39	5/8	16	1	25	4.17/32	115	12.3/4	324	9 x 1/2 SH	9 x 12 SH	1:1	10.8:1	55.2:1	16.1:1	16.9:1	86.6:1	1.6:1	16.9:1	86.6:1	
B1130.3TRC	12.3/4	324	16.3/32	409	11.17/32	293	86	39					4.17/32	115	12.3/4	324	9 x 1/2 SH	9 x 12 SH	1:1	10.8:1	55.2:1	16.1:1	16.9:1	86.6:1	1.6:1	16.9:1	86.6:1	
B1135.3STR	12.3/4	324	16.3/32	409	12.1/8	308	92.6	42	5/8	16	1	25	4.17/32	115	12.3/4	324	9 x 1/2 SH	9 x 12 SH	1:1	10.8:1	55.2:1	16.1:1	16.9:1	86.6:1	1.6:1	16.9:1	86.6:1	
B1135.3TRC	12.3/4	324	16.3/32	409	11.17/32	293	77	35					4.17/32	115	12.3/4	324	9 x 1/2 SH	9 x 12 SH	1:1	10.8:1	55.2:1	16.1:1	16.9:1	86.6:1	1.6:1	16.9:1	86.6:1	
B1235.3STR	12.3/4	324	16.3/32	409	12.1/8	308	101.4	46	5/8	16	1	25	4.11/16	119	12.3/4	324	9 x 1/2 SH	9 x 12 SH	1:1	9.4:1	48:1	16.1:1	14.7:1	74.3:1	1.6:1	14.7:1	74.3:1	
B1335.3STR	12.3/4	324	16.5/16	414	13.7/16	342			5/8	16	1	25	6	153	14.9/16	370	11 x 1/2 SH	11 x 12 SH	2.9:1	8:1	38.2:1	3.7:1	12.5:1	59.9:1	3.7:1	12.5:1	59.9:1	
B1140.3STR	14.3/16	360	22.1/8	562	18.3/16	462	249.2	113	5/8	16	1	25	8.11/32	212	18.1/8	460	8 x 12 SH	8 x 12 SH	2.9:1	11.6:1	42.6:1	4.1:1	16.4:1	60.1:1	4.1:1	16.4:1	60.1:1	
B1145.3STR	14.1/4	362	21.3/16	538	16.1/2	419	192.9	87.5	5/8	16	7/8	22	8.3/16	208	17.3/4	450	14 x 1/2 SH	14 x 12 SH	2.9:1	11.9:1	53.6:1	4.1:1	16.6:1	75.6:1	4.1:1	16.6:1	75.6:1	
B1145.3TRC	14.1/4	362	21.3/16	538	16.1/2	419	187.1	84.9	3/4	19	1.1/4	32	8.3/16	208	17.3/4	450	14 x 1/2 SH	14 x 12 SH	2.9:1	11.9:1	53.6:1	4.1:1	16.6:1	75.6:1	4.1:1	16.6:1	75.6:1	

Product not stocked. Contact Harken to request quote and lead time. *4 Speed option available. Contact Harken. **Available in electric. †Available in electric or hydraulic.

Air Winches

Harken Air winches feature a set of interchangeable gearing kits that give skippers the flexibility to create a perfect blend of speed and power for each day's weather and crew configuration. The winches, which feature a nearly empty middle to reduce weight, were designed for trimming sails on AC foiling cats, IMOCA 60s, AC75s, TP52s and similar Grand Prix boats.

The hollow middle is a first for sailing winches, as are the changeable gear kits. All Harken Air winch models feature interchangeable first-speed and second-speed options. The wide-diameter drums allow fewer wraps, faster trimming, and faster easing. Standard and counter-rotating versions are available. The winches have a low-profile design. Available in four models: 250, 300, 550, and 600.

The 250 and 300 models are designed for boats up to 17 m (56'). The 550 and 600 models are designed for boats up to 24.4 m (80'). The 250 and 550 feature a high-performance ceramic coated white drum. The 300 and 600 versions of the winch feature an anodized aluminum drum.

The 250 and 550 are designed for new builds and are mounted in a unique way: the base of the winch is molded into the deck by the boatbuilder. The 300 and 600 have a standard winch base that can be mounted on either new builds or retrofits.

All models can be driven by pedestal or handle. The 300 can be powered by electric or hydraulic motor.



 Air winch 250 aboard a TP52



Air winch 250
Air winch 550



Air winch 300
Air winch 600

Product not stocked. Contact Harken to request quote and lead time.



TP52 © Max Ranchi

Part No.	Gear ratio			Power ratio		
	1	2	3	1	2	3
Air winch 250	1.34:1	6.40:1	25.42:1	3.42:1	16.27:1	64.57:1
Air winch 300	1.34:1	6.40:1	25.42:1	3.42:1	16.27:1	64.57:1
Air winch 550	1.30:1	10.58:1	47.98:1	2.21:1	17.92:1	81.25:1
Air winch 600	1.30:1	10.58:1	47.98:1	2.21:1	17.92:1	81.25:1

Part No.	Drum		Base		Height		Weight		Line Ø		Line entry height		Fastener circle		Fasteners
	in	mm	in	mm	in	mm	lb	kg	Min	Max	in	mm	in	mm	
Air winch 250	7 7/8	200	10 21/32	271	5 3/4	146	16.1	7.3	3/16	5	3/8	10	1 15/16	50	
Air winch 300	7 7/8	200	10 21/32	271	6	153	17.0	7.7	3/16	5	3/8	10	2 1/4	57	8 9/32 210 5 x M8
Air winch 550	11 13/16	300	14 15/16	380	6 7/8	174	27.3	12.4	1/4	6	1/2	12	2 7/16	61	
Air winch 600	11 13/16	300	14 15/16	380	7 3/16	182	32.6	14.8	1/4	6	1/2	12	2 3/4	69	12 13/16 325 7 x M10

Racing Pedestals

Racing pedestals allow crew members to trim from powerful standing positions. Customized to meet each yacht's requirements, these pedestal systems can be linked together, allowing crew to work in tandem to produce more power for faster, more efficient maneuvers.

Belt-Drive Pedestals

Harken belt-drive pedestals are molded from carbon fiber and epoxy. Prepreg lamination and autoclave curing maximize stiffness and strength. Components are made of hardcoat-anodized aluminum and 17-4 PH stainless steel. Roller bearings, thermoplastic belt sprockets, and carbon-fiber reinforced drive belts result in the lowest possible weight.

Belowdeck belt-drive pedestals are also offered in above deck/mid-drive styles. These pedestals can be removed and winches converted to manual operation to make more room in the cockpit during a long-distance race or cruise.

MX Pedestals

Harken MX carbon pedestals drive winches on small Grand Prix racers like GP42s, GP52s and Open 60s. The patented overdrive system features two chains inside the pedestal, eliminating the weight of an external overdrive box. Two drive sprockets allow trimmers to select the gear ratio, switching between the 1:1 direct-drive and the fast 1:3 drive chain without reversing grinding directions.



Pedestal handles

Pedestal handles are offered in aluminum or carbon fiber and in single, double, or SpeedGrip styles.

A SpeedGrip pedestal handle is a great solution for solo sailors because it frees up a hand for another task. SpeedGrip winch handles can be special-ordered from Harken.

MX PEDESTAL

MX pedestal

The red shaft of the left button indicates the 1:3 overdrive is engaged. Every turn of the handle produces three turns of the winch.

MX drive sprockets



1:3 chain engaged

1:1 chain engaged

BELT-DRIVE PEDESTALS



Twisted

Twisted belt-drive pedestals eliminate the weight of the 90° gear box when the grinder faces fore and aft.

Straight

A disconnect lever for an above-deck/mid-drive belt pedestal system is available.

Angled

An angled pedestal is customized to optimize the deck layout or tailored to the grinder for maximum comfort.

Air pedestal

The athwartship-mounted Air pedestal has a sculpted hole in the middle, with each leg shaped like a wing—the ultimate in drag reduction.

Wing pedestal

The Wing pedestal mounts fore and aft. It's extremely narrow aerodynamic shape dramatically reduces drag.

Product not stocked. Contact Harken to request quote and lead time.

Racing Pedestal Drive Components

Gear Boxes

The bevel gearbox is the basic building block of belt-drive pedestal systems. The B606 gear box is designed for up to a six-man, three-pedestal input.

Gearbox housings are CNC-machined from a solid piece of aluminum, hardcoat-anodized for strength and durability. Gears, shafts, and rollers are 17-4 PH stainless steel and are lubricated in a sealed oil bath for minimal maintenance.

Drive Shafts

Harken offers two types of drive shafts. Extruded, splined, aluminum drive shafts may be cut to length. Carbon tubular drive shafts are available with bonded end fittings for U-Joints or spherical CV-Joints. Shaft choice is determined by load, cost, and weight considerations. Your Harken representative can provide details on the best drive shaft for your boat.

Disconnects

System disconnects can be activated with either levers and control lines for hand operation, or a two-position push button for foot activation. The Harken foot button has fewer than 10 components, compared to almost 100 in other buttons, minimizing the possibility of losing or breaking parts. Foot button tops come in red, black, or blue to distinguish functions above deck.

Support Shafts

To space and support a gearbox beneath a winch, Harken supplies tubes for the B404, B606, and B808 series gearboxes. Tubes are made to length from carbon fiber/epoxy with bonded aluminum ends.



B606



Foot button disconnect



Universal Joint



Drive shafts

404 gear box



808 gear box

The 404 gearbox is designed for the TP52 Class. It allows for the power of as many as four crew members using two pedestals to be applied to a single winch drum. The 404 is a small, light and highly efficient bevel box. The 808 gearbox is designed for boats with four or more pedestals on board. It allows for the power of as many as eight crew members. Both the 404 and 808 gearboxes are oil-bath lubricated and have inspection windows.



Carbon wheel

Cantilevered gearbox bracket



Y-box & carbon fiber spinnaker retrieval system

Pedestal-driven, belowdeck carbon wheel ensures high-speed spinnaker retrieval. Optional carbon T-box brackets and cantilevered gearbox brackets hold gearbox in position belowdeck; customized to boat.

T-box bracket



Product not stocked. Contact Harken to request quote and lead time.

Accessories: Carbo OneTouch® Locking Winch Handle

Lightweight and fast-acting, the Carbo OneTouch ball bearing locking winch handle makes grinding winches easy! Racers will maneuver faster and cruisers will have confidence in a reliable and easy-to-use winch handle.

The Carbo OneTouch locks in and out of the winch using its patented locking mechanism and ergonomically-designed grab bar. It only takes one hand to set or release the handle—squeeze anywhere along the grab bar with your palm to unlock; release the bar for a secure lock.

Harken added SpeedGrip handle technology to the OneTouch for fast and efficient winching. Its independent swivel between the ball bearing knob and hand-grip allows fast trimming using the palm for low-loads, and powerful two-handed grinding when loads are high.

At just 590 g (20.8 oz), the Harken Carbo OneTouch is built to be strong but lightweight. The grab bar and main handle are made of the same tough material as our Carbo block line: high-strength, fiber-reinforced composite, UV-stabilized for excellent protection against long-term exposure to saltwater and sun. The handle and grab bar are cross-ribbed and braced for enhanced stiffness.

An aluminum grip rod mates seamlessly to a forged aluminum handle insert to manage bending stresses. The black hardcoat-anodized octagonal drive gear is also integrated into the molding process, resulting in an extremely strong, one-piece structure. Its locking pins are tough 316 marine-grade stainless steel.



OneTouch is a registered trademark of Donald J. Steiner.



Molded urethane knob for comfortable feel and better grip when palming the handle.

Handle features an independent swivel between the knob and handle to keep the wrist straight and arms in the best power position while grinding.



The patented locking mechanism features two stainless steel pins that automatically retract when the handle's full-length grab bar is squeezed, and extend when it is released for a solid, secure lock.



Ofcet 32, 9.75 m (32'), naval architect:
Marc Lombard © Chantier Ofcet

Part No.	Description	Length (A)		Height (B)		Rise (C)		Weight	
		in	mm	in	mm	in	mm	oz	g
SpeedGrip									
B10HOT	Lock-in/Carbo OneTouch	9 1/2	241	7 1/8	181	1 5/16	33	20.8	590

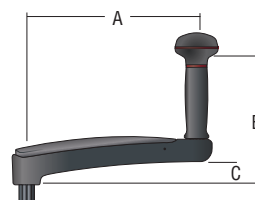

Accessories: Aluminum, Chrome and Bronze Handles



Winch handle lock repair



These robust low-friction ball bearing handles match a range of cranking needs for both racers and cruisers. Handles feature a ball bearing grip that efficiently transmits power into the winch. All handles fit international standard winch sockets.

Locking vs. Plain

Lock-in handles are easy to engage and release with a thumb switch. Racers prefer plain handles because they are faster to insert.

Handle Length

254 mm (10") is the most comfortable handle length for most sailors. Published power ratios are based on this length.

203 mm (8") handles grind faster because they swing through a smaller circle, but power is reduced by 20%. 203 mm (8") handles are ideal for smaller boats and light air where speed is more important than power.

SpeedGrip

SpeedGrip handles are designed for the serious racer and are effective in both light and heavy air conditions. The unique grip permits low-load fast cranking using the palm, and powerful two-handed grinding when loads are high. The low-profile B8ASGLP is made for fast one-handed cranking where speed is the concern, not power.



Molded urethane knob for comfortable feel and better grip when palming the handle.

Handles feature an independent swivel between the knob and handle to keep the wrist straight and arms in the best power position while grinding.

The 254 mm (10") B10ADL handle features a lock-in switch and provides powerful two-handed grinding.



SPEEDGRIP

STANDARD

Part No.	Description	Length (A)		Height (B)		Rise (C)		Weight	
		in	mm	in	mm	in	mm	oz	g
SpeedGrip									
B8ASGLP	Lock-in/low-profile/aluminum	8	203	4 13/16	122	1 1/4	32	14.1	400
B8ASG	Lock-in/aluminum	8	203	7 3/16	182	1 1/4	32	17.6	500
B8CSG	Lock-in/chrome	8	203	7 3/16	182	1 1/4	32	35.3	1000
B10ASG	Lock-in/aluminum	10	254	7 7/16	188	1 1/2	38	21.2	600
B10CSG	Lock-in/chrome	10	254	7 7/16	188	1 1/2	38	47.6	1350
Standard									
B8AP	No-lock/aluminum	8	203	6 5/8	168	1 1/4	32	14.1	400
B8AL	Lock-in/aluminum	8	203	6 5/8	168	1 1/4	32	14.1	400
B8BL	Lock-in/bronze	8	203	6 5/8	168	1 1/4	32	31.7	900
B8CL	Lock-in/chrome	8	203	6 5/8	168	1 1/4	32	31.7	900
B10AP	No-lock/aluminum	10	254	7	178	1 1/2	38	17.6	500
B10AL	Lock-in/aluminum	10	254	7	178	1 1/2	38	17.6	500
B10BL	Lock-in/bronze	10	254	7	178	1 1/2	38	45.9	1300
B10CL	Lock-in/chrome	10	254	7	178	1 1/2	38	45.9	1300
B10ADL	Lock-in/double-grip/aluminum	10	254	11 1/4	286	1 13/16	46	21.2	600

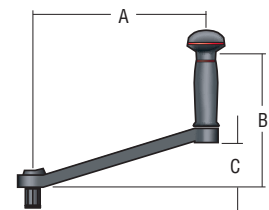

Accessories: Service Kits

You should service your winches at least once during the preseason. However, twice a season is best if your boat lives in salt water. If you race your boat hard, you may want to maintain your winches before every regatta. Keep your winches clean and operating smoothly by flushing frequently with fresh water. Check pawls and springs, bearings, gears, and spindles for signs of wear and corrosion.

For more details, consult the maintenance manual.

Installation manuals and parts lists are available online at www.harken.com.



BK4514

BK4521

BK4513



BK4512



BK4515
BK4516



BK4517



BK4518



BK4519



Radial winch



Classic winch

WINCH Q&A

WHICH PARTS DO I GREASE AND WHICH DO I OIL ON MY HARKEN WINCHES?

Grease all metal gears and roller bearings with Harken Winch Grease. It's highly resistant to salt and fresh water, works in all temperatures, and protects against corrosion. NEVER grease pawls or springs because grease causes them to stick. Instead, lubricate with Harken Pawl Oil for optimal rotation. Radial winches and carbon winches have composite roller bearings that do not need to be lubricated.

Part No.	Description	Includes	Fits winches			
			Radial	Performa	Classic	Custom/Racing*
BK4512	Winch service kit	10 pawls, 20 springs	2-speed: 15 - 70.2, Rewind, UniPower	20	B6 - B980	1000.3
BK4513	Winch grease	100 ml tube				
BK4514	Winch service case	10 pawls, 20 springs, pawl oil, winch grease, handle repair kit, stickers	2-speed: 15 - 70.2, Rewind, UniPower	20	B6 - B980	1000.3
BK4515	Racing winch service kit/10 mm	10 17-4 PH pawls, 20 springs	80			880 - 1150
BK4516	Racing winch service kit/8 mm	10 17-4 PH pawls, 20 springs	60.3, 70.3	35 - 70, Quattro		50 - 650, Air® winches
BK4517	Lock-in handle repair kit	Lock-in knob, spring pin, lock-in spring, isolator, lock-in plate		All handles		
BK4518	Winch drum screw kit	8 screws 8 mm x 20 mm, 8 plastic washers			B48 - B980	
BK4519	Winch drum screw kit	8 screws 8 mm x 20 mm, 8 plastic washers			B16 - B46	
BK4521	Pawl oil for pawls and springs					

*Custom and racing winch service kits might not include all the pawls needed. Please contact Harken.

Captive Reel Winches

Electric & Hydraulic

Harken captive reel winches represent a leap forward in captive winch design. The result of years of intense development at Harken Italy's dedicated facility, captive winches are offered in more sizes than ever, with pulling loads of 1.5 to 70 tons, and for boats from 45 feet and up. All sizes are offered with electric or hydraulic motors. Harken's latest captive winches don't just offer an impressive line speed when hauling in—they can ease a line just as quickly and safely when rapid response is needed. Robust and compact, these belowdeck winches keep topsides clear for a clean, uncluttered look. Use for remote line handling: raise/lower halyard, trim/ease mainsheet—all at the touch of a button or a nudge of a joystick for even more fine-tune line speed or trimming control.

Jeanneau 64, 20.1 m (65'11") Philippe Briand design © David Clapp Photography Ltd / Jeanneau



Captive Reel Winches: 1.5 - 3T

Once the domain of only the largest yachts, a new wave of captive winch design and technology has provided the catalyst for the development of winches for boats in the 14 m -18 m (45' - 60') range. Robust and compact, these belowdeck winches keep topsides clear for a clean, uncluttered look. Use for remote line handling: raise/lower halyard, trim/ease mainsheet—all at the touch of a button.

The winch frame and drum are 6061-T6 hardcoat-anodized aluminum. All parts connected to hydraulic or electrical circuitry are positioned on the same side for maintenance. The screw bearings and gear transmission are also located on this side for easy inspection. Bearings are self-lubricated. The main gearbox is sealed and lubricated with oil.

Electric Versions

Electric captives in 1.5-ton and 3-ton sizes come standard with 12-volt or 24-volt power. The 3T version is also available with a 24-volt high-speed (HS) motor. The winch has a single gear and is managed with push buttons for trimming and easing. A mechanical switch limits the stroke of the feeder to prevent overrides. Winches include a dual-function control box with a built-in load controller that combines two products into one, reducing wiring and connection points by almost half and greatly simplifying installation. The dual-function control box supports the Digital System Switch or analog switches. A mix of switches is not supported.

Hydraulic Versions

Hydraulic 1.5-ton and 3-ton captive winches are driven by industrial-sealed, fixed-displacement motors. The synchronized transmission uses two gear sets (four gears) to drive the twin feeder screws. To change line diameter, the gear sets must be replaced. The feeder transmission's twin feeder screws balance the load on the feeder, allowing line to lie smoothly on the drum—even when slack.



The screw design positions the screw close to the drum, reducing winch size.

Electric Part Numbers

1.5T42012RHEL12

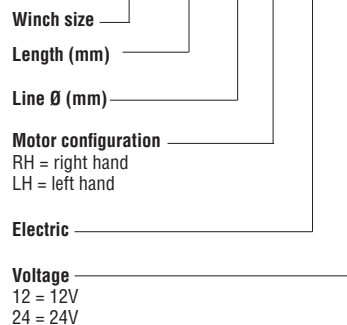

Harken 1.5T and 3T captive winches are offered with an optional built-in 90-degree line feeder for installation where space is limited.

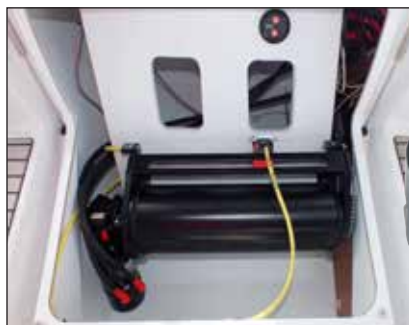

ELECTRIC



HYDRAULIC

Power/Sheet Size Guide

Part No.	Maximum dynamic pull		Maximum holding load		Min	Line Ø		Max
	lb	kg	lb	kg		in	mm	
1.5T	3300	1500	5500	2500	1/2	12	3/4	18
3T	6600	3000	11000	5000	1/2	12	3/4	18

Loads and converted sizes are guides only. Winches are customized to application. Hydraulic captive reel winches can be driven by different displacement motors. Contact Harken for max pressure details. For line storage lengths see page 227.

Electric Motors

Part No.	Max line speed		Max current amps	Control box	Circuit breaker
	ft/min	m/min			
1.5T 12V	39.4	12.0	340	Dual-Function Control Box	HCP1718
1.5T 24V	42.7	13.0	150	Dual-Function Control Box	HCP1717
3T 24V	42.7	13.0	250	Dual-Function Control Box	—
3T 24V HS	164.1	50.0	230	Motor driver	HCP1720

Hydraulic Motors

Part No.	Max pressure		Flow rate		Max line speed	
	PSI	Bar	gal/min	L/min	ft/min	m/min
1.5T	1739	120	13	50	115.9	35.0
3T	2753	190	13	50	99.3	30.0

Product not stocked. Contact Harken to request quote and lead time.

Captive Reel Winches: 6 - 70T

Captive winches are offered with pulling loads up to 70 tons with both hydraulic and electric drives for boats from 18 m (60') to the largest megayachts. Drum lengths vary to fit individual project requirements. Captives and tensioners are tested at full load before shipping.

The winch frame and drum are 6061-T6 hardcoat-anodized aluminum with a carbon-fiber gear cover to reduce weight. All parts connected to hydraulic or electrical circuitry are positioned on the same side for maintenance. The screw bearings and gear transmission are also located on this side for easy inspection. Bearings are sealed and lubricated with grease. The main gearbox is sealed and lubricated with oil.

Electric Versions

6T winches and larger run off 500-800V DC systems or 400V AC 3-phase supply. Electric motors on winches 9T and higher are customized for the application. The winch has a single gear and is managed with a joystick for trimming and easing. A gear-and-chain transmission drives the feeder screw, allowing the line to lie smoothly on the drum in a single layer. Tapping into the larger battery banks on modern yachts allows the use of electric captives in sizes previously only available in hydraulic. This provides a quieter, more efficient system. Harken has also developed an innovative push/pull captive that allows a single winch and motor to take the place of two.

Hydraulic Versions

Hydraulic winches 6T and up are offered with variable-speed motors. Custom solutions are available for higher loads. The synchronized transmission uses two gear sets (four gears) to drive the twin feeder screws. To change line diameter, the gear sets must be replaced. The feeder transmission's twin feeder screws balance the load on the feeder, allowing line to lie smoothly on the drum—even when slack. The double screw design positions the screws close to the drum, reducing winch size over similarly configured winches. The tensioner system keeps a constant load on the line to prevent overrides.



ELECTRIC



HYDRAULIC



Hydraulic versions have an open-ended design to reduce weight.



Designed for easy maintenance.



Self-lubricating feeder screw and sheave allow line to lie smoothly on the drum, even when slack.



Two inner magnetic switches factory-set at the feeder's stroke limits prevent overtravel. Two outer fail-safe limit switches automatically engage the brake.



Captive Reel Winches: 6 - 70T



My Song, Baltic 130, 39.60 m (130'), naval architect: Reichel Pugh Yacht Design, Nauta Design © Baltic Yachts

Power/Sheet Size Guide

Part No.	Maximum dynamic pull		Maximum holding load		Min	Line Ø		Max
	lb	kg	lb	kg		in	mm	
6T	13200	6000	19800	9000	9/16	14	7/8	22
9T	19800	9000	26400	12000	5/8	16	1	26
12T	26400	12000	33000	15000	3/4	18	1 1/8	28
16T	35200	16000	41800	19000	1	24	1 1/4	32
18T	39700	18000	46307	21000	1	24	1 1/4	32
25T	55100	25000	66100	30000	1 1/4	32	1 1/2	40
35T	77175	35000	99225	45000	1 3/8	34	1 15/16	50
50T	110250	50000	132300	60000	1 9/16	40	2 9/16	66
70T	154350	70000	176400	80000	1 7/8	48	2 9/16	66

Product not stocked. Contact Harken to request quote and lead time. Loads and converted sizes are guides only. Winches are customized to application. Hydraulic captive reel winches can be driven by different displacement motors. Contact Harken for max pressure details. For line storage lengths see page 227.

Electric Motors

Part No.	Max line speed		Max current amps	Control box
	ft/min	m/min		
6T 24V HS	164.1	50.0	395	Motor driver
6T 48V HS	196.9	60.0	210	Motor driver
9T				
12T				
16T				
18T				
25T				
35T				
50T				
70T				

For sizes 9T and larger, electric motors are customized to the application. Contact Harken with project requirements for options.

Hydraulic Motors

Part No.	Max pressure		Flow rate		Max line speed	
	PSI	Bar	gal/min	L/min	ft/min	m/min
6T	3478	240	18	70	344.5	105.0
9T	3623	250	21	80	259.2	79.0
12T	3623	250	26	100	285.4	87.0
16T	3623	250	32	120	255.9	78.0
18T	4133	285	32	120	255.9	78.0
25T	4061	280	32	120	239.5	73.0
35T	4061	280	32	120	262.5	80.0
50T	4714	325	42	160	295.3	90.0
70T	5076	350	53	200	262.5	80.0

Line speeds can vary with each winch and power configuration.

Captive Reel Winches

Active Line Storage

Captive Length Size	Line Ø 12 mm		Line Ø 14 mm		Line Ø 16 mm		Line Ø 18 mm	
	mm	ft m	ft m	m	ft m	m	ft m	m

1.5T								
420	49.3	14.9	43.9	13.4	39.1	11.8	33.8	10.2
520	66.5	20.1	59.4	18.1	53.0	16.0	45.7	13.8

3T								
420	49.3	14.9	41.4	12.5	39.1	11.8	33.8	10.2
520	66.5	20.1	55.9	16.9	53.0	16.0	45.7	13.8
720	101.3	30.6	85.1	25.7	80.1	24.2	69.5	21.0
920	134.5	41.0	113.0	34.5	106.6	32.5	92.2	28.1
1120	169.0	51.5	142.0	43.3	133.9	40.8	115.8	35.3

Captive Length Size	Line Ø 14 mm		Line Ø 16 mm		Line Ø 18 mm		Line Ø 20 mm		Line Ø 22 mm	
	mm	ft m	ft m	m	ft m	m	ft m	m	ft m	m

6T										
810	70.2	21.2	61.6	18.6	56.6	17.1	49.3	14.9	46.0	13.9
1010	110.9	33.5	97.3	29.4	89.4	27.0	78.1	23.6	72.8	22.0
1210	151.6	45.8	133.1	40.2	122.1	36.9	106.9	32.3	99.6	30.1
1410	192.3	58.1	168.8	51.0	154.9	46.8	135.7	41.0	126.4	38.2

Captive Length Size	Line Ø 16 mm		Line Ø 18 mm		Line Ø 20 mm		Line Ø 22 mm		Line Ø 24 mm		Line Ø 26 mm	
	mm	ft m	ft m	m	ft m	m	ft m	m	ft m	m	ft m	m

9T												
930	108.2	32.7	96.7	29.2	88.0	26.6	79.1	23.9	76.5	23.1	70.5	21.3
1130	155.6	47.0	139.0	42.0	127.1	38.4	114.5	34.6	110.6	33.4	101.6	30.7
1330	204.2	61.7	182.4	55.1	166.2	50.2	149.6	45.2	144.6	43.7	133.1	40.2
1530	252.2	76.2	225.4	68.1	205.2	62.0	185.0	55.9	178.7	54.0	164.5	49.7
1730	300.2	90.7	268.1	81.0	244.3	73.8	220.1	66.5	212.8	64.3	195.6	59.1

Captive Length Size	Line Ø 18 mm		Line Ø 20 mm		Line Ø 22 mm		Line Ø 24 mm		Line Ø 26 mm		Line Ø 28 mm	
	mm	ft m	ft m	m	ft m	m	ft m	m	ft m	m	ft m	m

12T												
1130	127.2	38.8	116.0	35.3	104.3	31.8	101.0	30.7	93.2	28.4	89.2	27.2
1330	168.3	51.3	153.2	46.7	138.1	42.1	134.0	40.7	123.4	37.6	118.1	36.0
1530	210.0	63.9	191.0	58.2	172.0	52.4	166.3	50.7	154.0	46.8	147.0	44.8
1730	251.0	76.5	229.0	69.7	206.0	62.8	199.0	60.6	184.0	56.0	176.0	53.6

Captive Length Size	Line Ø 24 mm		Line Ø 26 mm		Line Ø 28 mm		Line Ø 30 mm		Line Ø 32 mm	
	mm	ft m	ft m	m	ft m	m	ft m	m	ft m	m

16T										
1030	92.7	28.0	83.1	25.1	80.4	24.3	74.1	22.4	71.2	21.5
1330	150.9	45.6	135.4	40.9	130.7	39.5	120.5	36.4	115.9	35.0
1530	189.7	57.3	169.8	51.3	164.2	49.6	151.6	45.8	145.6	44.0
1730	228.1	68.9	204.6	61.8	197.6	59.7	182.4	55.1	175.4	53.0

Captive Length Size	Line Ø 24 mm		Line Ø 26 mm		Line Ø 28 mm		Line Ø 30 mm		Line Ø 32 mm	
	mm	ft m	ft m	m	ft m	m	ft m	m	ft m	m

18T										
1030	92.7	28.0	83.1	25.1	80.4	24.3	74.1	22.4	71.2	21.5
1330	150.9	45.6	135.4	40.9	130.7	39.5	120.5	36.4	115.9	35.0
1530	189.7	57.3	169.8	51.3	164.2	49.6	151.6	45.8	145.6	44.0
1730	228.1	68.9	204.6	61.8	197.6	59.7	182.4	55.1	175.4	53.0

Captive Length Size	Line Ø 32 mm		Line Ø 34 mm		Line Ø 36 mm		Line Ø 38 mm		Line Ø 40 mm	
	mm	ft m	ft m	m	ft m	m	ft m	m	ft m	m

25T										
1030	68.0	20.7	62.0	18.9	56.1	17.0	54.0	16.4	50.1	15.2
1330	114.0	34.7	104.0	31.6	94.0	28.5	90.2	27.5	83.3	25.4
1530	145.0	44.1	132.0	40.1	118.4	36.1	114.1	34.8	106.0	32.2
1730	175.1	53.4	159.4	48.6	143.3	43.7	138.4	42.2	128.0	39.0
1930	206.0	62.7	187.3	57.1	169.0	51.4	163.0	49.6	150.3	45.8

Captive Length Size	Line Ø 34 mm		Line Ø 36 mm		Line Ø 38 mm		Line Ø 40 mm		Line Ø 42 mm	
	mm	ft m	ft m	m	ft m	m	ft m	m	ft m	m

35T										
1330	81.4	28.41	87.4	26.64	81.6	24.86	76.0	23.18	70.5	21.48
1530	121.3	36.96	113.7	34.65	106.1	32.34	98.9	30.15	91.7	27.94
1730	149.3	45.50	140.0	42.66	130.6	39.81	121.8	37.12	112.9	34.40
1930	177.3	54.05	166.2	50.67	155.2	47.29	144.7	44.09	134.1	40.86
2130	201.1	61.31	188.6	57.48	176.0	53.65	164.1	50.02	153.7	46.36
2330	233.4	71.14	218.8	66.69	204.2	62.25	190.4	58.03	176.5	53.79

Captive Length Size	Line Ø 40 mm		Line Ø 42 mm		Line Ø 46 mm		Line Ø 50 mm		Line Ø 54 mm	
	mm	ft m	ft m	m	ft m	m	ft m	m	ft m	m

50T										
1670	128.0	39.0	119.8	36.5	111.9	34.1	104.3	31.8	96.5	29.4
1870	162.1	49.4	151.9	46.3	142.1	43.3	132.2	40.3	122.4	37.3
2070	196.5	59.9	183.7	56.0	172.2	52.5	160.4	48.9	148.3	45.2
2270	231.0	70.4	215.9	65.8	202.1	61.6	188.3	57.4	174.2	53.1
2470	265.1	80.8	248.0	75.6	232.3	70.8	216.2	65.9	200.1	61.0
2670	299.5	91.3	280.2	85.4	262.5	80.0	244.4	74.5	226.0	68.9
2870	334.0	101.8	312.3	95.2	292.7	89.2	272.3	83.0	252.0	76.8
3070	368.1	112.2	344.5	105.0	322.5	98.3	300.5	91.6	277.9	84.7

Captive Length Size	Line Ø 48 mm		Line Ø 52 mm		Line Ø 56 mm		Line Ø 60 mm		Line Ø 64 mm	
	mm	ft m	ft m	m	ft m	m	ft m	m	ft m	m

70T										
1670	117.5	35.8	109.9	33.5	102.7	31.3	95.5	29.1	88.3	26.9
1870	150.9	46.0	141.1	43.0	131.9	40.2	122.7	37.4	113.5	34.6
2070	184.4	56.2	172.6	52.6	161.4	49.2	150.3	45.8	138.8	42.3
2270	217.9	66.4	203.7	62.1	190.6	58.1	177.5	54.1	164.0	50.0
2470	251.3	76.6	235.2	71.7	220.1	67.1	204.7	62.4	189.3	57.7
2670	285.1	86.9	266.7	81.3	249.3	76.0	232.0	70.7	214.6	65.4
2870	318.6	97.1	297.9	90.8	278.5	84.9	259.2	79.0	239.5	73.0
3070	352.0	107.3	329.4	100.4	308.1	93.9	286.4	87.3	264.8	80.7

Line storage lengths are guides only. Winches are customized to application. Product not stocked. Contact Harken to request quote and lead time.

Line Tensioners

Harken lightweight line tensioners are available with either electric or hydraulic power. They provide pull to prevent line slack and overrides. Both in-line and through-deck tensioners have powered belts encasing both sides of the line, doubling pull and grip capabilities compared to other versions on the market. Tensioner manifolds are independently plumbed and include a solenoid directional cartridge to optimize tensioner functions. The pay-out circuit includes a pressure-release valve to adjust tensioner pull force. The pay-in circuit includes a relief valve to control drag and to help prevent overrides.



Line tensioner removes line slack when loading and unloading the spool.

Tensioners can be installed above deck, belowdeck, or through-deck.



Flush-deck mounting



Belowdeck mounting



CT1: 90-DEGREE LINE TENSIONER

Use with winches from 3T to 9T.
Sealed roller bearing sheave.
Mounts above or belowdeck.
Symmetrical for right hand/left hand mounting.
Handle 80-degree to 120-degree line wraps.



CT2: IN-LINE TENSIONER

Use with winches from 3T to 25T.
Two independently-powered rubber belts drive line off winch drum.
Carbon-fiber cover keeps tensioner clean and safe.

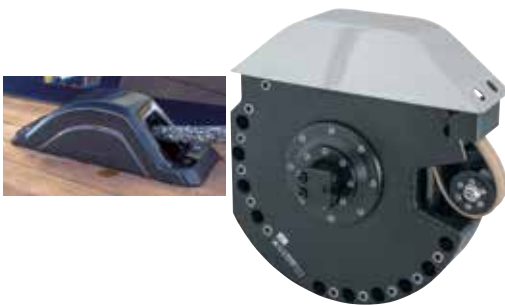

CT3: 90-DEGREE THROUGH-DECK TENSIONER

Use with winches from 3T to 25T.
300 mm sandblasted sheave handles line load.
Synchronized rubber belt adds additional grip.
Stainless steel, anodized aluminum, or carbon cover.
Waterproof sealed roller bearings.



CT5: 45-DEGREE THROUGH-DECK TENSIONER

Use with winches from 3T to 25T.
45° line deviation minimizes line stress at high loads.
Stainless steel, anodized aluminum, or carbon cover.
Waterproof sealed roller bearings.

CT4: 180-DEGREE THROUGH-DECK TENSIONER

Use with winches from 3T to 18T.
300 mm sandblasted sheave handles line load.
Synchronized rubber belt adds additional grip.
Stainless steel, anodized aluminum, or carbon cover.
Waterproof sealed roller bearings.



CT6: 90-DEGREE THROUGH-DECK TENSIONER

Use with winches from 25T to 35T.
300 mm sandblasted sheave handles line load.
Synchronized rubber belt adds additional grip.
Stainless steel, anodized aluminum, or carbon cover.
Waterproof sealed roller bearings.

CT7: 90-DEGREE THROUGH-DECK TENSIONER

Use with winches from 50T to 70T.
300 mm sandblasted sheave handles line load.
Synchronized rubber belt adds additional grip.
Stainless steel, anodized aluminum, or carbon cover.
Waterproof sealed roller bearings.

Product not stocked. Contact Harken to request quote and lead time.

HYDRAULICS



Integral Hydraulic Backstay Adjusters

Harken's integral hydraulic backstay adjuster provides the power to optimize sail shape quickly. The cylinder features a built-in, double-acting pump that delivers oil when the handle is both pushed and pulled. This moves oil through the system twice as fast as single-acting pumps on other integrals.

Assemblies include a hardcoat-anodized aluminum cylinder and pump, valve, and stainless pump handle with three attachment options: pin installs handle permanently; O-ring secures handle in socket, but is not permanent; nonlocking handle installs without O-ring and roll pin. All pins and plugs are stainless steel. Cylinders include a clevis on both ends. Standard eye-jaw toggles fit all Harken cylinders.

The pressure-release knob turns clockwise to close and pump, counterclockwise to release. When closing the pump, the knob cannot be over-tightened by hand, preventing damage to the valve. Release speed depends on how far open the knob is turned. Pressure relief is factory set to prevent crew from over-tensioning the backstay.

Harken integral backstay adjusters come in four sizes to fit boats with 5 - 10 mm (7/32 - 3/8") wire—approximately 9 - 18 m (30 - 60').



Harken recommends attaching a toggle to the cylinder's bottom clevis to accommodate stay movement. Standard eye-jaw toggles fit all Harken cylinders.



Wine & Spirits, GS 48, 14.90 m (48.9') © Fabio Taccola / Grand Soleil Yachts

Part No.	- Size	Max wire Ø		Stroke		Pin center length (closed)*		Weight**		Gap/pin Ø		Pull force ‡								Breaking load	
		in	mm	in	mm	in	mm	lb	kg	in	mm	@ 1000 psi 69 bar	@ 2000 psi 138 bar	@ 3000 psi 207 bar	@ 4000 psi 276 bar	lb	kg	lb	kg		
HCI025110345BCC.NG	-6	7/32	5.5	13.5	343	30	762	7.4	3.37	7/16	11.1	1243	564	2487	1128	3490	1692	##	##	7000	3175
HCI035130345BCC.NG	-10	9/32	7	13.5	343	30	762	7.4	3.37	1/2	12.7	1243	564	2487	1128	3490	1692	4960	2250	12364	5608
HCI040160385BCC.NG	-12	5/16	8	15.2	385	32.8	832	10.8	4.92	5/8	15.9	2098	952	4197	1904	6295	2855	##	##	20984	9518
HCI045160385BCC.NG	-17	3/8	9.5	15.2	385	32.8	832	10.8	4.92	5/8	15.9	2098	952	4197	1904	6295	2855	8394	3807	20984	9518

*For pin center length open add stroke length to pin center length closed. **Rod ends (forks) included in weights. ‡ Max relief setting is 4500 psi/310 bar.

Relief valves are preset to limit tension to recommended rigging load. Each cylinder provides a specific max pull force.



Stay Away!, Solaris 55, 16.70 m (54.79'),
Javier Soto Acebal design © Solaris Yachts

HYDRAULIC CYLINDERS

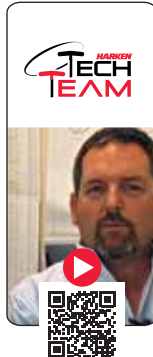

Harken offers a full range of hydraulic cylinders to handle mast, sail, and keel controls on cruising and racing yachts. Components are designed to reduce weight and size, and to increase structural strength for years of high-stress use in corrosive marine environments. They are available with -6 to -195 rod to fit everything from 9 m (30') racer/cruisers, to Grand-Prix racers, and 46 m (150')-plus megayachts. Harken-certified service centers can be found in countries around the world.



Materials:
For properties
see pages 16-17.

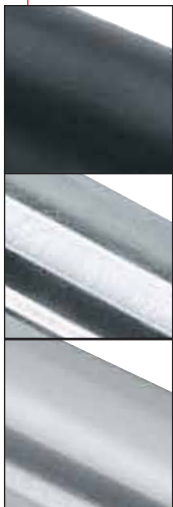

6061-T6 aluminum:
Hard Lube-anodized*
cylinder tube

316 stainless steel:
Polished cylinder
tube

Titanium:
Cylinder tube

XM-19 stainless steel:
Rod; pins



Stands up to sun, salt, and time

- Cylinder tubes in mirror-polished stainless steel, Hard Lube-anodized aluminum, or titanium.
- High-strength XM-19 stainless steel rods and pins.
- Durable, low-friction polyurethane seals and bronze-filled PTFE piston seals.
- O-rings in nonabsorbent polyurethane seals for consistent fit.

Variety of cylinder types

- Single-acting; double-pull; locking; boom vang. Single-acting cylinders have air-spring returns, but can be ordered in push, push/pull, and pull/pull custom versions.
- Custom lengths available.

Selection of rod end fittings

- Standard clevis jaw for ends included.
- Blocks and different eye types available; see alternate end fittings pages 234 and 236.
- Smooth anti-snag clevis pins protect rigging and crew.



*Clear-anodized aluminum is available, but provides less protection than Hard Lube anodizing.

DO NOT use Harken equipment for human suspension unless product is specifically certified and labeled for such use.



Locking Cylinders

Harken locking cylinders feature an adjustable mechanical lock threaded onto the rod that physically blocks rod movement and securely fixes its position independent of the boat's pressure system. They are commonly used by large cruisers on extended passages to safely lock the rod during pressure release and to act as a safety backup for the hydraulic system. In addition, a long-stroke cylinder is often used during the mast stepping process to lean the mast forward and hook up the furlers. After commissioning, the cylinder's mechanical lock is engaged, limiting the stroke for sailing.



Adjustable lock prevents rod movement during pressure release.



Solleone, Swan 115 S, 35.20 m (115.5'), Nautor's Swan, German Frers design © Carlo Borlenghi

Part No.*	- Size	Stroke		Pin center length (closed)**		Weight***		Volume		Gap/pin		Bore		Rod		Max OD	
		in	mm	in	mm	lb	kg	in ³	L	in	mm	in	mm	in	mm	in	mm
HYCL045160375BCC	-17	14.8	375	43.9	1116	11.9	5.42	31	0.51	5/8	15.9	1 3/4	45	5/8	16	2.31	59
HYCL055190400BCC	-22	15.7	400	47.6	1210	19.2	8.71	52	0.86	3/4	19.1	2 3/16	55	3/4	19	2.9	73
HYCL065220450BCC	-30	17.7	450	53.6	1362	27.2	12.36	76	1.25	7/8	22.2	2 1/2	65	7/8	22	3.2	81
HYCL075250475BCC	-40	18.7	475	58.5	1487	41.6	18.86	118	1.93	1	25.4	3	75	1	25	3.8	97
HYCL080250475BCC	-48	18.7	475	59.3	1505	49.6	22.52	129	2.11	1 1/8	28.6	3 1/8	80	1	25	4.1	103
HYCL090320550BCC	-60	21.7	550	67	1701	70.1	31.82	182	2.98	1 1/4	31.8	3 1/2	90	1 1/4	32	4.6	116
HYCL100320625BCC	-90	24.6	625	74.4	1889	98.9	44.85	279	4.57	1 3/8	34.9	4	100	1 1/4	32	5.34	136

For pull forces, see cylinder with corresponding bore and rod diameter on page 232.

*Specify rod and clevis end fittings by adding the appropriate suffix to end of part number. See page 234.

For pin center length open add stroke length to pin center length closed. *Rod ends (clevis) included in weights.

Ordering Single-Acting & Locking Cylinders

To order use the chart below. Standard cylinders are black hardcoat-anodized with clevises on both ends. Clevises, marine eyes, barrel pin eyes, and blank end fittings are offered in black hardcoat-anodized aluminum, clear-anodized aluminum, or mirror-polished stainless steel finishes. Lashing eyes and low-profile lashing cylinder end fittings are available in black hardcoat-anodized aluminum. For optional materials and fittings, replace the last three letters of the part number with your selections.

Standard Cylinder Part Number

(Standard cylinder is black hardcoat-anodized aluminum with rod clevis and cylinder-end clevis)

H Y C S 0 3 5 1 3 0 3 5 0 B C C

Hydraulic

Cylinder

Action type

S = Single-acting pull

L = Locking

Bore diameter (mm)

Rod diameter (mm)

Stroke length (mm)

Materials

B = Black hardcoat-anodized aluminum

C = Clear-anodized aluminum

S = 316 stainless steel

Rod end fittings

C = Clevis: Cylinders come standard with the clevis on rod ends.

L = Lashing eye: This soft attachment lashing has soft radii and can accept a small amount of off-axis loading.

M = Marine eye: These rigging fittings are designed to fit a standard toggle or clevis with the same size pin.

N = No fitting

Cylinder end fittings

C = Clevis: Cylinders come standard with the clevis on cylinder ends.

B = Barrel-pin eye: The barrel pin eye is used when a few degrees of side-to-side articulation is needed, allowing slight self-alignment when the cylinder is tensioned or unloaded.

L = Lashing eye: This low-profile lashing end attaches to the frame of the boat (or mast butt). Eliminating the toggle, clevis, bracket, and pins not only saves weight but space, allowing more stroke on the cylinder.

M = Marine eye: These rigging fittings are designed to fit a standard toggle or clevis with the same size pin.

X = Blank: Cylinders that attach at only one end are fitted with a blank on the unused end of the cylinder.

Materials

Hardcoat

Stainless steel

Clear-anodized

Rod End Fittings

Clevis

Lashing eye

Marine eye

No fitting

Cylinder End Fittings

Clevis

Lashing eye

Marine eye

Barrel-pin eye

Blank

Double-Pull Cylinders

Double-pull cylinders have rods on both ends and are used with mainsheet travelers or jib sheet car systems to easily adjust loaded sails. As oil is pumped into the cylinder, the rod pulls the traveler while the other rod eases. Reverse the process and the eased rod pulls the other way. Delrin® isolators separate the cylinders from the metal elements of the hull to prevent corrosion.

What makes Harken double-pull cylinders unique is the way they are installed on the boat. To take the cylinder off the mounting brackets for service, the user simply removes four screws, leaving both brackets in place.

Double-pull cylinders do not come with end fittings on the rod because of the variety of cylinder functions. On page 234, you'll find a selection of end fittings to choose from. Fittings are sold separately.



Disassembled endcap with Delrin isolator.

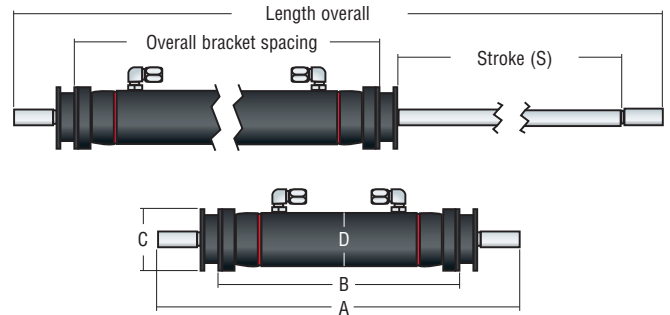

Double-Pull Cylinder Part Number

Cylinders are made to order. Specify desired stroke length in millimeters and optional end fittings when ordering.

HYCP03513xxxxBNN

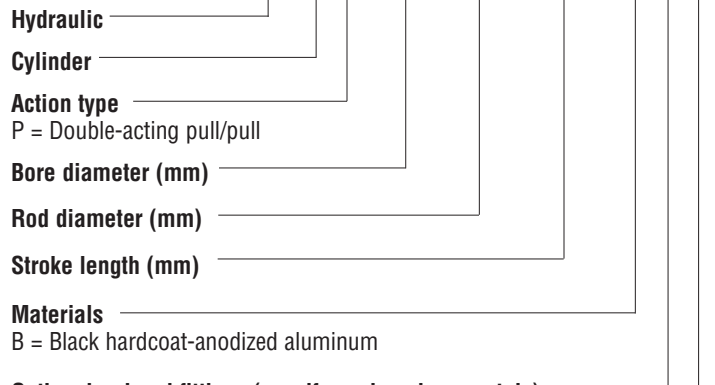

Optional rod end fittings (specify each end separately)

C, L, or N (see page 234 for options); rod end blocks (see page 236)

Delrin is a registered trademark of E. I. du Pont de Nemours and Company or its affiliates.

Part No.	- Size	Zero stroke length (A)*		Zero stroke bracket spacing (B)**		Mounting retainer Ø (C)		Outside Ø (D)		Rod thread size UNF 2A	Rod thread length		Weight	
		in	mm	in	mm	in	mm	in	mm		in	mm	lb @ zero stroke length + lb/in stroke	kg @ zero stroke length + kg/mm stroke
HYCP02511xxxxBNN	-6	11.84	300.8	8.55	217	1.6	41	2	51	7/16-20	1	25	2.07 + .14	0.94 + .002
HYCP03513xxxxBNN	-10	13.86	352	9.27	235.5	1.9	47	2.2	57	1/2-20	1.6	41	3.41 + .25	1.55 + .005
HYCP04016xxxxBNN	-12	13.56	344.5	9.03	229.4	1.9	47	2.2	57	5/8-18	1.6	41	3.87 + .33	1.76 + .006
HYCP04516xxxxBNN	-17	13.85	351.9	9.31	236.4	1.9	47	2.3	58	5/8-18	1.6	41	4.31 + .35	1.96 + .006
HYCP05519xxxxBNN	-22	15.81	401.6	10.22	259.6	2.2	55	2.9	73	3/4-16	2.1	53	7.05 + .51	3.20 + .009
HYCP06522xxxxBNN	-30	17.36	441	11.77	298.8	2.2	55	3.2	81	7/8-14	2.1	53	9.48 + .63	4.30 + .011
HYCP07525xxxxBNN	-40	22.31	566.7	14.16	359.7	3	76	3.8	97	1-12	3.2	82	16.21 + .87	7.36 + .016

*Overall cylinder length equals zero stroke length plus two times the desired stroke.

**Overall bracket spacing equals zero stroke bracket spacing plus the desired stroke.

Cylinder Blocks & Toggles

Rod End Blocks

These reverse-purchase blocks allow you to move loaded line while keeping cylinder length as short as possible, saving weight and space. They can be used anywhere a reverse purchase is needed: cunningshams, stay deflectors, travelers, and athwartship jib systems. Blocks are rigid when mounted to the rod. They are available in single, single with becket, and double versions for reverse purchases from 1:2 to 1:4.

Eye/Jaw Toggles

An eye/jaw toggle provides a cylinder with two axis points of articulation to reduce wire, rod, and end fitting fatigue. Toggles are machined from a solid bar of highly-polished 316 stainless steel and are available in 11 - 44 mm (7/16" - 1 3/4") to match cylinder pin sizes. Eye/jaw toggles are commonly sold with Harken integral backstay cylinders as well as standard cylinders used for standing rigging.

HYDRAULICS Q&A

WHY AREN'T THE SHEAVES ON YOUR CYLINDER ROD END DOUBLE BLOCKS STACKED?

Although slightly longer than blocks with stacked sheaves, our reverse purchase rod end blocks allow the sheaves to align the load directly with the cylinder, preventing premature wear and seal failure.



HYCBS11
HYCBS13
HYCBS16
HYCBS19
HYCBS22

HYCBB16
HYCBB19
HYCBB22

HYCBD11
HYCBD13
HYCBD16
HYCBD19
HYCBD22

ROD END BLOCKS



EYE/JAW TOGGLES

Eye/Jaw Toggles

Part No.	Jaw/pin Ø		Length		Fits bore/rod Ø mm
	in	mm	in	mm	
HYHTEJS11	7/16	11.1	2.0	50.8	25/11
HYHTEJS13	1/2	12.7	2.2	55.9	35/13
HYHTEJS16	5/8	15.9	2.5	63.5	40/16 & 45/16
HYHTEJS19	3/4	19.1	2.9	73.7	55/19
HYHTEJS22	7/8	22.2	3.3	83.8	65/22
HYHTEJS25	1	25.4	3.7	94	75/25
HYHTEJS29	1 1/8	28.6	4.1	104.1	80/25
HYHTEJS32	1 1/4	31.8	4.5	114.3	90/32
HYHTEJS35	1 3/8	34.9	5.6	142.2	100/32
HYHTEJS38	1 1/2	38.1	5.7	144.5	115/35
HYHTEJS44	1 3/4	44.5	7.2	182.6	130/38

Rod End Blocks

Part No.	Description	Fits rod Ø	Rod thread size	Sheave Ø		Length		Reverse purchase
		mm	UNF A	in	mm	in	mm	
HYCBS11	Single	11	7/16-20	2.0	52	4.0	101	1:2
HYCBD11	Double*	11	7/16-20	2.0, 1.3	52, 33	5.5	139	1:3, 1:4
HYCBS13	Single	13	1/2-20	2.0	52	4.0	101	1:2
HYCBD13	Double*	13	1/2-20	2.0, 1.3	52, 33	5.5	139	1:3, 1:4
HYCBS16	Single	16	5/8-18	3.2	82	5.2	132	1:2
HYCBB16	Single/becket	16	5/8-18	3.2	82	7.4	188	1:3
HYCBD16	Double	16	5/8-18	3.2, 2.0	82, 52	7.5	189	1:4
HYCBS19	Single	19	3/4-16	3.2	82	5.7	144	1:2
HYCBB19	Single/becket	19	3/4-16	3.2	82	7.9	200	1:3
HYCBD19	Double	19	3/4-16	3.2, 2.0	82, 52	7.9	201	1:4
HYCBS22	Single	22	7/8-14	4.3	108	7.4	189	1:2
HYCBB22	Single/becket	22	7/8-14	4.3	108	10.8	275	1:3
HYCBD22	Double	22	7/8-14	4.3, 3.2	108, 82	10.9	278	1:4

Maximum working load is equal to maximum pull force for appropriately sized cylinder.

*Can be used as becket block.

Boom Vangs

Hydraulic vang change the height of the boom to help control sail shape. They also function as a topping lift to hold the boom up when reefing, and to keep it level when the sail is flaked. Harken offers a full range of vang cylinders. The HYCV single-acting gas return is the standard vang used for most boats up to approximately 23 m (75'). For larger yachts with heavier booms Harken offers more powerful push/pull double-acting vangs. The standard double-acting vang is the HYCZ push/pull vang.

Megayacht Antibuckling Double-Acting Boom Vangs

High-tech hulls and rigging plus larger roller furling booms have dramatically increased the compression loads on boom vangs of the increasingly larger modern day megayacht. This overload can result in the cylinder rod buckling, causing the vang to malfunction. Harken engineers solved this issue by eliminating the load on the rod and transferring the load to the outer housing tube. Harken is in the process of redesigning these larger vangs in order to offer more sizes and improved features. Please contact Harken for more information on the new design.

Ordering Boom Vangs

All vangs are made to order. Specify desired PCLC (pin center length closed) in millimeters rounded to the nearest 10th. Standard vangs are black hardcoat-anodized aluminum with rod clevis and cylinder end clevis.



Double-acting vang cylinder

Boom Vang Cylinder Part Number

HYCV040220255BCCXXX

Hydraulic
Cylinder

Action Type

G = Double-acting vang
with anti-buckling tube
V = Single-acting vang
Z = Double-acting vang

Bore Diameter (mm)

Rod Diameter (mm)

Stroke Length (mm)

Materials

B = Black hardcoat-anodized aluminum
C = Clear-anodized aluminum
P = Painted aluminum

Rod End Fittings

C = Clevis

Cylinder End Fittings

C = Clevis

PCLC (mm)



STANDARD BOOM VANGS



MEGAYACHT BOOM VANGS



Boom Vangs

The compression force limit graph shown below indicates the maximum allowable compression force for a given PCLC (pin center length closed). The maximum allowable compression force decreases as the PCLC increases. The loading information chart to the right shows the maximum return push force at 600 psi.

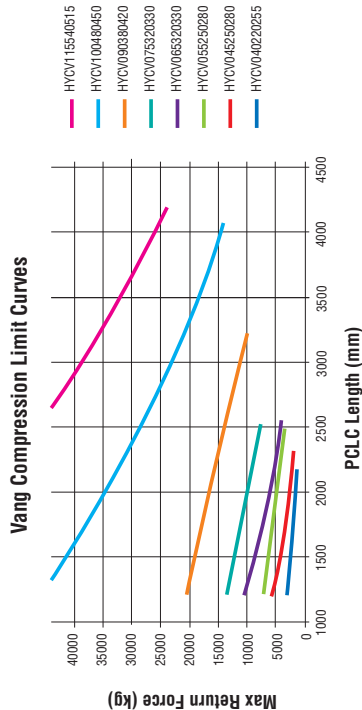

Loading Information

Part No.	@ 1000 psi 69 bar				@ 2000 psi 138 bar				@ 3000 psi 207 bar				@ 4000 psi 276 bar				@ 5000 psi 345 bar				@ 600 psi 41 bar**				
	-	Size	lb	kg	lb	kg	lb	kg	lb	kg	lb	kg	lb	kg	lb	kg	lb	kg	lb	kg	lb	kg	lb	kg	
Single-Acting																									
HYCV040220255	-12	106	48	1271	577	2437	1105	3603	1634	4769	2163	1060	481												
HYCV045250280	-17	177	80	1797	815	3416	1550	5036	2284	6656	3019	1443	655												
HYCV055250280	-22	718	326	3691	1674	6664	3023	9636	4371	12609	5719	2255	1023												
HYCV065320330	-30	736	334	4418	2004	8099	3674	11781	5344	15463	7014	2945	1336												
HYCV075320330	-40	1600	726	7442	3375	13283	6025	19124	8675	24966	11324	4241	1924												
HYCV090380420	-60	2081	944	9835	4507	17789	8069	25643	11632	33497	15194	5773	2618												
HYCV100480450	-90	2265	1028	12071	5475	1876	9923	31681	14370	41486	18818	7540	3420												
HYCV115540515	-110	2815	1277	15173	6882	27531	12488	39888	18093	52246	23698	9543	4328												
Double-Acting																									
HYCV065320330	-30	3682	1670	7363	3340	11045	5010	14726	6680	18408	8350	*	*												
HYCV075320330	-40	5841	2650	11683	5299	17524	7949	23366	10598	29207	13248	*	*												
HYCV090380420	-60	7854	3563	15708	7125	23562	10688	31416	14250	39270	17813	*	*												
HYCV100480450	-90	9805	4448	19610	8895	29416	13343	39221	17790	49026	22238	*	*												
HYCV115540515	-110	12358	5605	24715	11211	37073	16816	49431	22422	61789	28027	*	*												

*Return force varies based on oil pressure and buckling strength for different PCLCs.
**600 psi is the standard return gas pressure; maximum allowed is 1000 psi.

Part No.	Stroke	Pin center length closed (PCLC)	Weight		Volume		Gap/in	Bore	Diameter Rod	Housing OD	Extension tube OD												
			Base weight lb + (PCLC x lb/in)	Base weight kg + (PCLC x kg/mm)	Retracted	Extended						in	mm	in	mm	in	mm						
Single-Acting																							
HYCV040220255	-12	10.0	254	55	1397	89	2260	2.940 + 0.126	1.33 + 0.00225	12	0.19	5/8	15.9	1 1/2	40	7/8	22	1.98	50	1.98	50		
HYCV045250280	-17	11.0	279	55	1397	100	2540	4.965 + 0.131	2.25 + 0.00234	18	0.29	5/8	15.9	1 3/4	45	1	25	2.27	58	2.19	56		
HYCV055250280	-22	11.0	279	55	1397	104	2640	4.026 + 0.244	1.83 + 0.00436	33	0.54	5/8	15.9	2 3/16	55	1	25	2.86	73	2.50	64		
HYCV065320330	-30	13.0	330	55	1397	107	2720	9.139 + 0.263	4.15 + 0.00470	48	0.78	3/4	19.1	2 1/2	65	1 1/4	32	3.17	81	2.86	73		
HYCV075320330	-40	13.0	330	55	1397	116	2960	13.076 + 0.300	5.93 + 0.00535	76	1.24	7/8	22.2	3	75	1 1/4	32	3.80	97	3.17	81		
HYCV090380420	-60	16.5	419	55	1397	152	3860	22.092 + 0.449	10.02 + 0.00802	130	2.12	1	25.4	3 1/2	90	1 1/2	38	4.57	116	3.86	98		
HYCV100480450	-90	17.8	451	65	1651	180	4570	36.369 + 0.666	16.50 + 0.01189	174	2.85	1 1/4	31.8	4	100	1 7/8	48	5.34	136	4.57	116		
HYCV115540515	-110	20.3	515	70	1778	183	4620	48.320 + 0.963	21.92 + 0.01720	250	4.1	1 3/8	34.9	4 1/2	115	2 1/8	54	6.00	152	5.34	136		
Double-Acting																							
HYCV065320330	-30	13.0	330	55	1397	103	2620	9.819 + 0.263	4.45 + 0.00470	48	0.78	64	1.05	3/4	19.1	2 1/2	65	1 1/4	32	3.17	81	2.86	73
HYCV075320330	-40	13.0	330	55	1397	112	2860	13.996 + 0.300	6.35 + 0.00535	76	1.24	92	1.51	7/8	22.2	3	75	1 1/4	32	3.80	97	3.17	81
HYCV090380420	-60	16.5	419	55	1397	144	3650	23.573 + 0.449	10.69 + 0.00802	130	2.12	159	2.6	1	25.4	3 1/2	90	1 1/2	38	4.57	116	3.86	98
HYCV100480450	-90	17.8	451	65	1651	167	4250	38.419 + 0.666	17.43 + 0.01189	174	2.85	223	3.66	1 1/4	31.8	4	100	1 7/8	48	5.34	136	4.57	116
HYCV115540515	-110	20.3	515	70	1778	183	4650	49.360 + 0.964	22.39 + 0.01722	250	4.1	322	5.28	1 3/8	34.9	4 1/2	115	2 1/8	54	6.00	152	5.34	136

Grand-Prix Cylinders

Used for mast, sail, and keel controls, Harken Grand-Prix cylinders were specifically designed to withstand the stresses of high-intensity racing. Their longevity and reliability are evident in the selection of high-quality materials and components.

Cylinder housings are machined from aerospace grade titanium. High-strength stainless steel rods provide superior strength and corrosion resistance. 10,000 psi cylinders are available upon request.

Cylinders are offered with clevis jaws and a variety of fittings. Available in push, pull, pull/pull and push/pull styles.

Grand-Prix cylinders are only intended for systems with a vigorous maintenance schedule, as they are built for extremely high loads at a minimal weight.

All Grand Prix cylinders are made to order

To order, specify stroke length in millimeters, and rod and cylinder end fitting options. Contact Harken for weights and volumes.



Custom titanium mast ram



Grand-Prix cylinder with spherical end cap



TP52 © Max Ranchi

Part No.*	Bore Ø		Rod Ø		Pull force**			
	in	mm	in	mm	@ 5000 psi/345 bar		@ 7500 psi/517 bar	
					lb	kg	lb	kg
HYCS01906xxxx	3/4	19	1/4	6	1963	891	2945	1336
HYCS02508xxxx	1	25	5/16	8	3543	1607	5315	2411
HYCS02910xxxx	1 1/8	29	3/8	10	4418	2004	6627	3006
HYCS03210xxxx	1 1/4	32	3/8	10	5584	2533	8376	3799
HYCS03511xxxx	1 3/8	35	7/16	11	6673	3027	10009	4540
HYCS04011xxxx	1 1/2	40	7/16	11	8084	3667	12126	5500
HYCS04513xxxx	1 3/4	45	1/2	13	11045	5010	16567	7515
HYCS04814xxxx	1 7/8	48	9/16	14	12563	5699	18845	8548
HYCS05014xxxx	2	50	9/16	14	14465	6561	21698	9842
HYCS05516xxxx	2 3/16	55	5/8	16	17257	7828	25886	11742
HYCS06018xxxx	2 3/8	60	11/16	18	20295	9205	30442	13808
HYCS06519xxxx	2 1/2	65	3/4	19	22335	10131	33502	15196
HYCS07021xxxx	2 3/4	70	13/16	21	27105	12295	40658	18442
HYCS07522xxxx	3	75	7/8	22	32336	14667	48504	22001
HYCS08022xxxx	3 1/8	80	7/8	22	35343	16031	53014	24047
HYCS09025xxxx	3 1/2	90	1	25	44179	20039	66268	30059

Contact Harken to request quote and lead time. *Specify material choice and rod and clevis end fittings by adding appropriate 3-letter code to end of part number. See page 234.

**Maximum air return force ratio is 10:1, not included in pull force calculation. Precharge is a maximum of 100 psi (6.9 bar).





Beau Geste, IRC 52, Cookson Boats, Botin Partners Naval Architecture © Paul Stubbs

HYDRAULIC CONTROL VALVES & MANIFOLDS

Harken offers a complete line of extremely lightweight, low-profile valves and manifolds for hydraulically-controlled systems. Harken standard valves are half the weight of most styles, with Grand-Prix versions sculpted to further eliminate unnecessary material. An independent pressure-relief function in each valve gives crew the ability to match hydraulic power to the maximum working load of individual mast and sail controls. An adjustable flow control integrated into each valve fine-tunes the speed of release.



High-strength, lightweight

- Valves, manifolds, standard valve panels corrosion-resistant, hardcoat-anodized aluminum; stainless fittings for strength.
- Lightweight composite handles textured, contoured for secure grip.

Valves with independent relief, release, and flow match system loads

- Each valve has independent pressure relief for individualized pressure adjustment.
- Each valve has integrated adjustable flow control for fine-tuning release speed.
- Minimum flow rate of 8 L/min (2.1 gpm).
- Pressure relief and release combined into one part saves weight.





MVP valve panels



Valve handles fit in four directions for easy operation

- Inverted handles on double-sided manifolds have same open/closed positions; rotation direction for easy access.
- Valve stems have tapered shaft to fit handle socket for secure, tight fit.

Service available worldwide

- Service and repairs should be done by certified hydraulic technician.
- Valve seal and repair kits available worldwide.
- 3-micron high-pressure filter to protect equipment recommended.



Options

- Standard valves and manifolds handle up to 5,000 psi; sculpted Grand-Prix valves and manifolds handle up to 10,000 psi.
- Valves offered with short and long shafts: short shaft fits 3 mm-thick deck/panel; long shaft 4 mm to 25 mm-thick deck/floor.
- Double-acting valves for traveler controls, other functions using twin or double-acting cylinders.
- Inline relief valves: control maximum system pressure; inline relief valves work with any manual system, manifold-mount reliefs fit Harken manifolds.
- Remote dump valves: ease sail controls from helm, rail, other positions on boat; use as quick release or regulate speed with optional adjustable flow control.

- Valve panels: offered with/without gauges for Harken manifold configurations.
- Valve panels in clear- or hardcoat-anodized aluminum, stainless steel, and clear-coated carbon.
- Single- and double-sided manifolds accommodate up to nine valves for multiple functions.



Valves & Manifolds



HYV1GP



HYV1PP



HYV2GP



HYV2PP



HYVDSPF

SINGLE-ACTING VALVES

DOUBLE-ACTING VALVES

DUMP VALVE



HYMZG63



HYMSG62



HYMSP62



HYKMB

MANIFOLDS

Use a blanking kit to maintain the functionality of your hydraulic system when a valve is removed. Kits include O-rings and bolts.

HYVRM

RELIEF VALVE

Part No.	Description	Max pressure		Height		Width		Depth		Weight	
		psi	bar	in	mm	in	mm	in	mm	lb	kg
Valves											
HYV1PP	Single-acting panel mount valve	5000	345	3.9	100	1.9	47	2.6	66	0.7	0.31
HYV1PT	Single-acting through-deck mount valve	5000	345	3.9	100	1.9	47	3.7	95	0.7	0.34
HYV2PP	Double-acting panel mount valve	5000	345	3.9	100	2.5	63	3.7	95	1.6	0.75
HYV2PT	Double-acting through-deck mount valve	5000	345	3.9	100	2.5	63	4.9	124	1.7	0.78
HYV1GP	Single-acting Grand-Prix panel mount valve	10000	689	3.9	100	1.9	47	2.6	66	0.5	0.23
HYV1GT	Single-acting Grand-Prix through-deck mount valve	10000	689	3.9	100	1.9	47	3.7	95	0.6	0.26
HYV2GP	Double-acting Grand-Prix panel mount valve	10000	689	3.9	100	2.5	63	3.7	95	1	0.45
HYV2GT	Double-acting Grand-Prix through-deck mount valve	10000	689	3.9	100	2.5	63	4.9	124	1.1	0.48
HYVDSPF	Remote dump valve/string pull/flow control	10000	689	2.4	60	1.7	42	0.7	19	0.2	0.08
HYVDPBF	Push-button dump valve/flow control	10000	689	3.8	97	2.2	56	2.8	70	0.3	0.15
HYVRI	Relief valve/inline	10000	689	1.4	36	1.0	25	3.0	75	0.2	0.08
HYVRM	Relief valve/manifold mount	10000	689	1.1	28	1.1	28	2.8	72	0.2	0.1
HYKMB	Manifold blanking plate kit	10000	689	0.3	8	1.2	31	1.3	33	0.1	0.03
Manifolds											
HYMSP61	Single-sided manifold 1 place	5000	345	0.7	19	2.2	55	1.5	38	0.2	0.08
HYMSP62	Single-sided manifold 2 place	5000	345	0.7	19	5.4	137	1.5	38	0.5	0.22
HYMSP63	Single-sided manifold 3 place	5000	345	0.7	19	8.7	220	1.5	38	0.8	0.37
HYMSP64	Single-sided manifold 4 place	5000	345	0.7	19	11.9	302	1.5	38	1.1	0.51
HYMSP65	Single-sided manifold 5 place	5000	345	0.7	19	15.2	385	1.5	38	1.4	0.65
HYMSG61	Single-sided Grand-Prix manifold 1 place	10000	689	0.7	19	1.7	42	1.5	38	0.1	0.05
HYMSG62	Single-sided Grand-Prix manifold 2 place	10000	689	0.7	19	5.4	137	1.5	38	0.3	0.15
HYMSG63	Single-sided Grand-Prix manifold 3 place	10000	689	0.7	19	8.7	220	1.5	38	0.5	0.22
HYMSG64	Single-sided Grand-Prix manifold 4 place	10000	689	0.7	19	11.9	302	1.5	38	0.6	0.29
HYMSG65	Single-sided Grand-Prix manifold 5 place	10000	689	0.7	19	15.2	385	1.5	38	0.8	0.36
HYMZG63	Double-sided Grand-Prix manifold 3 place	10000	689	0.7	19	5.4	137	1.5	38	0.3	0.16
HYMZG64	Double-sided Grand-Prix manifold 4 place	10000	689	0.7	19	7.0	178	1.5	38	0.4	0.2
HYMZG65	Double-sided Grand-Prix manifold 5 place	10000	689	0.7	19	8.7	220	1.5	38	0.5	0.24
HYMZG66	Double-sided Grand-Prix manifold 6 place	10000	689	0.7	19	10.3	261	1.5	38	0.6	0.28
HYMZG67	Double-sided Grand-Prix manifold 7 place	10000	689	0.7	19	11.9	302	1.5	38	0.7	0.32
HYMZG68	Double-sided Grand-Prix manifold 8 place	10000	689	0.7	19	13.5	344	1.5	38	0.8	0.36
HYMZG69	Double-sided Grand-Prix manifold 9 place	10000	689	0.7	19	15.2	385	1.5	38	0.9	0.39

Standard valves have -4 JIC port adapters. Grand Prix valves have plugs in all ports.

Ordering Valve Assemblies

Use this guide to configure your valve assembly order. Standard valve assemblies come with the “J” port fitting option, and Grand-Prix assemblies come with “X” port fitting. For other fitting options, replace the last letter of the part number with your selection.

Valve Assembly Part Number

HYA2000RGXXXJ

Hydraulic valve assembly

Valves on manifold:

2__ = Number of single-acting valves on top

_0__ = Number of double-acting valves on top

__0_ = Number of single-acting valves on bottom

___0 = Number of double-acting valves on bottom

Relief:

X = No relief

R = Manifold relief

I = In-line relief

Valve/manifold type:

G = Grand Prix/sculpted

P = Standard

Number of gauges:

X = No gauges

G = One gauge for each valve

Panel type:

X = No panel, short shaft

T = No panel, long shaft

B = Black hardcoat-anodized aluminum panel

C = Clear-anodized aluminum panel

F = Carbon fiber panel

S = 316 stainless steel panel

Pump:

X = No pump

1 = 1-speed pump

2 = 2-speed pump

3 = 3-speed pump

Port fittings:

A = Stainless steel 1/4" A-lock pressure port and
-6 JIC anodized aluminum supply/return port

J = Stainless steel -4 JIC pressure port and
-6 brass hose barb supply/return port

X = Plugs on all ports*

Two single-acting valves on top

HYA2000RGXXXJ

JIC adapter

Manifold-mount relief valve

Grand Prix sculpted valves and manifold

Two single-acting valves on top

One gauge for each valve



Black hardcoat-anodized aluminum panel

HYA2000RPGXJ

*Other fittings available. Contact Harken.



MVP-1 Single Control & MVP-4 Multi Control Panels



Valve Panels



Harken single and multifunction valve panels are used by larger cruisers to control systems like backstays, boom vang, and outhauls. Available as kits, single-function panels are offered with 2-liter reservoirs, multifunction panels with 4-liter reservoirs. Both panels come with pumps, handles, gauge, pressure relief, and release functions. Panels come standard with a 1- or 2-speed pump. A 3-speed pump is available on request.

The single-function valve is a simple on/off system that can operate the cylinder remotely, allowing the user to tension the backstay cylinder from the cockpit. Multifunction panels can operate up to four cylinders remotely, with a selector handle choosing 1 of 4 functions. Valve panels feature an easy-to-read gauge and a finger-controlled knob for pressure release.

Single and multifunction panels come standard in black hardcoat-anodized 6061-T6 aluminum. Panels also offered in clear-anodized aluminum, stainless steel, or carbon fiber.



Kit includes multi- or single-function control panel, pump handle, reservoir, low-pressure hose, and suction filter.



Back of valve panel



Hardcoat-anodized aluminum



Clear-anodized aluminum



Carbon fiber



Stainless steel



MVP-1 SINGLE CONTROL PANEL



MVP-4 MULTI CONTROL PANEL

Part No.	Description	Length		Width		Depth		Weight		
		in	mm	in	mm	in	mm	lb	kg	
MVP-4 Multi Control										
HYAMXPGB2J	4-function panel/hardcoat-anodized aluminum/2-speed	9 1/4	235	11 1/2	292	5 3/4	146	8.5	3.85	
HYAMXPGC2J	4-function panel/clear-anodized aluminum/2-speed	9 1/4	235	11 1/2	292	5 3/4	146	8.5	3.85	
HYAMXPGS2J	4-function panel/stainless steel/2-speed	9 1/4	235	11 1/2	292	5 3/4	146	11.9	5.4	
HYAMXPGF2J	4-function panel/carbon fiber/2-speed	9 1/4	235	11 1/2	292	5 3/4	146	7.8	3.53	
HYAMXPGB1J	4-function panel/hardcoat-anodized aluminum/1-speed	9 1/4	235	11 1/2	292	5 3/4	146	7.4	3.34	
HYAMXPGC1J	4-function panel/clear-anodized aluminum/1-speed	9 1/4	235	11 1/2	292	5 3/4	146	7.4	3.34	
HYAMXPGS1J	4-function panel/stainless steel/1-speed	9 1/4	235	11 1/2	292	5 3/4	146	10.7	4.86	
HYAMXPGF1J	4-function panel/carbon fiber/1-speed	9 1/4	235	11 1/2	292	5 3/4	146	6.6	2.99	
MVP-1 Single Control										
HYASXPGB2J	Single-function panel/hardcoat-anodized aluminum/2-speed	9 1/4	235	11 1/2	292	5 3/4	146	6.9	3.13	
HYASXPGC2J	Single-function panel/clear-anodized aluminum/2-speed	9 1/4	235	11 1/2	292	5 3/4	146	6.9	3.13	
HYASXPGS2J	Single-function panel/stainless steel/2-speed	9 1/4	235	11 1/2	292	5 3/4	146	10.3	4.68	
HYASXPGF2J	Single-function panel/carbon fiber/2-speed	9 1/4	235	11 1/2	292	5 3/4	146	6.2	2.81	
HYASXPGB1J	Single-function panel/hardcoat-anodized aluminum/1-speed	9 1/4	235	11 1/2	292	5 3/4	146	5.7	2.59	
HYASXPGC1J	Single-function panel/clear-anodized aluminum/1-speed	9 1/4	235	11 1/2	292	5 3/4	146	5.7	2.59	
HYASXPGS1J	Single-function panel/stainless steel/1-speed	9 1/4	235	11 1/2	292	5 3/4	146	9.1	4.14	
HYASXPGF1J	Single-function panel/carbon fiber/1-speed	9 1/4	235	11 1/2	292	5 3/4	146	5	2.27	

Compact Control Panel

Harken's Compact Control Panel provides sailors with a single-speed, single-function panel pump for remote cylinder operation. This no-frills model is clean and uncomplicated, with the same quality you expect from a Harken hydraulic product. The double-acting pump delivers oil when the pump handle is pushed and pulled, moving oil efficiently through the system. The panel's pressure-release knob cannot be over-tightened by hand and cause damage to the valve. Pressure relief is factory-set at a maximum 5000 psi to prevent crew from over-tensioning the system. The panel's small footprint takes up very little space, providing a variety of mounting options. The wide bolt pattern on the pump minimizes stress and stabilizes the pump.

The kit comes with pump, valve manifold, 2-liter tank, handle, filter, and hose.

Available in black hardcoat-anodized 6061-T6 aluminum.



Back of valve panel



Compact Control Panel

Part No.	Description	Length		Width		Depth		Weight	
		in	mm	in	mm	in	mm	lb	kg
HYACFPXB1J	Compact single-function panel/hardcoat-anodized/1-speed	9	229	6 1/2	165	2 9/16	65	5	2.27

Pump Handles

Handles mount at the angle you choose. Standard round-tipped handles are made of knurled 6061-T6 hardcoat-anodized aluminum and fit most marine pumps. Grand-Prix versions are available in carbon fiber. An optional square-tipped style allows the handle to be rocked 5 degrees laterally from the pumping direction to store against the cockpit wall.



CARBON FIBER HANDLE



ALUMINUM HANDLE

Pump Handles

Part No.	Description	Ø		Length		Weight	
		in	mm	in	mm	lb	kg
HYPMH6600	Pump handle 600 mm/aluminum	1 1/4	32	23 5/8	600	1.2	0.56
HYPMH6800	Pump handle 800 mm/aluminum	1 1/4	32	31 1/2	800	1.5	0.7
HYPMHC800	Pump handle 800 mm/carbon fiber	1 1/4	32	31 1/2	800	1.0	0.45
HYPMHC800S	Pump handle 800 mm/carbon fiber/square tip	1 1/4	32	31 1/2	800	1.0	0.45
HYPMHC1000	Pump handle 1000 mm/carbon fiber	1 1/4	32	39 3/8	1000	1.2	0.53
HYPMHC1000S	Pump handle 1000 mm/carbon fiber/square tip	1 1/4	32	39 3/8	1000	1.2	0.53

Hydraulic Pumps

Harken offers 1-, 2-, and 3-speed pumps for hydraulic systems. Our 2- and 3-speed pumps deliver oil faster and more efficiently than other pumps on the market. When a preset point is reached, the pump automatically shifts to the next speed. The 1-speed pump is a simpler alternative, but features the same high-quality components as the other systems. Use 1- and 2-speed pumps for smaller and midsize hydraulic systems; 3-speed pumps on systems with high-volume, high-pressure requirements. Pressure relief on 1- and 2-speed pumps is factory-set to a maximum of 5000 psi. Mounting patterns for all pumps are identical, making upgrades easy.

Bolt holes in the hardcoat-anodized 6061-T6 aluminum pump housing are threaded with stainless steel inserts to prevent corrosion around the stainless bolts. An optional adhered isolation plate improves load distribution even more by transferring torque directly to the mounting surface rather than the bolt holes. Piston shafts and rocker arms are machined from 17-4 PH stainless steel. Pumps have 7-degree splined shafts to ensure a tight fit and to allow the handle to be mounted at the sailor's preferred angle.



Optional isolation plates made of extremely resilient G10 improve load distribution by transferring torque directly to the mounting surface.



1-SPEED PUMP



2-SPEED PUMP



3-SPEED PUMP



Timbalero 3, G4, 12.14 m (39.83'), DNA Performance Yachts

Part No.	Description	Output/stroke (push and pull)						Max pressure		Ports/fittings		Weight	
		1st		2nd		3rd		psi	bar	Suction	Pressure	lb	kg
		in ³	cc	in ³	cc	in ³	cc						
HYPM1	1-speed pump with pressure relief*	0.25	4.1					5000	345	3/8" hose barb	1/4" 37° JIC	3.2	1.44
HYPM2	2-speed pump/auto shift with pressure relief*	0.99	16.3	0.25	4.1			5000	345	3/8" hose barb	1/4" 37° JIC	4.3	1.95
HYPM3-1.1R	3-speed pump/auto shift/round handle socket*	2.03	33.3	0.61	10.1	0.18	3	10000	689	3/8" NPT	7/16" ORB	4.4	2
HYPM3-1.1S	3-speed pump/auto shift/square handle socket*	2.03	33.3	0.61	10.1	0.18	3	10000	689	3/8" NPT	7/16" ORB	4.4	2
HYPM3MP	Pump anti-torque mounting plate											0.1	0.07

*M8 fasteners.

Hydraulic Rotary Pumps

Harken offers three sizes of multi-speed, pedestal-driven rotary pumps for Grand-Prix race boats 13.7 - 30.5 m (45 - 100'). They deliver oil faster, more efficiently, and with higher shift points than other pumps of comparable sizes. The 10 and 20 cc pumps shift from 1st to 2nd gear both automatically and manually, with automatic shift points determined by the maximum output of the grinders. If fewer crew are grinding, and not enough power is generated to reach the automatic shift point, pumps can be shifted manually—the 20 cc pump by simply reversing the pedestal handles; the 10 cc pump by using a pull-cord attached to a lever.

Pumps are made of corrosion-resistant Hard Lube-anodized aluminum, with aluminum, titanium, and stainless steel components. All pumps include a non-return valve on the outlet to prevent backflow.

10 cc Pumps

A female spline attaches these pumps directly to the pedestal and is compatible with Harken's MX. Six double-stepped pistons save weight and feature connecting rods for piston return instead of springs. Three fasteners provide quick connect/disconnect mounting. Spinning these pumps in either direction results in the same displacement.

20 cc Pumps

These patented pumps have either a 30 mm male input shaft or 25 mm female spline. Two banks of six pistons feature spring returns and large volume output. Spinning these pumps in the opposite direction at a pressure lower than the automatic shift point manually shifts them into second gear. Please specify clockwise (CW) or counterclockwise (CCW) when ordering.

26 cc Pumps

Harken's electrically-shifting, three-speed rotary pumps deliver up to 15.9 L/min at 600 rpm. Four fasteners easily mount these pumps to a two-speed planetary gearbox with several ratio options to deliver up to six hydraulic displacements on one pedestal. Offset radial pistons ensure these pumps will deliver a very smooth and efficient flow of oil to hydraulic functions. Spinning these pumps in the opposite direction will engage the speed-up ratio in the gearbox, or deliver the pedestal ratio. Please specify clockwise (CW) or counterclockwise (CCW) when ordering.



Female splines attach directly to Harken's MX pedestal for a tight connection.



Male input shafts attach pumps to bevel boxes or pedestals and can mount remotely.



10 CC PUMPS



20 CC PUMPS



26 CC PUMPS

Part No.	Description	Output / revolution						Max pressure		Input spline	Ports/fittings		Weight		
		1st in ³	1st cc	2nd in ³	2nd cc	3rd in ³	3rd cc	RPM	psi		bar	Suction	Pressure	lb	kg
10 cc Pumps															
HYPR262	2-speed pump	0.61	10.4	0.26	4.3			400	7500	517	25 mm female spline	3/8" 37° JIC	1/4 37° JIC	6.3	2.85
20 cc Pumps															
HYPR212	2-speed pump/CCW*	1.25	20.5	0.39	6.3			400	7500	517	30 mm male input shaft	3/8" 37° JIC	3/8" 37° JIC	10.2	4.64
HYPR212L	2-speed pump/CW*	1.25	20.5	0.39	6.3			400	7500	517	30 mm male input shaft	3/8" 37° JIC	3/8" 37° JIC	10.2	4.64
HYPR212MX	2-speed pump/CCW*	1.25	20.5	0.39	6.3			400	7500	517	25 mm female spline	3/8" 37° JIC	3/8" 37° JIC	9.9	4.5
HYPR212MXL	2-speed pump/CW*	1.25	20.5	0.39	6.3			400	7500	517	25 mm female spline	3/8" 37° JIC	3/8" 37° JIC	9.9	4.5
26 cc Pumps															
HYPR320MX5K	3-speed pump	1.62	26.6	1.01	16.6	0.61	10	600	5000	345	30 mm male input shaft	3/4" 37° JIC	3/8" 37° JIC	15.3	6.95

*M8 fasteners.



Hydraulic Reservoirs

Harken offers pressurized carbon fiber/composite reservoirs and vented blow-molded reservoirs for manual hydraulic systems.

Pressurized Reservoirs

All Harken pressurized reservoirs have translucent sections in the reservoir walls, making it easy to monitor oil levels. Pressurized reservoirs require very little maintenance and are cleaner than those that use ambient air pressure. They can be installed in the bilge rather than at pump level to provide a low center of gravity.

Grand-Prix Pressurized Reservoirs

Harken offers four sizes of Grand-Prix pressurized reservoirs (20-, 17-, 13-, and 10-liter) to suit any Grand Prix need. They are among the lightest in existence.

Reservoirs can be built with up to three ports on each end, customizable to whatever application is required. Port sizes are offered from -16 JIC down to -6 JIC. One-way return-line check valves, supply-line shutoff valves, and high quality regulators are available to meet specific needs.

Custom sizes and configurations are available. Contact Harken.

Vented Reservoirs

These 2- and 4-liter blow-molded reservoirs are used for smaller Grand Prix systems and production yachts. Reservoirs feature a vented cap to stabilize tank pressure and prevent leaks. Translucent materials allow oil levels to be easily monitored. 10 mm (3/8") hose barbs are welded to the reservoir for supply and return hoses.

Grand-Prix Pressurized Reservoir Part Number

HYRPC20XXGXAB

Pressurized reservoirs

Size in liters:

- 10
- 13
- 17
- 20

Ports on top / Ports on bottom:

- X = None
- A = -6 JICm
- B = -8 JICm
- C = -12 JICm
- D = -16 JICm
- E = Custom
- G = Gauge
- N = Non-return check valve
- R = Regulator with gauge
- V = Ball valve



VENTED RESERVOIRS



PRESSURIZED RESERVOIRS



GRAND-PRIX PRESSURIZED RESERVOIRS

Part No.	Description	Maximum capacity		Oil capacity		Height		Maximum dimensions		Depth		Weight	
		gal	L	gal	L	in	mm	in	mm	in	mm	lb	kg
HYRPC02	Pressurized composite reservoir	0.5	2	0.32	1.2	12.2	310	6.3	160	5.8	148	2.1	0.97
HYRPC03	Pressurized composite reservoir	0.8	3	0.46	1.7	15.2	386	6.3	160	5.8	148	2.5	1.12
HYRPC04	Pressurized composite reservoir	1.1	4	0.63	2.4	17.9	455	6.3	160	5.8	148	2.8	1.28
HYRPC06	Pressurized composite reservoir	1.6	6	0.6	3.5	25.2	640	6.3	160	5.8	148	3.5	1.59
HYRPC08	Pressurized composite reservoir	2.1	8	1.2	4.7	31.2	793	6.3	160	5.8	148	4.3	1.96
HYRPC10	Pressurized composite reservoir	2.6	10	1.6	5.9	37.2	946	6.3	160	5.8	148	5.2	2.34
HYRVP02	Vented blow-molded reservoir	0.5	2	0.4	1.5	7.1	181	8.7	220	4.1	105	0.8	0.36
HYRVP04	Vented blow-molded reservoir	1.1	4	0.8	3	11.7	298	8.7	220	4.1	105	1.2	0.55

Hydraulic Accessories

Harken offers a complete range of high-quality kits and components for the professional installation, service, and maintenance of your hydraulic system.

Filters

Filtration is essential to the health and longevity of your hydraulic system. Harken recommends the 40-micron suction/return filter between the reservoir and the pump as well as an extremely fine 3-micron filter between the pump and the valves. The 40-micron filter has an anodized aluminum body with a removable, cleanable, and replaceable sintered bronze element. The high pressure 3-micron filter is made from electropolished 17-4 PH stainless or titanium. It has a replaceable paper element and can handle pressures up to 10,000 psi. -4SAE ports allow the high-pressure filter to accept any combination of fittings and adapters.

Pressure Transducers

Pressure transducers use the onboard computer to convert hydraulic pressures of up to 10,000 psi into tons or other load units. Standard lightweight versions and super lightweight Grand Prix versions are available.

Pressure Gauges

Pressure gauges, offered as an alternative to electronic transducers, can be mounted into the valve panel or plumbed remotely into a pressure line. Stainless steel 40 mm (1 1/2") cases are filled with glycerin to dampen needle movement.

Plumbing

Harken has a complete line of high-pressure and low-pressure plumbing for manual hydraulic systems. All high-pressure fittings and adapters are machined from stainless steel. Hoses can be sent to you assembled and preflushed.

Seal Kits

Seal kits are available for all valves, cylinders, and pumps. Kits include all normal wear items such as O-rings, seals, and nylon tip set screws.

Repair Kits

Repair kits are available for all valves, cylinders, and pumps. They include everything in the seal kit with the addition of select machined components that may require occasional replacement.

HAWE Tool

The HAWE tool is used for removing and reinstalling the check valves included in valve and pump repair kits.

Hydraulic Oil

Our hydraulic oil was chosen specifically for Harken high-pressure hydraulic systems. Its moisture-resistant formula features unique anti-wear additives that inhibit corrosion and provide high levels of thermal and oxidation stability to enhance lubricant performance and extend equipment life.

HYOIL22QUART: one-quart bottle.

Filters

Part No.	Description	Max pressure		End fittings		Weight	
		psi	bar	Port 1	Port 2	lb	g
HYFAP03S	High-pressure filter/stainless steel/3 micron	10000	689	-4 ORB female	-4 ORB female	.63	288
HYFAP03TF	High-pressure filter/titanium/3 micron	10000	689	-4 ORB female	-4 ORB female	.37	167
HYFAP03TM	High-pressure filter/titanium/3 micron	10000	689	-4 ORB female	-4 JIC/ORB male	.38	172
HYFAT40	Low-pressure filter/40 micron	250	17	3/8" (-6) barb	3/8" (-6) barb	.10	45
HYFAT40J6	Low-pressure filter/high-flow/40 micron	250	17	-6 JIC male	-6 JIC male	.17	75

Pressure Transducers

Part No.	Description	Max pressure		Port fitting	Output	Weight	
		psi	bar			lb	g
HYET10N2V5	Pressure transducer -2NPT	10000	689	-2 NPT	1-5 VDC	.21	95
HYET10N4V5	Pressure transducer -4NPT	10000	689	-4 NPT	1-5 VDC	.3	135
HYET1004MA20	Pressure transducer -4ORB 4-20MA	10000	689	-4 ORB	4-20 mA	.19	83
HYET604MA20	Pressure transducer -4ORB 4-20MA	6000	414	-4 ORB	4-20 mA	.2	90

Go to www.harken.com/hydraulicaccessories for more detailed information.



Filters



Pressure transducer



Pressure gauge



Plumbing



Seal kit



Repair kit



HAWE tool

HYOIL22QUART



Hydraulic Hose

Harken offers a range of hydraulic hose for high- and low-pressure oil delivery. After assembly, all high-pressure hoses are flushed clean of contaminants before shipping.

High-Pressure Hose

The HYZHP520N-3, -4, and -6 are general-purpose pressure hoses used for oil delivery to cylinders and other motor functions. They feature durable nylon tubing reinforced with high-strength aramid fiber and an abrasion-resistant polyurethane cover. Fittings sold separately. Available in cadmium-plated steel or, for greater durability, stainless steel.

The HYZHP590-3 hose is engineered for high-pressure and low-volumetric expansion, and offers precise cylinder control. The copolyester tubing is reinforced with aramid fiber and high-tensile steel wire. The cover is high-strength polyurethane for abrasion resistance. Fittings sold separately. Available in cadmium-plated steel or, for greater durability, stainless steel.

The HYZHP471TC-6 is used in power units or for power applications such as winches, furlers, and windlasses. The inner tube is synthetic rubber reinforced with two braids of steel wire. The synthetic rubber cover is abrasion resistant. Fittings sold separately. Available in cadmium-plated steel. Stainless steel available upon request.

Low-Pressure Hose

The HYZHT30R9-6 is an extremely lightweight hose used aboard race boats. The elastomer inner tube with high-strength Nomex®/Kevlar® braided cover increases abrasion resistance. The field-attachable fitting is lightweight alloy. Fitting sold separately.

The HYZHT7212-6 is a tank-line hose. The light, flexible hose is made of Nitrile rubber with braided neoprene reinforcement. Hose-barb fittings allow an easy-push connection.

For complete assemblies including hose contact Harken.



Part No.	Description	- Size	Working pressure*		Minimum bend radius		Weight	
			psi	bar	in	mm	lb/ft	kg/m
HYZHP471TC-6	3/8" High-pressure hose	-6	5000	345	2.6	65	0.56	0.84
HYZHP520N-3	3/16" High-pressure hose	-3	5000	345	1.3	38	0.05	0.07
HYZHP520N-4	1/4" High-pressure hose	-4	5000	345	2	51	0.07	0.1
HYZHP520N-6	3/8" High-pressure hose	-6	4000	276	2.5	64	0.08	0.13
HYZHP590-3	3/16" High-pressure hose	-3	5000	345	1.5	38	0.1	0.15
HYZHT30R9-6	3/8" Low-pressure hose	-6	200	14	2.5	64	0.08	0.13
HYZHT7212-6	3/8" Low-pressure hose	-6	300	21	3	76	0.12	0.18

*Typical burst pressure is 4:1.

Nomex is a registered trademark of E. I. du Pont de Nemours and Company or its affiliates.

Kevlar is a registered trademark of E. I. du Pont de Nemours and Company or its affiliates.

Through-Deck Gland

The Harken Through-Deck Gland provides a waterproof passage for hydraulic hose. Unlike other glands, Harken's model can be easily installed by one person topside. The gland's doughnut-shaped base secures over a predrilled hole in the deck with high-strength bonding tape. The urethane seal and top cap is put on the hose before attaching the swage fitting. The swage fitting passes through the deck/base, and the top cap is threaded to the base for a watertight fit.

Comes in black hardcoat-anodized 6061-T6 aluminum. Fits HYZHP520N 5 mm (3/16"), 6 mm (1/4"), and 10 mm (3/8") hose sizes.

For complete assemblies including hose contact Harken.



Part No.	Description	Gland Max Ø		Hose Ø		Height		Weight	
		in	mm	in	mm	in	mm	lb	kg
HYZD6-3	Through-Deck Gland	2.3	60	3/16	5	1	26	.2	0.11
HYZD6-4	Through-Deck Gland	2.3	60	1/4	6	1	26	.2	0.11
HYZD6-6	Through-Deck Gland	2.3	60	3/8	10	1	26	.2	0.11

Go to www.harken.com/hydraulicaccessories for more detailed information.

Choosing Hydraulic Systems

1. Cylinders

Load and Pin Sizes: Cylinder size is determined by cylinder load and pin size. Stroke length is based on cylinder function. See page 232 to select cylinder. Double-pull, locking, and boom vang cylinders are also available. See charts for loads, pin sizes, and stroke lengths.

Alternate End Fittings: Choosing the correct end fittings for your cylinders is critical. See page 234 for end-fitting options.

2. Control Valves

Select valves based on sailing style and valve style, type, and functions. Choose between multifunction panel and individual valves, Standard or Grand-Prix styles. Single or double-acting valves are based on cylinder type.

Individual Valve Assemblies: Individual valve assemblies are dependent on how the boat is sailed. Multiple control locations? Single control locations? Choose valve, manifold configurations, and panel types. See page 243.

Multifunction Valve Panels and Single-function Panels: Choose plate materials. Single and multifunction panels come with a 2-speed pump, pump handle, and reservoir. See page 244.

Remote Dump Valves: Are remote dump valves required? Example: vang cylinders.

3. Pumps & Handles

Individual valves require a separate pump. How many? 2-speed or 3-speed? Choice depends on oil volume, how fast oil must move, and pressure required. Select adequate handle. See pages 245-246.

4. Reservoirs

Reservoir Type: Reservoir type is determined by the amount of oil needed and pump height relative to the reservoir. Use a pressurized reservoir if it is mounted more than 1.5 m (5') vertically below the pump. Vented reservoirs are adequate under 1.5 m (5').

Reservoir Size: As a general rule, select reservoir size by adding up cylinder volumes and multiplying by 2.

5. Accessories

Filters: Harken highly recommends a high-pressure filter between the pump and valves to keep valves working at peak performance. Also recommended: a suction filter for the pump to prevent debris from entering the system.

Gauges: Remote analog gauges and digital transducers available.

Fittings: Plumbing fittings, additional spares, blanking plates, and spare parts available. See page 249-250.

Standard System

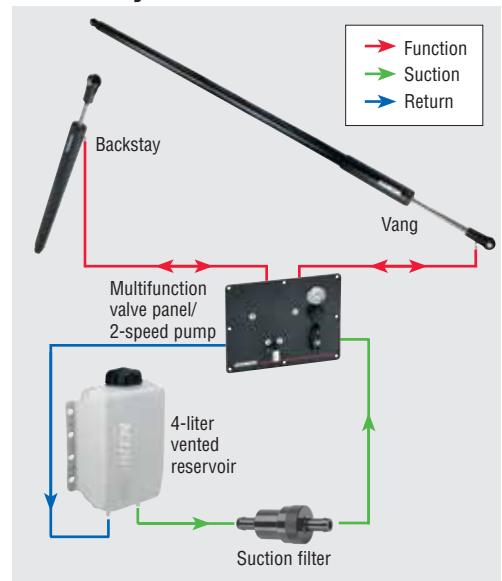

Grand Prix System

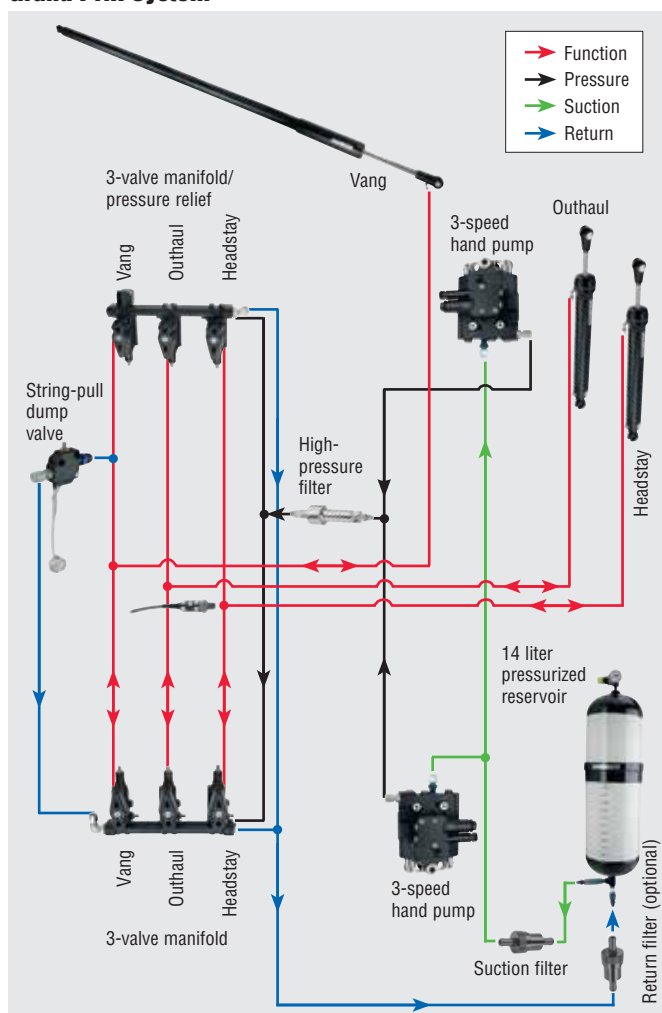



© Ingrid Aberly

DC HYDRAULIC POWER SYSTEMS

When designing a powered system, we first gather information on the number of functions as well as flow and pressure requirements for each. Every powered system is different. Harken is committed to providing systems designed specifically to account for flow, pressure and other performance requirements of each project. We also talk to the client about how the boat will be used to assure the system will perform as expected.

Harken DC hydraulic systems power functions including cylinders, vang, lifting keels, winches, furlers, windlasses, and small bow thrusters. The system is comprised of three main components:

- **The power unit** includes motors and pumps to deliver oil. We offer a variety of options for different flow and pressure needs. All power units include return filtration, motor temperature sensors, and tank level sensors.
- **Valves** direct and deliver oil to hydraulic functions. Our family of modular cartridge manifold valves stack together for an extremely flexible system. These zero-leak valves have flow and pressure controls as well as pressure-relief.
- **The electrical control box** is the brain of the system. On-deck push-button controls turn valves and pumps on/off. Our latest control boxes all include a small PLC controller to map inputs to outputs. Boxes come pre-wired. Simply plug M12 cables to connectors on the outside of the box.

We provide hands-on service for all Harken hydraulic power systems, and we look forward to serving our customers beyond their expectations.

Please contact us with any of your hydraulic powered system needs. We will be happy to provide detailed specifications and quotation.

High-flow, low-pressure power units are ideal for powering winches, furlers, small windlasses, and thrusters.

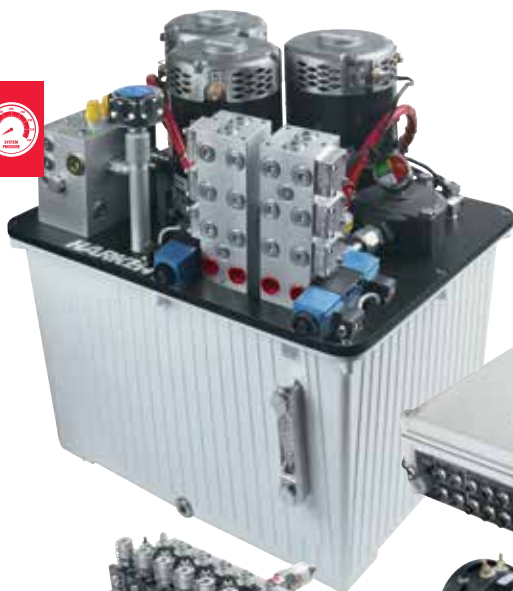

Modular cartridge manifold valves.



High-pressure, low-flow compact power units are perfect for powering cylinder functions.

DO NOT use Harken equipment for human suspension unless product is specifically certified and labeled for such use.



Kim Deede **Customer Account Specialist**

Harkenite Since 2013

Kim Deede
has worked
in Customer Service

in Pewaukee for 6 years – processing orders for Harken’s domestic and international customers, and then making sure the orders ship properly.

One of those customers is Captain Greg Fordon of the *Volvo 70 II Mostro*, which recently completed an elapsed time record between Chicago and Mackinac Island in 17 hours, 59 minutes and 49 seconds.

“He made me feel pretty cool that I was helping him,” Kim said. “I love seeing my customers do amazing things, and being part of it!”

Kim likes working at Harken. “We can wear jeans and shorts in the summer,” she says. “And, we have our annual Harken Sail Day on Lake Michigan.”

When she’s not at the office, Kim enjoys yoga, biking, reading, hiking, and cooking for her family.



Fast that Lasts



ML8



7881



7880



7875

SAILKOTE™

FOR EVERYTHING THAT SLIDES

High Performance Dry Lubricant*

Use on hatches, drawers, sliding doors, sail tracks, mast tracks and slides, fishing reel components and fly line, sails, battens and telltales, slider cars and tracks

- Repels water, dirt, salt and contaminants
- Reduces drag in air and water
- Clean, dry, and easy to use
- Lasts up to 10 times longer than additives, oil, or wax-based lubricants

* Available at US and international dealers

HULLKOTE™

FOR EVERYTHING THAT SHINES

High Performance Speed Polish

Use on fiberglass, metal, plexiglass, and painted surfaces

- Cleans, polishes, and protects
- Reduces drag and repels water
- Environmentally friendly citrus base
- Long-lasting, high-gloss finish
- Superior UV protection

ANTIFOUL ALTERNATIVE

FOR EVERYTHING BELOW THE WATERLINE

Environmentally Friendly Antifoul Polish

Use on hulls, outdrives, and propellers

- Helps prevent below-the-waterline marine growth and slime from adhering for weeks
- Reduces drag and increases efficiency
- Biodegradable, non-metallic, non-leaching

ONEDROP™

FOR EVERYTHING THAT ROLLS

Ball Bearing Conditioner

Use on ball bearing traveler cars and battcars

- Repels salt, dirt, and other deposits
- Protects, lubricates, and conditions bearing surfaces
- Reduces friction so balls roll freely and evenly, greatly improving performance
- Only one drop needed

Team
McLube®
www.mclubemarine.com

Worldwide Limited Warranty

COVERAGE. HARKEN warrants that each HARKEN product, when properly used and maintained, will be free from defects in material and workmanship from the date of receipt of the product by the final customer. HARKEN products are covered by two different kinds of warranties, on the basis of the purchaser and use made of them.

1. The Private Customer Warranty

2. The Professional Customer Warranty

THE LIMITED PRIVATE CUSTOMER WARRANTY. This limited warranty applies to all Harken products purchased for final use by private individuals only and installed on boats used exclusively for recreational purposes. Harken products installed on boats used for any other purpose or by any other entity are covered by the limited PROFESSIONAL CUSTOMER WARRANTY. The Owner's sole and exclusive remedy under this limited PRIVATE CUSTOMER WARRANTY for original defects in materials or workmanship of a HARKEN product shall be the repair or replacement, in HARKEN's sole discretion, of the defective part or component, at no charge to the owner of the product.

THE LIMITED PROFESSIONAL CUSTOMER WARRANTY. This limited warranty applies to all Harken products purchased for final use by or on behalf of any entity other than a private individual (such as by corporations, partnerships, competitive race groups, etc.) or installed on boats used for any purpose other than recreational use, such as for hire, charter or other professional or commercial events or activities. Such Professional Customers may include, but are not limited to, America's Cup Syndicates, international competitive syndicates, racers in transoceanic and globe-circling events, one-design racers with boats 40 feet and up racing in major competitive and international competition.

The Owner's sole and exclusive remedy under this limited PROFESSIONAL CUSTOMER WARRANTY for original defects in materials or workmanship of a HARKEN product shall be the repair or replacement, in HARKEN's sole discretion, of the defective part or component, in accordance with the terms of this warranty.

WARRANTOR. For products originally sold in the United States, the limited warranty for the products is supplied by HARKEN, INC.. For products originally sold in the European Union, the limited warranty for the products is supplied by the dealer who sold the product through the Harken Distributors in that country. For products originally sold in the rest of the World, the limited warranty for the products is supplied directly by the Harken Distributors in that country. When "HARKEN" is mentioned throughout this Limited Warranty, it refers to the entity as defined in this paragraph.

OWNER – NON-TRANSFERABLE WARRANTY. This warranty is made by HARKEN with only the original purchaser of the product and does not extend to any third parties. The rights of the original purchaser under this warranty may not be assigned or otherwise transferred to any third party.

WARRANTY TERM. The limited PRIVATE CUSTOMER WARRANTY covers any original defects in material or workmanship manifested within five (5) years of the date of receipt of the product by the final customer.

However, the warranty terms under the limited PRIVATE CUSTOMER WARRANTY for the following products are as indicated below by the date of receipt of the product by the final customer:

1. **Jib Reefing and Furling systems** are warranted for seven (7) years. Hydraulic and Electric Furling systems are warranted for five (5) years. Electric furling motor, switches, control boxes, and breakers are warranted for two (2) years.
2. **Reflex furler for asymmetric and code zero sails, associated adapters, cable terminals/clamps, and fairlead kits,** are warranted for three (3) years. **Reflex torsion cable** is warranted for one (1) year.
3. **Carbo Racing Foils** are warranted for three (3) years.
4. **Winches and handles, cylinders, valves, pumps, reservoirs, control panels** are warranted for three (3) years. **Electric/hydraulic winch motors, captive reel winches, CLR mooring winches, hydraulic power units, switches, control boxes, and breakers** are warranted for two (2) years.
5. **Custom products, pedestals, gearboxes, push buttons, drive shafts, carbon fiber products, and/or high performance applications** of standard catalog products for extraordinary use applications are warranted for two (2) years.
6. **Harken gloves, sunglasses, and related accessories** are warranted for two (2) years from date of purchase. Warranty excludes normal wear and tear.
7. **Ropeye® products:** contact Ropeye.com for warranty terms.

The limited PROFESSIONAL CUSTOMER WARRANTY covers any original defects in material or workmanship manifested within 12 months of the date of receipt of the product by the final customer.

NOT COVERED. Neither the limited PRIVATE CUSTOMER WARRANTY nor the limited PROFESSIONAL CUSTOMER WARRANTY applies to, nor shall HARKEN

have any liability or responsibility for, damages or expenses relating to defects caused by misuse, abuse, failure to install, use, maintain, or store the HARKEN product as specified in the warranty booklet, service booklet, manuals, catalogue, or other literature available from HARKEN.

Neither the limited PRIVATE CUSTOMER WARRANTY nor the limited PROFESSIONAL CUSTOMER WARRANTY applies to, and neither HARKEN shall have any liability or responsibility in respect of, damages or expenses relating to:

- defects in material or workmanship that did not exist when the product was first delivered;
 - defects in material or workmanship that are manifested outside the warranty period;
 - defects which are not reported to HARKEN within sixty (60) days of discovery;
 - a product that has been altered or modified from factory specifications;
 - damage or deterioration of cosmetic surface finishes, including cracking, crazing, discoloration, or fading;
 - accidents, misuse, abuse, abnormal use, improper use, lack of reasonable or proper maintenance or storage;
 - installation, wiring, service, or repairs improperly performed or replacement parts or accessories not conforming to HARKEN's specifications;
 - use exceeding the recommended and permitted limits or loads of the product and/or the vessel on which the product is installed;
 - normal wear or deterioration occasioned by the use of the product or its exposure to the elements;
 - besides HARKEN's Hoister products used to store watercraft and bicycles, any use outside, other than or besides normal sailing or sailboat applications;
 - ropes, lines, LOUP® soft attachments, buckles, and webbing;
 - clear coat finishes on carbon fiber;
 - loss of time, loss of use, inconvenience, travel expense, costs related to procuring any substitute boat, transportation costs, towing costs, any incidental or consequential damages arising out of the non-use of the boat, or compensation for inconvenience or loss of use while the boat is being repaired or otherwise not available, or other matters not specifically covered hereunder;
 - the costs to remove, disassemble, or re-install the product;
 - the costs or expenses associated with transporting the product to and from HARKEN or a HARKEN dealer
 - hauling out, storage, and relaunching of the boat on which the product has been installed, even where this is necessary to carry out the warranty service.
- The limited PROFESSIONAL CUSTOMER WARRANTY does not cover, nor shall HARKEN have any liability or responsibility in respect of, damages or expenses relating to, the following products and/or components:
- pawls and pawl springs in winches;
 - components and gears in titanium;
 - washers and spacers;
 - winch drum grip;
 - ball bearings, roller bearings, thrust bearings;
 - winch handles.

PROCEDURE. In the event of a defect covered by this limited warranty, the Owner shall contact one of HARKEN's worldwide Distributors (there is a list of them on the www.harken.com site). If the product was originally sold in European Union the Owner shall contact the dealer that sold the product. To obtain warranty service for or replacement of your HARKEN product, your specific and detailed claim must be reported to and received by HARKEN, in writing, in accordance with the terms of this warranty and within the applicable warranty period. Also provide your name, address, phone number, original sales receipt, a description of the application of the product, and an explanation of the defect and conditions under which the product was used. If the examination of the product and the warranty claim reveals that the defect is not covered by this warranty, you will be contacted and advised of the cost of repair of your product. If you accept this estimate, the product will be repaired outside of this warranty.

DAMAGES OR OTHER COSTS. Except as expressly provided by this warranty, **HARKEN SHALL NOT BE RESPONSIBLE FOR ANY INCIDENTAL OR CONSEQUENTIAL DAMAGES OR OTHER COSTS, WHETHER THE CLAIM IS BASED IN CONTRACT, TORT, OR OTHERWISE, including but not limited to any costs, taxes, fees, levies, or other expenses imposed by any location in which the product was originally sold.** The foregoing statements of warranty are exclusive and in lieu of all other remedies. Some jurisdictions do not allow the exclusion or limitation of incidental or consequential damages, so this limitation or exclusion may not apply to you.

Ropeye is a registered trademark of Ropeye OÜ.
Loup is a registered trademark of Yale Cordage.



Worldwide Limited Warranty

DISCLAIMER. ANY IMPLIED WARRANTY OF MERCHANTABILITY OR FITNESS FOR A PARTICULAR PURPOSE AND ALL IMPLIED WARRANTIES ARISING FROM A COURSE OF DEALING, USAGE OF TRADE, BY STATUTE OR OTHERWISE, IS HEREBY STRICTLY LIMITED TO THE TERM OF THIS WRITTEN LIMITED WARRANTY. This Agreement shall be the sole and exclusive remedy available to the Owner with respect to this product. In the event of any alleged breach of any warranty or any legal action brought by the purchaser based on alleged negligence or other tortious conduct by HARKEN, the Owner's sole and exclusive remedy will be repair or replacement of defective materials as stated above. No dealer and no other agent of HARKEN is authorized to modify, extend, or enlarge this warranty.

APPLICABLE LAW. This warranty is governed by the laws of the State of Wisconsin for all products originally sold outside European Union. This warranty is governed by the laws of the Member State of the European Union where the product was originally sold. The exclusive jurisdiction and venue for any court action commenced by you under or relating to this limited warranty or any implied warranty(ies) shall be decided in the Courts of Waukesha County, Wisconsin or in the competent European Union State Member Court if the product was originally sold in European Union.

In the event HARKEN prevails in any court action, the claimant shall reimburse HARKEN for the expenses, including attorney fees and expenses of litigation, reasonably incurred by HARKEN in defending against such claim.

OTHER RIGHTS. Claimant's acceptance of delivery of the warranted HARKEN product constitutes acceptance of the terms of this limited warranty. This warranty gives specific legal rights, and claimant may also have other rights under the laws of the jurisdiction involved.

ENTIRE AGREEMENT. This document contains the entire warranty given by HARKEN in respect of your product and supersedes any and all oral or express warranties, statements, or undertakings that may previously have been made. Any and all warranties not contained in this warranty are specifically excluded. There are no terms, promises, conditions, or warranties regarding your product other than those contained herein. HARKEN specifically does not authorize any person to extend the time or scope of this warranty or to create or assume for HARKEN any other obligation or liability with respect to HARKEN products.

June 2008/112616.1

General Warnings and Instructions

Sailing is an exciting sport that can provide hours of enjoyment for you, your family, and friends. However, there are risks inherent in the sport, as well as with the equipment involved, that must be respected in order to avoid an accident, damage to your vessel, personal injury, or death.

WARNINGS AND INSTRUCTIONS. You must carefully read, understand, and follow all of the warnings and instructions provided by Harken in order to avoid an accident. These warnings and instructions can be found on the equipment, in its packaging, in our brochures, on our website, or through our customer service department.

HYDRAULIC EQUIPMENT WARNING. Pressurized hydraulic cylinders can be dangerous and if handled improperly may explode, possibly causing an accident, damage to your vessel, personal injury or death. Cylinders should only be serviced by a thoroughly trained and equipped hydraulic technician following the instructions in the manual.

TRAINING AND EXPERIENCE. Even though Harken equipment appears simple and easy to operate (as intended by our design), our equipment should never be used unless you have a sufficient level of training and experience in sailing in general and with the equipment in particular. The amount of training and experience depends on a number of factors, including the size and type of your vessel, the weather conditions, and the task you are trying to complete. If you have any doubt whatsoever about your training or experience, please do not use the equipment. Please contact Harken or seek additional training.

AVOID ACCIDENT & INJURY. Regardless of your skill level, in order to avoid an accident, damage to your vessel, personal injury, or death:

1. Loads on hardware can be significant, and shock loading from heavy winds or seas can quickly multiply that load to extremely high levels. Maximum line diameter is a guide to sheave groove size and not intended to provide the maximum working load of the block. All persons selecting, installing, or maintaining Harken gear must be aware and cautious of such loads.

Select appropriate Harken hardware by using the loading formulas and charts provided in the Harken catalog or online at www.harken.com. Always confirm your selection with a rigging professional or contact Harken directly.

2. Never, under any circumstances, exceed the capacity or **Maximum Working Load (MWL)** of any piece of equipment. The maximum working load may be found in our catalog, on our website, or through our technical service department. Loads above the MWL can cause the equipment to fail suddenly and unexpectedly.

The Breaking Load (BL) is the load at which a product is likely to fail. It is much higher than the highest load a product should ever experience, and should not, under any circumstances, ever be considered in selecting equipment. It is published for informational purposes only.

3. Harken hardware and winches shown in the Harken catalog and the harken.com website are designed and engineered for use on sailing boats for normal sailboat applications for rigging. **Do not use Harken equipment for human suspension unless product is specifically certified and labeled for such use.** Aloft rigging and maintenance must be left to rigging professionals only. For non-sailing applications consult the HarkenIndustrial.com website and consult with experts at Harken regarding product certification prior to using for human suspension.

4. Keep fingers, hands, hair, loose clothing, gloves, and tools away from moving parts.

5. If you are securing any equipment to the vessel with screws or other fasteners, be sure you are installing the screw into solid structure, or that you use anchor bolts, and that the attachment is sufficient to hold the anticipated load. Otherwise, the screw could become loose over time, or otherwise fail unexpectedly, resulting in an accident.

6. NYLOK® nuts must not be used after being removed three times. When you replace shackles and fasteners, use the correct Harken parts to maintain the proper strength.

7. Always have all components of your vessel, down to the smallest pulleys, inspected for wear, corrosion, or deterioration at least yearly, and replace as necessary.

8. Before manipulating any piece of equipment, be sure that all persons and objects are clear of the path of movement of all reacting components.

9. As part of your maintenance procedures and to keep your equipment in optimum working order, frequently flush it with fresh water.

10. Always wear a personal flotation device and/or harness while on board any vessel, and especially while manipulating equipment.

11. Always be sure all safety equipment and electronics are in good working order before you set out on your journey.

12. For general boating safety information, visit the maritime organization in your sailing destination country (such as the United States Coast Guard at www.uscgboating.org).

Nylok is a registered trademark of Nylok Corporation.

Harken Trademarks

Following is a non-exhaustive list of Harken, Inc. trademarks and registered trademarks in the U.S. and other countries and the corresponding product.

The list is updated from time to time. The absence of a trademark or associated product from this list does not constitute a waiver of Harken, Inc. trademark or other intellectual property right concerning that word or logo.

Registered Trademarks

Registered Trademarks	Product
Air®	block, runner block, foil, sheave, winch
Black Magic®	block, Air® block, glove
Cam-Matic®	cleat
Carbo®	block, racing foil, ratchet block, Ratchamatic® block, fiddle block
Carbo-Cam®	cleat
Harken®	blocks, ratchet blocks, sheaves, cleats, fairleads, shackles, padeyes, mainsheet and genoa lead traveler cars and track, batten cars and track, furling systems, foils for raising and lowering racing sails, winches, hydraulic systems including hydraulic cylinders, valves, lines, manifolds, transmissions, and pumps; manual hoists; rope ascenders and descenders; elevating rope work platforms and life-saving safety mechanisms; covers for boats and equipment; duffel bags, sport bags; gloves, shirts, headwear; after-sun lotions, lip balms, sunscreen preparations
Hexaratchet®	block, sheave
PowerSeat®	ascender
Radial Line®	winch
Ratchamatic®	block

Trademarks

Trademarks	Product
Bullet™	block
Crossbow™	pivoting self-tacking jib traveler, traveler
Element™	block, shackle block
FlatWinder™	block, powered block
Fly™	block, soft-attach block
Performa™	winch
Protexit™	block, through-deck block
Reflex™	furling, top-down furling
Rewind™	winch, Radial Line® winch
T2™	soft-attach block, block, loop block
UniPower™	winch, Radial Line® winch
V™	block, soft-attach block





Maintenance

Harken equipment is designed for minimal maintenance. However, some upkeep is required to give the best service and comply with the Harken limited warranty. Harken installation manuals are available at no charge online at www.harken.com or by contacting a Harken dealer.

Always flush frequently with fresh water and periodically inspect all products for damage. Do not let deck hardware come in contact with teak cleaner or other caustic solutions as this causes discoloration and damage to the finish.

Product	General Information	Inspection	Cleaning	Lubrication	Fasteners
Small Boat and Midrange Blocks	Tape cotter rings to prevent snagging. Do not leave heavy loads on blocks when not in use as this may slightly deform the bearings. Normally bearings will return to their proper shape after rotation, but an initial resistance to rolling may be felt.	1	4 5		11
Big Boat Blocks	Big Boat bearings are resistant to deformation, but we recommend releasing heavy loads on any hardware when not in use.	1	4 Black Magic Air blocks disassembled, solution on rollers		12
Cams			4 Apply to bearings		11 On cam screws
Travelers and Battcars		1	4 Apply to bearings	7 On balls 8 Slider cars only	11 On bolts 13
Furling	Refer to the owner's manual for detailed maintenance instructions.	2	4 Apply to bearings		11 On Cruising foil clamp screws 14 On foil screws MKIV and ESP
Winches	Refer to the owner's manual for detailed maintenance instructions. Over application of grease can cause salt and water deposits to become trapped in the winch. Clear drain ports of sealants or grease. Lubricate pawls with Harken Pawl Oil. Do not grease pawls.	3	4 Plastic parts 4 Winch top 6 Metal parts	9 On gears 10 On pawl	12 On socket bolt 13

- 1** **Inspect frequently:** shackles and shackle posts for signs of corrosion, cracks, or elongation.
- 2** **Inspect:** lashings and loops for UV damage, wear, or chafe. When replacing loops, lashings, or shackles, use Harken parts to maintain the proper strength.
- 3** **Inspect frequently:** wire terminals, turnbuckle components, toggles, shackles, clevis and cotter pins below and inside drum assembly for signs of loosening, corrosion, or cracks.
- 4** **Check for wear and corrosion:** Check pawls and springs, bearings, gears, and spindles.
- 5** **Clean:** Keep your equipment clean and free-running by frequently flushing with fresh water. Periodically clean with mild detergent and water solution. Spin sheaves, rotate cams, and roll cars back and forth to distribute soap solution evenly.
- 6** **Clean:** with Scotch Brite® pad on Classic block sideplate and stainless steel strap.
- 7** **Degrease:** Remove grease with degreaser. Harken recommends environmentally friendly citrus degreasers.
- 8** **Condition:** Use only a single drop of McLube OneDrop™ ball bearing conditioner. Too much oil attracts dirt.
- 9** **Lubricate:** Dry lubricants such as McLube® Sailkote, dry PTFE, and dry silicon sprays which will not attract dirt may be used on slider cars.
- 10** **Grease lightly:** with Harken winch grease.
- 11** **Lubricate:** winch pawls with a drop of Harken Pawl Oil. Do not grease winch pawls.
- 12** **Adhesive:** Blue Loctite®. Temporary adhesive. Can be removed without heating.
- 13** **Anti-seize:** Coat stainless fasteners that pass through aluminum blocks with an anti-seize compound such as Tef-Gel®.
- 14** **Replace:** lock nuts after the third removal.
- 15** **Adhesive:** Red Loctite®. Semi-permanent adhesive. Can be removed with heat. Electric heat gun will not raise temperature enough to break adhesive seal.

McLube is a registered trademark of McGee Industries, Inc. Loctite is a registered trademark of Henkel AG & Company KGaA. Scotch Brite is a registered trademark of 3M Company. Tef-Gel is a registered trademark of Ultra Safety Systems, Inc.

Genoa Lead Cars

Part numbers represent hardware most commonly used.

Typical boat length:

Small Boat: 6.7 - 8.5 m (22 - 28')

Midrange: 8.8 - 10.4 m (29 - 34')

Big Boat: 10.7 - 12.8 m (35 - 42')

Diagram Ref.	Description	Small Boat Part No.	Midrange Part No.	Big Boat Part No.
Pinstop Slider				
A	Lead car	G226S	G276S	G326S
B	Cheek	6237	6267	6294
C	Track	2751	R27	R32

Diagram Ref.	Description	Small Boat Part No.	Midrange Part No.	Big Boat Part No.
Multi-Track				
A	Lead car	G226S	G276S	G326S
B	Track	2751	R27	R32
C	Lead car	G222B	G273B	G323B
D	End control	2740	E2750	E3250
E	Track	2720	R27	R32
F	Footblock	6267	3220	3234
G	Endstop	E2200	E2700	E3200
H	Cheek	350	2644	6106
I	Cam cleat	365	150	280

Diagram Ref.	Description	Small Boat Part No.	Midrange Part No.	Big Boat Part No.
Barbahauler				
A	Lead car	G2227B	G2737B	G3247B
B	End control	2740	1632	3169
C	Track	2720	R27	R32
D	Endstop	E2200	E2700	E3200
E	Cheek	350	2644	6237
F	Cam cleat	365	150	150

Beachcat Jib Controls		2.4 - 4.3 m (8 - 14')	4.6 - 6.4 m (15 - 21')	—
A	Single	348	2636	—
B	Single	2611	2628	—
C	Cheek	350	2644	—
D	Cam cleat	468	150	—

Crossbow		2758.1.1M.50	—	—
A	Crossbow	2758.1.1M.50	—	—
B	Single	2149	—	—
C	Single	404	—	—
D	Cheek	416	—	—
E	Single	2698	—	—
F	Cam Base	240	—	—

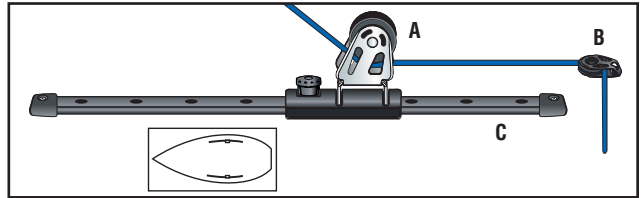

Pinstop Slider: A pinstop slider car on ball bearing track is recommended for cruising boats that might upgrade to adjustable ball bearing cars.

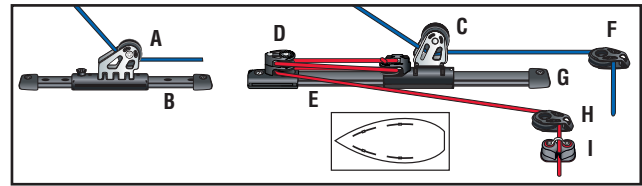

Multi-Track: Use an adjustable car for the #1 and #2 genoas. Use a pinstop car for the #3 and #4 jibs. Adjust the forward car with a pinstop slider.

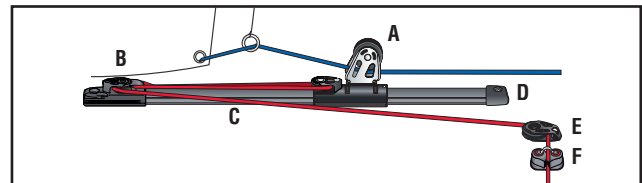

Barbahauler: Use this low-profile system on racing boats with nonoverlapping jibs like the Farr® 40 and One Design 35. An inhaul is used to control slot size.

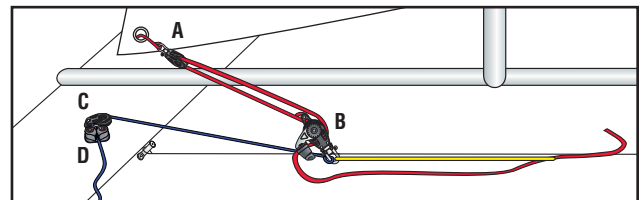

Beachcat Jib Controls: This jib traveler is used to haul the jib sheet block outboard for slot adjustment on multihulls up to 6.4 m (21').

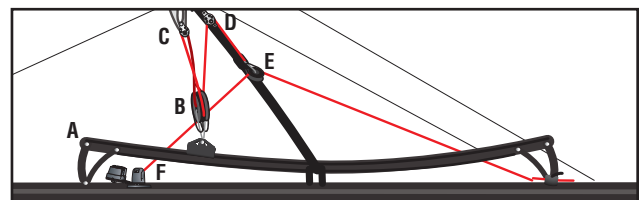

Crossbow: The Crossbow is a self-tacking jib system designed for high-performance dinghies, skiffs, and catamarans under 6 m (20').

Traveler

Part numbers represent hardware most commonly used.

Standard boat length*:

Small Boat: 6.7 - 8.5 m (22 - 28')

Midrange: 8.8 - 10.4 m (29 - 34')

Big Boat: 10.7 - 12.8 m (35 - 42')

*Refer to **Ordering Mainsail Travelers** for in-depth specifications by boat type.

Diagram Ref.	Description	Small Boat Part No.	Midrange Part No.	Big Boat Part No.
2:1 Cam on Car				
A	Traveler	2734	—	—
B	Track	2720	—	—
C	Eyestraps	073	—	—
3:1 Windward Sheeting				
A	Traveler	2745	1635	—
		2746	1636	—
B	End control	2740	1631	—
C	Track	2720	R27	—
4:1 Windward Sheeting				
A	Traveler	—	1635	3177
B	End control	—	1631	3168
C	Track	—	R27	R32
2:1 Remote Cleat				
A	Traveler	2728	—	—
B	Eyestraps	137	—	—
C	Track	2720	—	—
D	Cam cleat	150	—	—
Standard 3:1				
A	Traveler	2731	T2731B	T3231B
B	Control block	348	—	—
C	End control	2743	E2756	E3256
D	Track	2720	R27	R32
Standard 4:1				
A	Traveler	2727	T2742B	T3242B
B	Control block	342	—	—
C	End control	2743	E2756	E3256
D	Track	2720	R27	R32
2:1 with Dedicated Winch				
A	Traveler	—	—	T3222B.HL
B	End control	—	—	E3230.HL
C	Winch	—	—	46.2STA
D	Track	—	—	R32

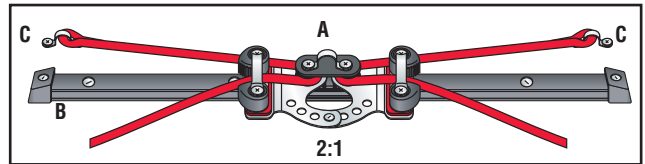

2:1 Cam on Car: This system features cleats on adjustable arms that can be angled. On flush-deck boats, face cleats the length of the track. On boats with seat backs, angle the cleats forward or aft.

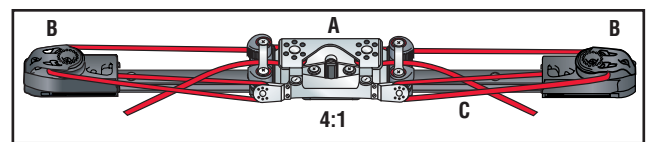
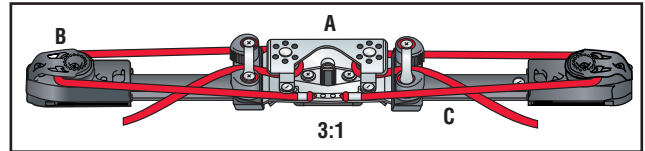

Windward Sheeting: The windward sheeting traveler lets crew pull the car about the centerline without releasing the leeward control line. Tack and the car stays in the same position, ready to be pulled to the new windward side.

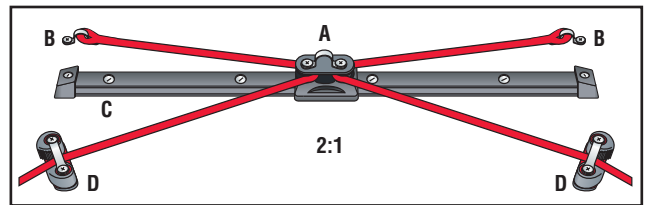

2:1 Remote Cleat: Use this 2:1 system on flush-deck boats like the J/24 where crew sit outboard of the traveler and loads are nearly vertical.

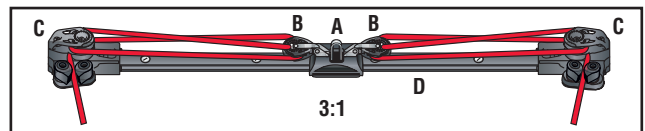

Standard 3:1: This system, with cleats on the track, is used on boats under 10.7 m (35').

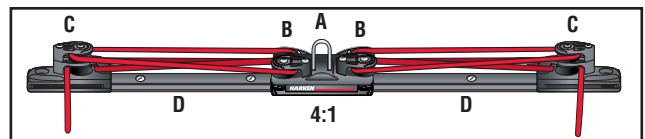

Standard 4:1: This 4:1 system is used on moderately-sized cruising and racing boats. Control blocks and cleats mount on track ends.

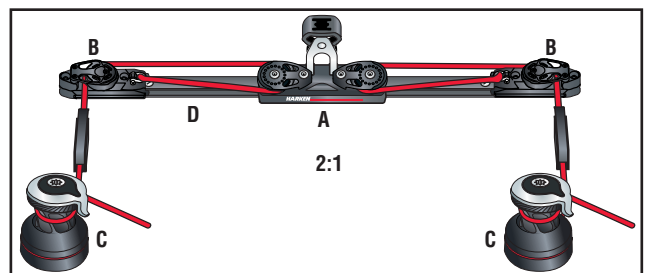

2:1 with Dedicated Winch: Install this system on big boats when winches are used to adjust the traveler.

Traveler

Part numbers represent hardware most commonly used.

Standard boat length*:

Small Boat: 6.7 - 8.5 m (22 - 28')

Midrange: 8.8 - 10.4 m (29 - 34')

Big Boat: 10.7 - 12.8 m (35 - 42')

*Refer to **Ordering Mainsail Travelers** for in-depth specifications by boat type.

Diagram Ref.	Description	Small Boat Part No.	Midrange Part No.	Big Boat Part No.
4:1 Remote Cleat				
A	Traveler	2727	T2742B	T3242B
B	Control block	342	—	—
C	End control	2742	E2750	E3250
D	Track	2720	R27	R32
E	Cam cleat	150	150	150
		—	365	—
3:1 Remote Cleat				
A	Traveler	2727	T2703B	T3203B
B	Control block	341	2637	2601
C	Upright block	220	220	223
D	Cam cleat	150	150	150
		—	365	—
E	Track	2720	R27	R32
Underdeck Traveler Control				
A	Traveler	—	—	T3203B.HL
B	Track	—	—	R32
C	Single	—	—	3215
D	Triple	—	—	2605
E	Triple	—	—	2604
F	Upright block	—	—	222
G	Cam cleat	—	—	150
H	Padeye	—	—	627
4:1 Dodger Block				
A	Traveler	—	—	T3242B
B	End control	—	—	E3250HB
C	Track	—	—	R32HB
D	Track riser	—	—	1849
E	Halyard lead block	—	—	1986
F	Cam cleat	—	—	458

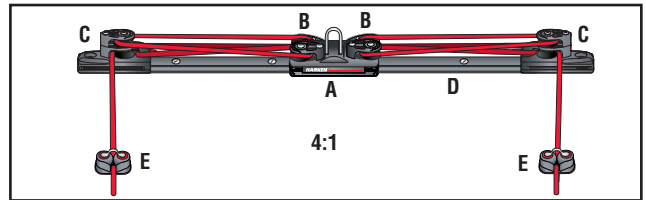

4:1 Remote Cleat: If the traveler is mounted ahead of the companionway, place the cleats at the aft-edge of the cabin house.

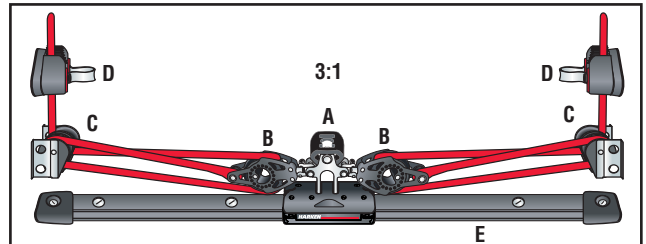

3:1 Remote Cleat: When the crew sits above the traveler, lead control lines up the cockpit sides to a convenient cleat on the coaming.

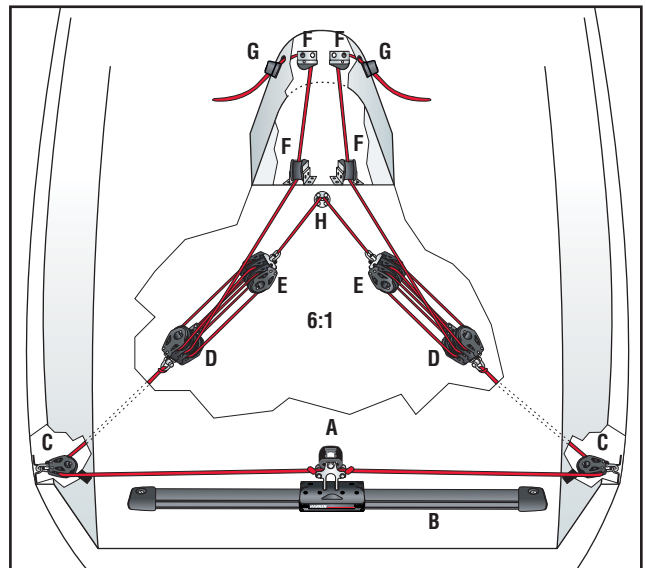

Underdeck Traveler Control: Racing boats often keep decks clean by running the traveler tackle belowdeck. This system has a 6:1 purchase that exits at a central control pod forward of the wheel or tiller, which allows the mainsheet trimmer to easily adjust the traveler. Popular on boats like the Farr® 40.

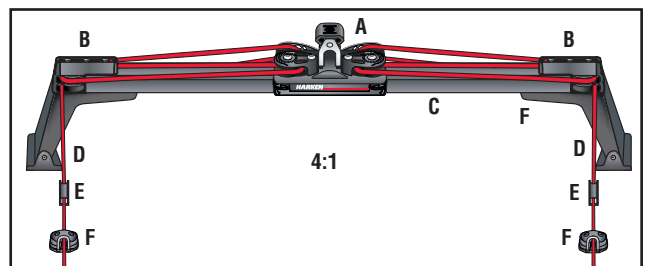

4:1 Dodger: This system works well with a dodger.

Mainsheet

Part numbers represent hardware most commonly used.

Typical boat length:

Small Boat: 6.7 - 8.5 m (22 - 28')

Midrange: 8.8 - 10.4 m (29 - 34')

Big Boat: 10.7 - 12.8 m (35 - 42')

Diagram Ref.	Description	Small Boat Part No.	Midrange Part No.	Big Boat Part No.
--------------	-------------	---------------------	-------------------	-------------------

4:1 Fiddle

A	Fiddle	2621	2690	1559
B	Fiddle	2676	2697	1566

6:1 Reeved Right Angle

A	Triple	2604	2664	1546
B	Triple	2141	2686	1556

8:1 Beachcat

	Multihulls	2.4 - 4.3 m (8 - 14')	4.6 - 6 m (15 - 20')	6.4 - 9 m (21 - 30')
A	Quad	2654	2631	2677
B	Triple	2619	2632	2687

4:1 Swivel Base

A	Single	2600	2660	1540
B	Single	2601	2661	1541
C	Single	2135	2670	1549
D	Cam base	205	144	1574

4:1/16:1 Gross/Fine

A	Single	2636	2600	2660
B	Double	381	2642	2602
C	Fiddle	2658	2676	2697
D	Fiddle	2675	2696	1565

4:1/16:1 Double-ended Fine Tune

A	Single	2636	2600	2660
B	Single	2135	2135	1549
C	Cam base	205	144	1574
D	Double	342	2638	2602
E	Single	349	2652	2600
F	Cam cleat	471	471	150

6:1/24:1 Gross/Fine

A	Double	2638	2602	2662
B	Triple	2647	2629	1555
C	Single	2636	2600	2660
D	Fiddle	2655	2621	2690
E	Fiddle	2676	2676	2697

6:1/24:1 Cascaded

A	Triple	2640	2604	2664
B	Triple	2617	2629	2685
C	Double	2638	2638	2602
D	Fiddle	2658	2658	2676

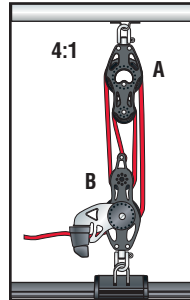

4:1 Fiddle: This 4:1 tackle is the most common system on boats under 8.5 m (28').

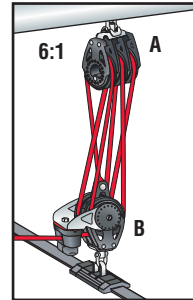

6:1 Reeved Right Angle: Boats with mainsails to 35 m² (375 ft²) often use a 6:1 system.

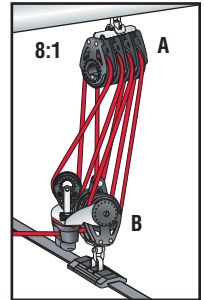

8:1 Beachcat: This 8:1 purchase handles high mainsheet loads on Beachcats up to 6 m (20').

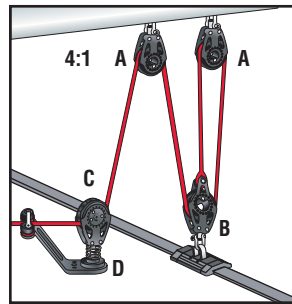

4:1 Swivel Base: Position the swivel base block off the traveler car to allow mainsail adjustment without dragging the car to windward in light air. To avoid tightening the leech, curve the track ends up.

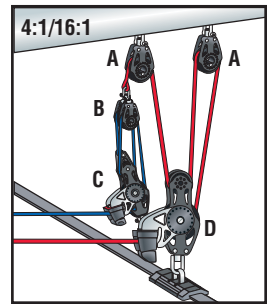

4:1/16:1 Gross/Fine: This powerful gross-trim/fine-tune cascading system allows crew to use the 4:1 gross-trim for most trimming and the 16:1 fine-tune for precise adjustments.

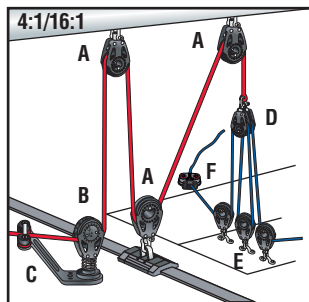

4:1/16:1 Double-ended Fine Tune: This 4:1/16:1 system uses a dinghy-like double-ended tackle that locates the sheet ends on the cockpit sides.

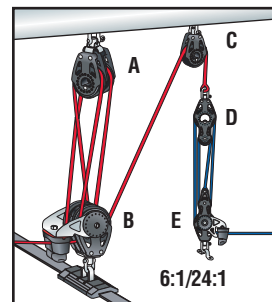

6:1/24:1 Gross/Fine: This 6:1/24:1 cascading system is used on boats with end-boom sheeting and mains as large as 25.5 m² (275 ft²) and end-boom sheeting.

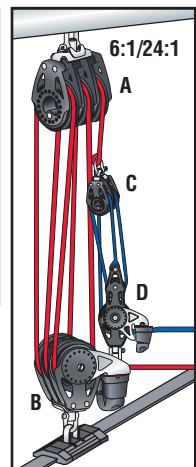

6:1/24:1 Cascaded: This 6:1/24:1 system is used on boats with mains as large as 25.5 m² (275 ft²) and end-boom sheeting.

Mainsheet

Part numbers represent hardware most commonly used.

Typical boat length:

Small Boat: 6.7 - 8.5 m (22 - 28')

Midrange: 8.8 - 10.4 m (29 - 34')

Big Boat: 10.7 - 12.8 m (35 - 42')

Diagram Ref.	Description	Small Boat Part No.	Midrange Part No.	Big Boat Part No.
7:1/28:1 Gross/Fine				
A	Single	—	2600	2660
B	Triple	—	2629	2685
C	Straphead	—	2650	2650
D	Triple	—	2604	2664
E	Fiddle	—	2655	2621
F	Cheek	—	2644	2606
G	Through-deck	—	046	047
H	Pivoting lead	—	2156	2156
4:1 with Dedicated Winch				
A	Single	—	6260	3231
B	Fiddle	—	6292	3241
C	Single w/becket	—	6261	3232
D	Footblock	—	6267	3234
E	Winch	—	40.2ST	46.2ST
5:1 with Dedicated Winch				
A	Single	2660	1540	3231
B	Fiddle w/ becket	2691	1560	3242
C	Footblock	1548	1548	3234
D	Winch	35.2ST	46.2ST	46.2ST
2:1 with Dedicated Winches				
A	Single	—	1586	3231
B	Single	—	1540	3215
C	Footblock	—	1548	3220
D	Winch	—	40.2ST	46.2ST
Admiral's Cup 2:1 with Dedicated Winches				
A	Double	—	1544	3233
B	Single	—	1586	3246
C	Single	—	1540	3231
D	Footblock	—	1548	3234
E	Winch	—	35.2ST	46.2ST
3:1 with Dedicated Winch				
A	Single w/becket	—	—	3247
B	Single	—	—	3246
C	Stand-up	—	—	3254
D	Winch	—	—	46.2ST

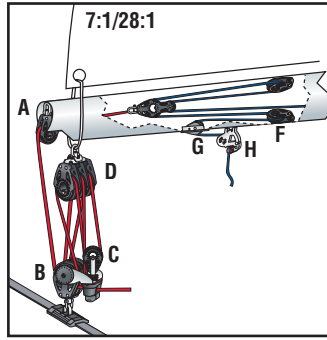

7:1/28:1 Gross/Fine: This gross-trim/fine-tune system is found on racing multihulls where it is desirable to split the gross-trim from the fine-tune. Placing the fine-tune in the boom provides a very clean system that the trimmer can get a hold of and put his weight into. The powerful cascading fine-tune portion is used to haul the boom in that last little bit.

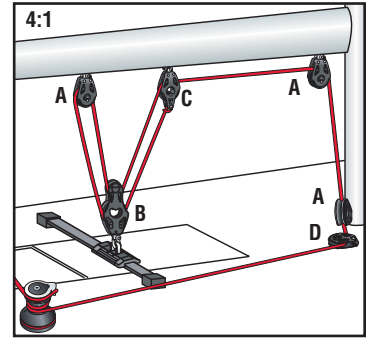

4:1 with Dedicated Winch: This system moves the traveler over the companionway to clean up the cockpit. A favorite on cruising boats.

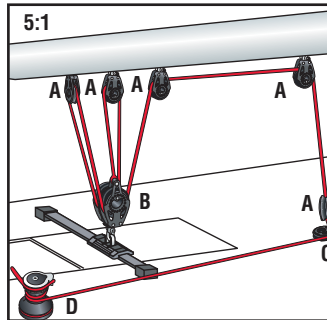

5:1 with Dedicated Winch: This system is popular on cruising boats with cabin-top travelers. The sheet leads forward to the gooseneck and then down and back to a winch on the aft edge of the cabin-top.

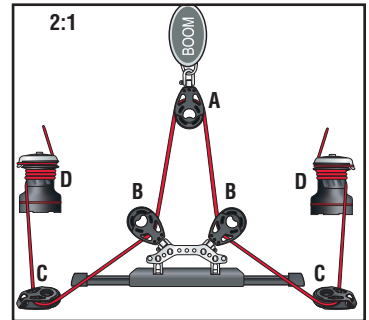

2:1 with Dedicated Winches: This simple double-ended system lets the mainsheet run freely through the blocks which allows the traveler car to move easily. The trimmer makes sail adjustments from the high side.

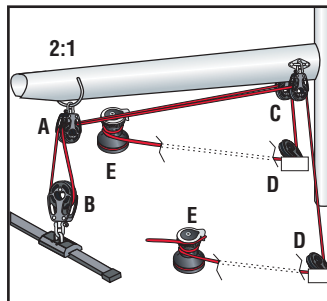

Admiral's Cup 2:1 with Dedicated Winches: In this system, the traveler is independent of the mainsheet so it rolls freely. The sheet leads forward along the boom before it turns down and aft to winches. Used on race boats like the Farr® 40.

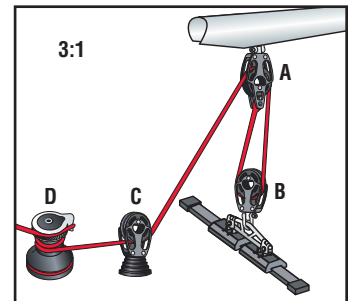

3:1 with Dedicated Winch: Many large boats use this simple 3:1 system. A block on deck turns the sheet to a winch.

Mainsheet

Two-Speed Mainsheets

Part numbers represent hardware most commonly used.

Typical boat length:

Small Boat: 6.7 - 8.5 m (22 - 28')

Midrange: 8.8 - 10.4 m (29 - 34')

Big Boat: 10.7 - 12.8 m (35 - 42')

Diagram Ref.	Description	Small Boat Part No.	Midrange Part No.	Big Boat Part No.
2:1/4:1 Swivel Base				
A	Double	2602	—	—
B	Single	2600	—	—
C	Double	2634	—	—
D	Cam base	402	—	—
3:1/6:1				
A	Cross block	400	400	—
B	Fiddle	401	401	—
3:1/6:1 Swivel Base				
A	Single	2600	2600	—
B	Double	2602	2602	—
C	Double	2634	2634	—
D	Cam base	402	402	—
4:1/8:1 Swivel Base				
A	Double	2602	2602	—
B	Cross block	400	400	—
C	Double	2634	2634	—
D	Cam base	402	402	—

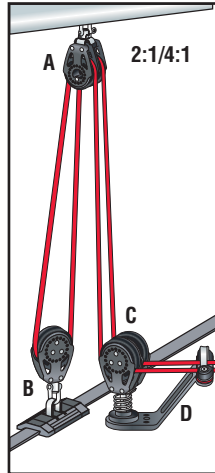

2:1/4:1 Swivel Base: This system is often found on boats like J/24s where a center-mounted swivel base is desired.

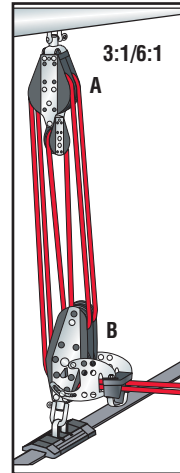

3:1/6:1: This 3:1/6:1 two-speed system is used on end-boom sheeting and mainsails where a center-mounted swivel base is desired.

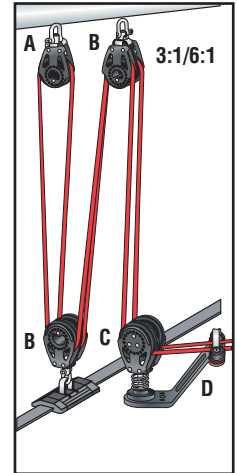

3:1/6:1 Swivel Base: This 3:1/6:1 system allows the mainsheet trimmer to be positioned anywhere on the boat. A great setup for sportboats.

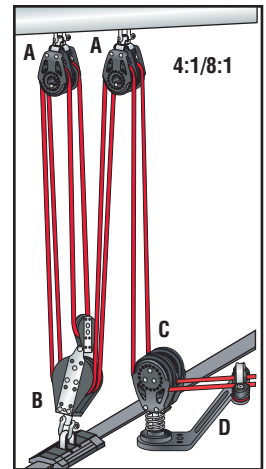

4:1/8:1 Swivel Base: Similar to the 3:1/6:1 swivel base system, but uses a 4:1/8:1 tackle for more power.



Boom Vangs

Part numbers represent hardware most commonly used.

Typical boat length:

Small Boat: 6.7 - 8.5 m (22 - 28')

Midrange: 8.8 - 10.4 m (29 - 34')

Big Boat: 10.7 - 12.8 m (35 - 42')

Diagram Ref.	Description	Small Boat Part No.	Midrange Part No.	Big Boat Part No.
4:1 V-Jam				
A	Double	226	—	—
B	Fiddle	245	—	—
4:1 Fiddle				
A	Fiddle	2655	2621	1559
B	Fiddle	2658	2624	1564
8:1 Cascaded Fiddle				
A	Single	300	304	308
B	Fiddle	2655	2621	1559
C	Fiddle	2658	2624	1564
4:1 Cascaded Kicker				
A	Fiddle	2655	2621	1559
B	Fiddle	2658	2624	1564
6:1 Double-ended Cascaded Kicker				
A	Triple	344	2640	2604
B	Double	342	2638	2602
C	Single	349	2652	2600
D	Cam cleat	241	240	240

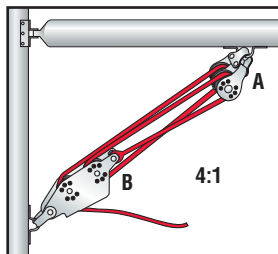

4:1 V-Jam: This simple 4:1 self-cleating vang is used on small dinghies.

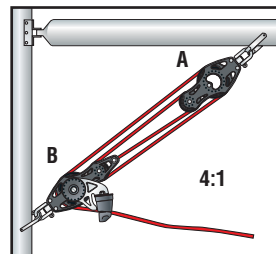

4:1 Fiddle: The basic 4:1 fiddle block vang is commonly used on dinghies and small keelboats.

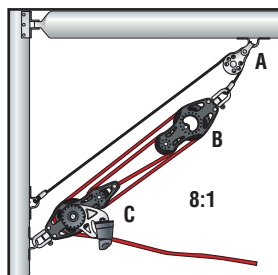

8:1 Cascaded Fiddle: A doubling block increases the purchase of the vang to 8:1. The load on the fiddle blocks is halved so they can be used safely on larger boats.

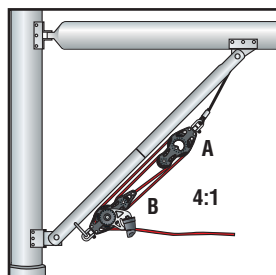

4:1 Cascaded Kicker: This rigid rod vang utilizes a simple 4:1 tackle. The rod also serves as a topping lift for the boom. Used on cruising and racing boats.

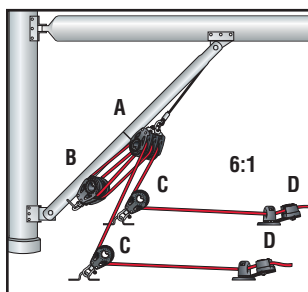

6:1 Double-ended Cascaded Kicker: Many racers rig the vang with a double-ended control line led down each side of the boat.



Outhaul Systems

Part numbers represent hardware most commonly used.

Typical boat length:

Small Boat: 6.7 - 8.5 m (22 - 28')

Midrange: 8.8 - 10.4 m (29 - 34')

Big Boat: 10.7 - 12.8 m (35 - 42')

Diagram Ref.	Description	Small Boat Part No.	Midrange Part No.	Big Boat Part No.
2:1 Internal				
A	Through-deck	106	302	306
B	Single	348	2650	2152
C	Through-deck	1200	1202	1203
D	Cam cleat	468	150	150
E	Single	349	2149	2149
4:1 External Cascade				
A	Eyestraps	281	137	1558
B	Cheek	350	2644	2606
C	Single	2146	2148	2152
D	Cam cleat	468	365	150
5:1 Internal				
A	Eyestraps	201	137	1558
B	Fiddle	2655	2621	2690
C	Fiddle	2656	2622	2691
D	Through-deck	1200	1202	1203
E	Through-deck	1200	1200	1200
F	Cam cleat	468	150	150
6:1 Internal				
A	Eyestraps	201	137	1558
B	Double	407	343	2639
C	Triple	408	344	2640
D	Traveler	2727	T2701B	T2701B.HL
E	Through-deck	1200	1202	1203
F	Through-deck	1200	1200	1200
G	Cam cleat	468	150	150
2:1 Furling Main				
A	Clew block	371	—	—
B	Traveler	G222B	1648	3076
C	Through-deck	1200	1202	1203

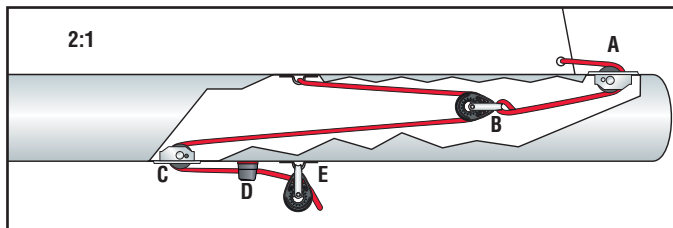

2:1 Internal: Suitable for dinghies or small keelboats. A flexible cable shackles to the sail and enters the boom through a wire block. Placing a block aft of the cleat allows the crew to pull from a variety of positions.

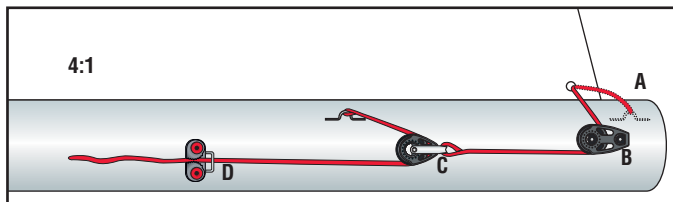

4:1 External Cascade: A simple external outhaul system. A cascade of two 2:1 tackles produces a 4:1 advantage.

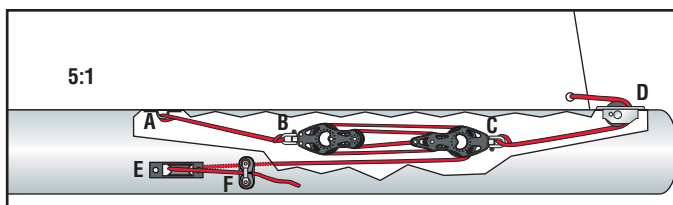

5:1 Internal: This 5:1 internal outhaul is popular on small offshore boats.

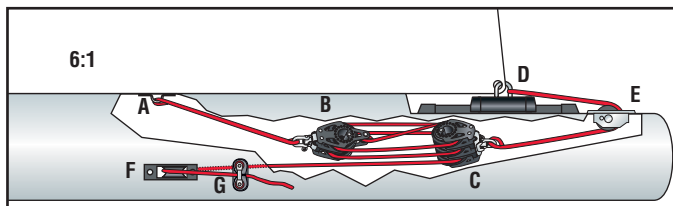

6:1 Internal: A 6:1 internal outhaul system is popular on small-to-medium-sized offshore boats using a traveler car to carry the clew of the mainsail.

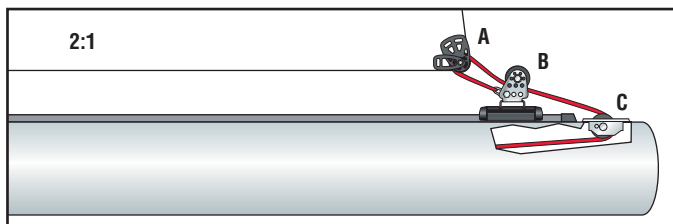

2:1 Furling Main: Mainsails that furl into the mast are loose-footed and usually have a ball bearing outhaul car that rides the length of the boom. The outhaul starts at the car, leads through the clew block on the sail, back to the sheave on the car, and into the boom where it leads to a winch.

Cunninghams

Part numbers represent hardware most commonly used.

Typical boat length:

Small Boat: 6.7 - 8.5 m (22 - 28')

Midrange: 8.8 - 10.4 m (29 - 34')

Big Boat: 10.7 - 12.8 m (35 - 42')

Diagram Ref.	Description	Small Boat Part No.	Midrange Part No.	Big Boat Part No.
4:1 Cascaded				
A	Single	2146	2148	—
B	Stand-up	349	2652	—
C	Cheek	350	2644	—
D	Cam cleat	470	458	—
8:1 Cascaded				
A	Fiddle	244	2655	2621
B	Fiddle	245	2658	2624
4:1 Double-Ended Cascaded				
A	Single	348	—	—
B	Pivoting lead	395	—	—
C	Cheek	233	—	—
12:1 Cascaded				
A	Triple	344	2640	2640
B	Triple	347	2648	2648
6:1 Double-Ended Jib Downhaul				
A	Single	2146	2149	2152
B	Cheek	350	2644	2606
C	Cam cleat	468	150	150
D	Bullseye	339	339	237

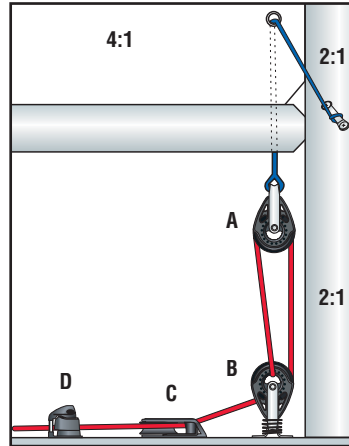

4:1 Cascaded: This simple 4:1 system leads aft to the cockpit. A favorite on small keelboats and daysailers.

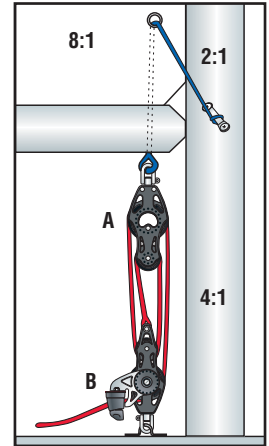

8:1 Cascaded: The most basic cunningham is a self-cleating 8:1 tackle positioned at the mastbase.

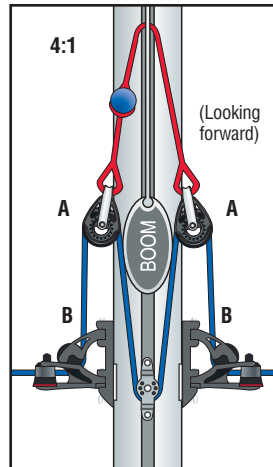

4:1 Double-ended Cascaded: This system is easy to adjust from the trapeze. It's easy to rig and unrig. Popular on smaller beachcats.

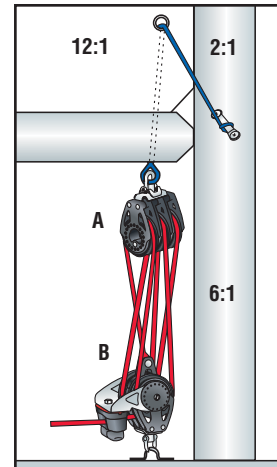

12:1 Cascaded: This simple 2:1 purchase is attached to a 6:1 cascade for a 12:1 system. Used on larger racing and cruising boats.

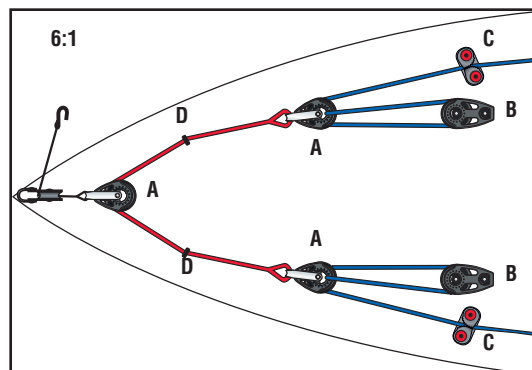

6:1 Double-ended Jib Downhaul: Small boats like J/24s use a double-ended genoa cunningham system to adjust draft from the weather rail.



Mastbase & Cabintop Blocks

Part numbers represent hardware most commonly used.

Typical boat length:

Small Boat: 6.7 - 8.5 m (22 - 28')

Midrange: 8.8 - 10.4 m (29 - 34')

Big Boat: 10.7 - 12.8 m (35 - 42')

Diagram Ref.	Description	Small Boat Part No.	Midrange Part No.	Big Boat Part No.
1 Halyard				
A	Mastbase	222	1986	1990
B	Cheek	2644	2606	3220
C	Single	2652	—	—
D	Flip-Flop	2142	3122	1987
3 Halyards				
A	Mastbase	222	1986	1990
B	Deck organizer	9001	9001	9006
C	Winch	20.2PTP	35.2PTP	40.2PTP
D	Single	2636	2660	1540
E	Stand-up spring	097	071	1634
F	Stand-up	2652	3227	3244
6 Halyards				
A	Mastbase	1986	1988	1990
B	Deck organizer	9001	9006	9006
C	Winch	20.2PTP	35.2PTP	40.2PTP
D	Crossover	—	1984	1981
Over the Top				
A	Mastbase	1986	1988	1990
B	Mastbase	1986	1988	1990
C	Mastbase	3002	3002	3002

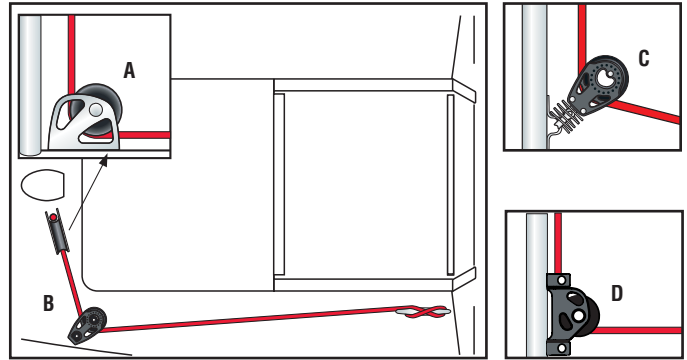

1 Halyard: This simple system leads principle halyards aft. Used by boats under 9 m (30').

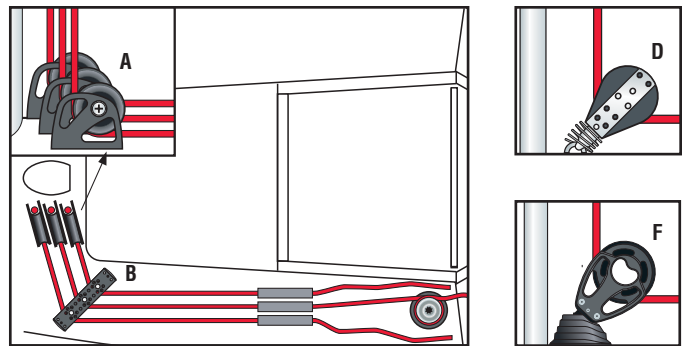

3 Halyards: Larger boats use special mastbase halyard lead blocks. Lines are routed out to deck organizers then aft to stoppers and winches. Stand-up blocks on a base are sometimes preferred for their complete articulation, but they hold halyards higher off the deck than specialized mastbase blocks.

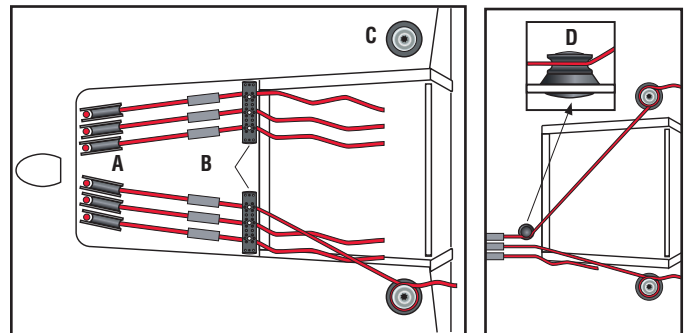

6 Halyards: Modern race boats lead halyards and control lines straight aft through deck organizers so they can be used on either cabintop winch.

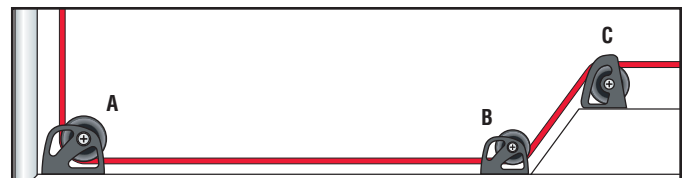

Over-the-Top: Special "over-the-top" blocks are required to route lines over an outside corner like the front of a doghouse or coaming.



Spinnaker

Part numbers represent hardware most commonly used.

Typical boat length:

Small Boat: 6.7 - 8.5 m (22 - 28')
 Midrange: 8.8 - 10.4 m (29 - 34')
 Big Boat: 10.7 - 12.8 m (35 - 42')

Diagram Ref.	Description	Small Boat Part No.	Midrange Part No.	Big Boat Part No.
Standard Sheets				
A	Single	2636	2600	—
B	Single	2637	2601	—
C	Bullseye	339	237	—
D	Single	340	2636	—
E	Single	2146	2149	—
F	Cam cleat	468	150	—
G	Single	2625	2660	—
Standard Sheets and Guys				
A	Single	—	2600	2660
B	Single	—	2636	2600
C	Bullseye	—	237	237
D	Stand-up	—	3227	3244
E	Cam cleat	—	150	150
F	Single	—	3226	3231
Asymmetrical on Sprit				
A	Single	2148	2660	3231
B	Bullseye	339	237	237
C	Cam cleat	150	150	280
D	Single	2680	1549/1571	3215
Continuous Line—Beachcat				
	Multihulls	2.4 - 4.3 m (8 - 14')	4.6 - 6 m (15 - 20')	6.4 - 9 m (21 - 30')
A	Single	2625	2625	2680
B	Single	2146	2148	2151

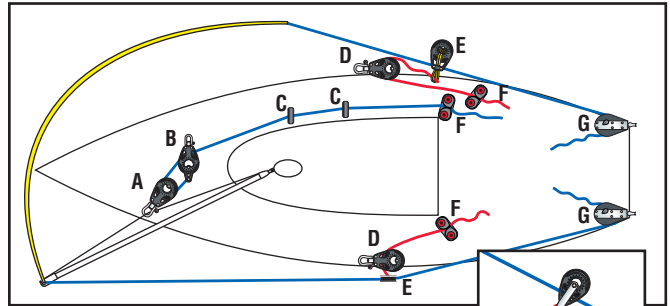

Standard Sheets: Masthead rigs to 8.5 m (28') and fractional rigs to 9.7 m (32') use one pair of lines which lead to turning blocks at the transom. Tweakers bring the guy to the deck near the point of maximum beam to provide additional control over the spinnaker pole. One foreguy line is appropriate for these boats.

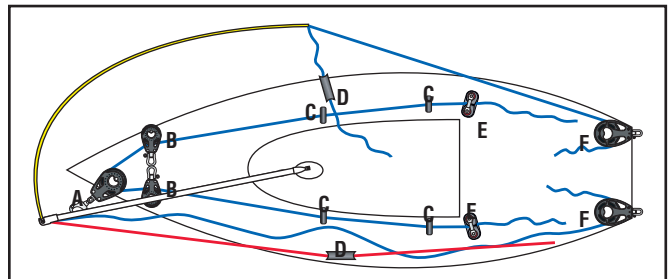
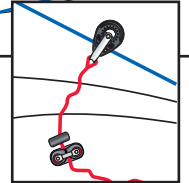

Standard Sheets & Guys: Offshore boats over 9 m (30') use separate sheets and guys. The sheets lead to turning blocks at the transom, while the guys lead to blocks at the point of maximum beam and then to a winch. A double-ended foreguy adjusts from either side of the boat.

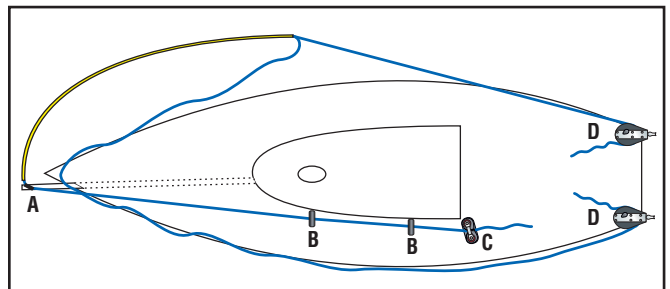

Asymmetrical on Sprit: Boats with asymmetrical spinnakers and retractable (or removable) bowsprits are rigged with a tack line leading through a block on the end of the sprit, and aft to a cleat or stopper. Two sheets attach to the clew of the sail, with the lazy sheet leading aft ahead of the headstay, over the sprit, and outside the shrouds and sheets.

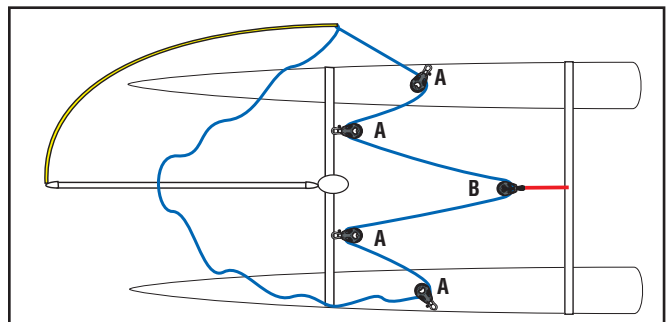

Continuous Line: Beachcats install two Carbo auto ratchets on each side of the boat to manage high spinnaker sheet loads. Use 57 mm ratchets on catamarans up to 6 m (20'). Use 75 mm ratchets on multihulls to 9 m (30').



Spinnaker Pole Handling & Halyards

Part numbers represent hardware most commonly used.

Typical boat length:

- Small Boat: 6.7 - 8.5 m (22 - 28')
- Midrange: 8.8 - 10.4 m (29 - 34')
- Big Boat: 10.7 - 12.8 m (35 - 42')

Diagram Ref.	Description	Small Boat Part No.	Midrange Part No.	Big Boat Part No.
2:1 Spinnaker Pole				
A	Spinnaker pole car	3188	3189	3097
B	Single	2146	2148	2148
C	Cam cleat	150	150	150
D	Cheek	350	2644	2644
E	Eyestraps	201	073	137

3:1 Spinnaker Pole				
A	Spinnaker pole car	3188	3189	3097
B	Single	2146	2149	2152
C	Cam cleat	150	150	150
D	Cheek	350	2644	2644

Spinnaker Halyard through Spar				
A	Exit block	089	134	—
B	Cam cleat	150	150	—

Pole Launcher				
A	Single	340	—	—
B	Single w/becket	341	—	—
C	Bullseye	237	—	—
D	Eyestraps	137	—	—

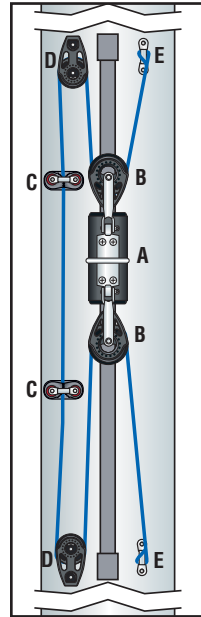

2:1 Spinnaker Pole: This system allows the inboard end of the pole to be moved under load. It features a continuous adjuster line and 2:1 controls.

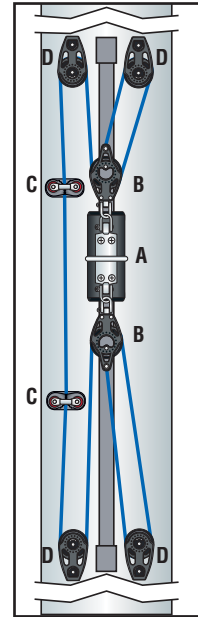

3:1 Spinnaker Pole: This adjustable system features 3:1 controls for more power.

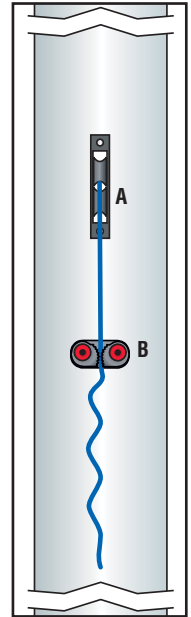

Spinnaker Halyard through Spar: Smaller offshore boats often mount a cam cleat below the spinnaker halyard exit so crew can jump the halyard and cleat it to the mast when setting the spinnaker. The cam also holds the line should the sail fill prematurely.

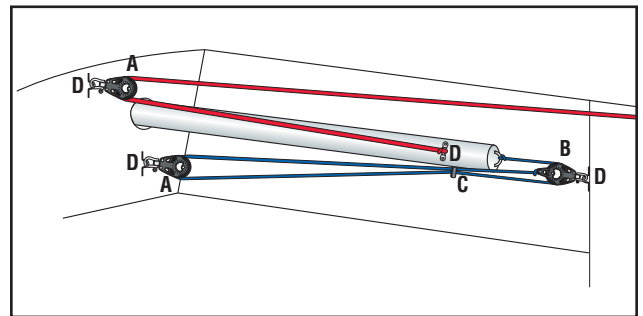

Pole Launcher: Many racing boats have asymmetrical spinnakers and retractable bowsprits. This system features a launcher line on top of the pole, with strong shockchord on the bottom to automatically retract the pole when the launcher line is uncleated.

Backstay Adjuster

Part numbers represent hardware most commonly used.

Typical boat length:

Small Boat: 6.7 - 8.5 m (22 - 28')

Midrange: 8.8 - 10.4 m (29 - 34')

Big Boat: 10.7 - 12.8 m (35 - 42')

Diagram Ref.	Description	Small Boat Part No.	Midrange Part No.	Big Boat Part No.
6:1 Right Angle				
A	Triple	2640	—	—
B	Triple	2648	—	—
12:1 Cascaded				
A	Single	300	—	—
B	Triple	344	—	—
C	Triple	347	—	—
4:1 Split Backstay				
A	Single	304	308	—
B	Fiddle	2621	2621	—
C	Fiddle	2624	2624	—
8:1 Split Backstay				
A	Single	304	308	—
B	Fiddle	2655	2621	—
C	Fiddle	2658	2624	—
6:1 Double-ended Split				
A	Single	300	304	—
B	Single	340	2600	—
C	Double	342	2602	—
D	Stand-up	349	2652	—
E	Cheek	350	2644	—
F	Cam cleat	150	150	—
Double-acting Hydraulic Backstay Adjuster				
A	Backstay adjuster	—	HCI025110345BCC.NG HCI040160385BCC.NG HCI035130345BCC.NG HCI045160385BCC.NG	—

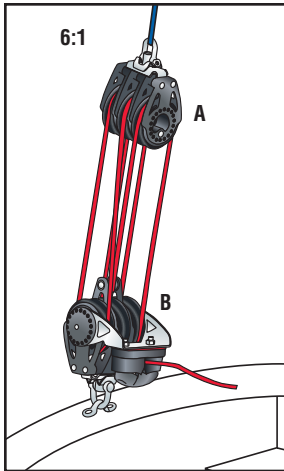

6:1 Right Angle: This simple 6:1 system is used on small cruising boats with a single line or wire backstay.

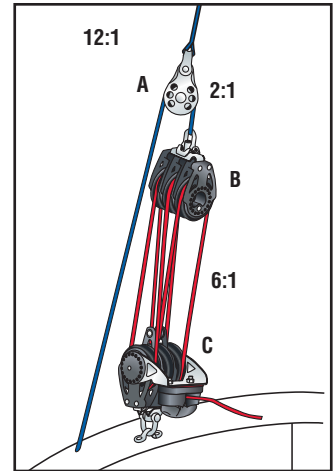

12:1 Cascaded: This cascading 2:1/6:1 system provides a 12:1 purchase and is used on small racer/cruisers and daysailers.

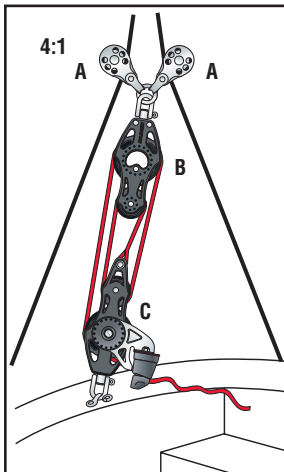

4:1 Split Backstay: This 4:1 system is used on small keelboats with split backstay systems. Pinching the wires together tightens the backstay and increases headstay tension to flatten the genoa, decrease weather helm, and stabilize the rig in heavy air.

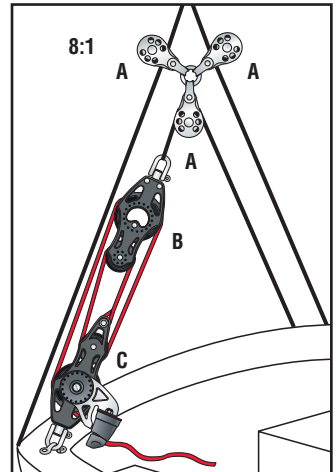

8:1 Split Backstay: A more powerful version of the split backstay adjuster uses a doubling wire running through a wire block for a purchase of 8:1.

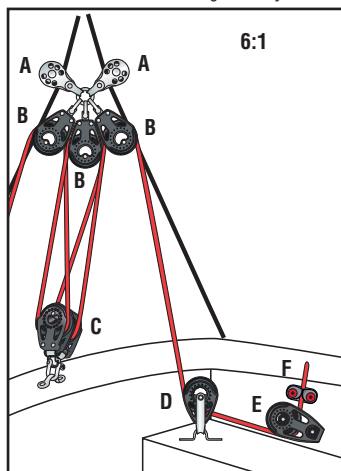

6:1 Double-ended Split: This double-ended split backstay system leads lines forward to cam cleats mounted just ahead of the helmsman so adjustments can be made from either side of the boat.

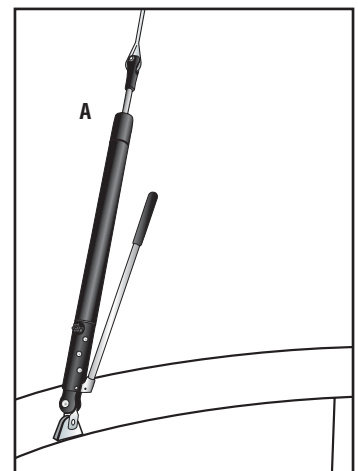

Double-acting Hydraulic Backstay Adjusters: These powerful systems deliver oil when the handle is pushed and pulled, delivering oil twice as fast as single-acting pumps—an excellent choice for racer/cruisers.



Mainsail Reefing

Part numbers represent hardware most commonly used.

Typical boat length:

Small Boat: 6.7 - 8.5 m (22 - 28')

Midrange: 8.8 - 10.4 m (29 - 34')

Big Boat: 10.7 - 12.8 m (35 - 42')

Diagram Ref.	Description	Small Boat Part No.	Midrange Part No.	Big Boat Part No.
Dual Line				
A	Cheek	2644	6237	3220
B	Single	2650	2600	3215
C	Mastbase block	222	1986	1988
D	Bullseye	339	237	237
Lazy Jacks				
A	Lazy Jack kit	252	253	254

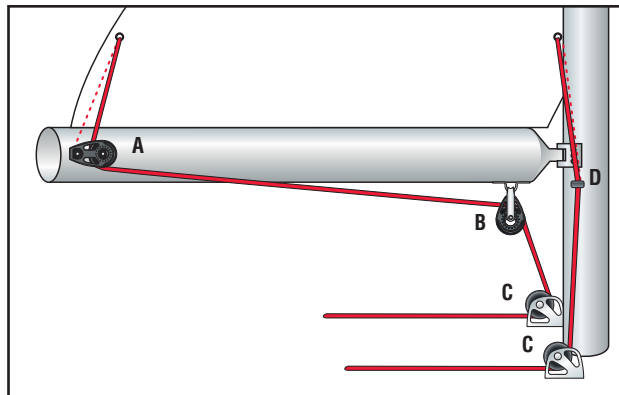

Dual Line: This dual-line system is common on boats 9 m (30') and larger. Position blocks so line pulls down and out to keep the sail flat and prevent lateral loads on the luff rope or luff sliders.

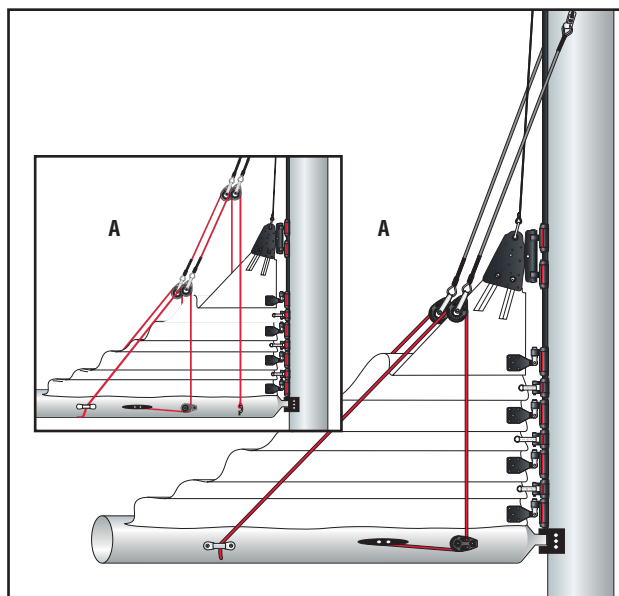

Lazy Jacks: Lazy Jacks contain mainsails during reefing and dousing. They work exceptionally well with full-battened mains, but are also used with conventional sails.



Self-Tacking Jibs & Staysails

Part numbers represent hardware most commonly used.

Typical boat length:

Small Boat: 6.7 - 8.5 m (22 - 28')
 Midrange: 8.8 - 10.4 m (29 - 34')
 Big Boat: 10.7 - 12.8 m (35 - 42')

Diagram Ref.	Description	Small Boat Part No.	Midrange Part No.	Big Boat Part No.
Standard Self-tacker				
A	Through-deck	1200	1202	1203
B	Single	2636	2600	3226/1540
2:1 Self-tacker				
A	Single	—	2660	3226
B	Padeye	1558	688	689
C	Cheek	6237	6267	3220
D	Single	—	2660	3215
Self-tacker on Jib Boom				
A	Furler	Unit 0	Unit 1	Unit 2
B	Double	2602	2662	3217
C	Single	2600	2660	3215
D	Single	2601	2661	3216
E	Deck organizer	9000	9005	9005

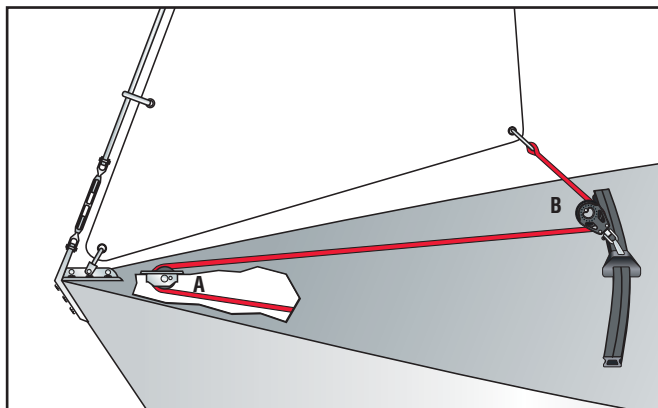

Standard Self-tacker: This system is often used on course racing keelboats like Solings. The traveler track is bent in a radius equal to the distance from the headstay to the sheeting point along the LP of the sail.

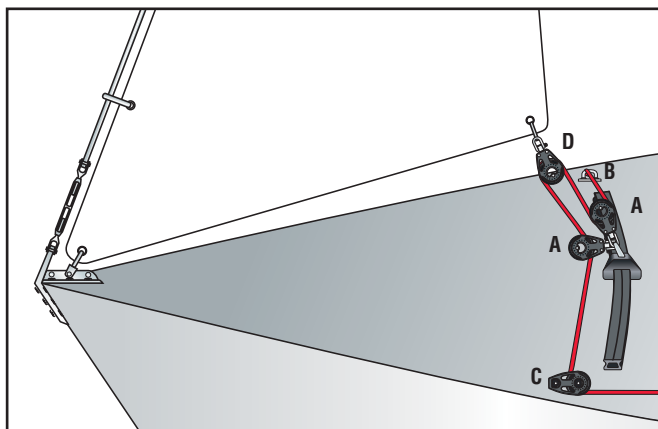

2:1 Self-tacker: Self-tacking jibs are popular because they keep the foredeck clean.

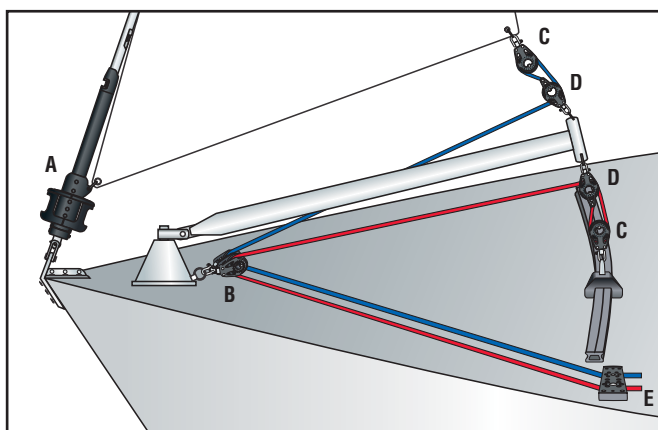

Self-tacker on Jib Boom: Self-tacking jibs and staysails work well with furling systems and jib booms. This system features two “sheets”—one controls the in and out movement of the sail much like an outhaul. The other controls the boom.



Metric Conversions

This catalog shows both imperial and metric measurements. In most cases, the metric dimension shown is calculated from the imperial measurement and rounded to a whole number. For example, 5/16" is generally shown as 8 mm, while an exact conversion would be 7.9375 mm. When referring to a line diameter, it is sufficient to approximate the conversion. In cases where a dimension is critical, exact metric dimensions are shown. For example, a clevis pin for a furling unit with a diameter of 1/2" is shown as 12.7 mm.

Length			Area		
When you know	Multiply by	To find	When you know	Multiply by	To find
Inches	25.40	Millimeters	Square inches	645.2	Square millimeters
Inches	2.540	Centimeters	Square inches	6.452	Square centimeters
Feet	304.80	Millimeters	Square feet	929.0	Square centimeters
Feet	30.48	Centimeters	Square feet	0.0929	Square meters
Feet	0.3048	Meters	Square yards	0.8361	Square meters
When you know	Divide by	To find	When you know	Divide by	To find
Millimeters	25.40	Inches	Square millimeters	645.2	Square inches
Centimeters	2.540	Inches	Square centimeters	6.452	Square inches
Millimeters	304.8	Feet	Square centimeters	929.0	Square feet
Centimeters	30.48	Feet	Square meters	0.0929	Square feet
Meters	0.3048	Feet	Square meters	0.8361	Square yards
Weight					
When you know	Multiply by	To find	When you know	Divide by	To find
Ounces	28.35	Grams	Grams	28.35	Ounces
Pounds	0.4535	Kilograms	Kilograms	0.4535	Pounds
Liquid					
When you know	Multiply by	To find	When you know	Multiply by	To find
Liters	0.26417	Gallons	Gallons	3.7854	Liters
Liters	2.1134	Pints	Pints	.4731	Liters

To use the online calculator for finding length, area and weight go to www.harken.com

Fastener Types

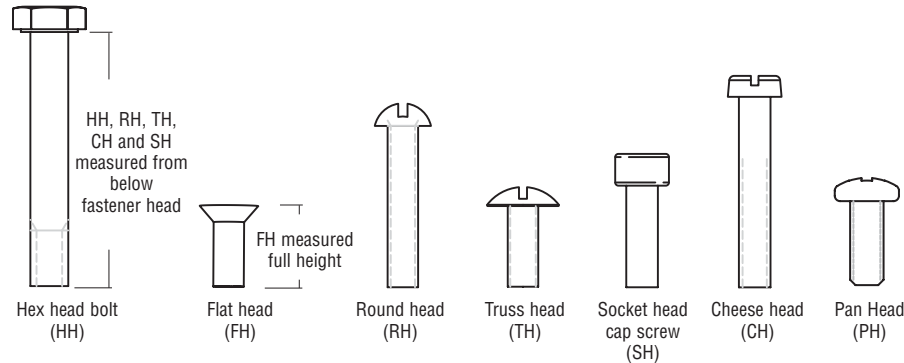







Equivalency Table

Fraction	Decimal	mm
1/32	0.0313	.7938
1/16	0.0625	1.5875
3/32	0.0938	2.3813
1/8	0.125	3.175
5/32	0.1563	3.9688
3/16	0.1875	4.7625
7/32	0.2188	5.5563
1/4	0.25	6.35
9/32	0.2813	7.1438
5/16	0.3125	7.9375
11/32	0.3438	8.7313
3/8	0.375	9.525
13/32	0.4063	10.3188
7/16	0.4375	11.1125
15/32	0.4688	11.9063
1/2	0.5	12.7
17/32	0.5313	13.4938
9/16	0.5625	14.2875
19/32	0.5938	15.0813
5/8	0.625	15.875
21/32	0.6563	16.6688
11/16	0.6875	17.4625
23/32	0.7188	18.2563
3/4	0.75	19.05
25/32	0.7813	19.8438
13/16	0.8125	20.6375
27/32	0.8438	21.4313
7/8	0.875	22.225
29/32	0.9063	23.0188
15/16	0.9375	23.8125
31/32	0.9688	24.6063

Drilling Guide

Fastener mm	Drill for clearance hole	Drill for tapping	Fastener	Drill for clearance hole	Drill for tapping
	mm	mm		in	
2	2.25	1.6	6-32	9/64	#36
2.5	2.75	2.05	8-32	11/64	#29
3	3.25	2.5	10-24	13/64	#25
4	4.25	3.25	10-32	13/64	#21
5	5.25	4.25	1/4-20	17/64	#7
6	6.25	5	5/16-18	21/64	#F
8	8.25	6.75	3/8-16	25/64	5/16"
10	10.25	8.5	7/16-14	29/64	#T
12	12.25	10.25	1/2-13	33/64	21/64"
16	16.26	14	5/8-11	41/64	11/32"

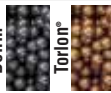
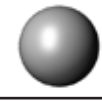
Ball Bearing Replacement Chart





Car	Bearing style	Part number		Description	Car width		Car length		# balls per car	Ball material	Ball kit		Ball diameter		Car loader		Car loader for CB+ to non-CB- Order
		CB+ car	CB-only car		in	mm	in	mm			Part No.	# Balls	in	mm	Included	Order	
																	
CB only		2700, 2701, 2702, 2703		Micro CB	1 9/16	40	2 3/16	56	40	Torlon	2708	20	3/16	5	—	—	
CB+		2726, 2728, 2730, 2732, 2744		Small Boat CB	2 3/16	56	2 7/8	73	40	Delrin	176	21	1/4	6	—	HSB116	
CB+		2727, 2729, 2731, 2733, 2734, 2745		Small Boat CB high-load	2 3/16	56	2 7/8	73	40	Torlon	177	21	1/4	6	—	HSB116	
CB+		2735, 2736, 2737, 2738, 2746		Small Boat CB 1250 series	2 3/16	56	4 1/8	105	60	Torlon	177	21	1/4	6	—	HSB116	
Non-CB		156, 157, 171, 211		Small Boat	2 3/16	56	2 7/8	73	42	Delrin	176	21	1/4	6	—	HSB116	
Non-CB		158, 159, 172, 210, 212		Small Boat high-load	2 3/16	56	2 7/8	73	42	Torlon	177	21	1/4	6	—	HSB116	
Non-CB		214, 215, 247, 440, 441		Small Boat 1250 series	2 3/16	56	4 3/8	111	64	Torlon	177	21	1/4	6	—	HSB116	
CB+		T2701B, T2702B, T2703B, T2705B, T2721B, T2722B, T2731B, T2732B, T2741B, T2742B		T27 Midrange CB	2 3/4	70	4 1/4	108	48	Torlon	1526	25	5/16	8	—	HMR2	
CB+		T2701B.HL, T2702B.HL, T2703B.HL, T2721B.HL, T2722B.HL, T2731B.HL, T2732B.HL, T2741B.HL, T2742B.HL		T27 Midrange CB high-load	2 3/4	70	5 3/16	132	60	Torlon	1526	25	5/16	8	—	HMR2	
CB+		T2704B.HL, T2744B.HL		T27 Midrange CB 2 cars with 2 toggles	2 3/4	70	4 1/4	108	48 x 2	Torlon	1526	25	5/16	8	—	HMR2 x 2	
CB+		1635		Midrange CB windward sheeting	2 3/4	70	4 1/4	108	48	Torlon	1526	25	5/16	8	—	HMR2	
CB+		1636		Midrange CB high-load windward sheeting	2 3/4	70	5 3/16	132	60	Torlon	1526	25	5/16	8	—	HMR2	
CB+		1624, 1628		Midrange CB	2 3/4	70	4 1/4	108	48	Torlon	1526	25	5/16	8	—	HMR2	
CB+		1629		Midrange CB long	2 3/4	70	5 3/16	132	60	Torlon	1526	25	5/16	8	—	HMR2	
CB only		1626, 1640		Midrange CB	2 3/4	70	4 1/4	108	48	Torlon	1526	25	5/16	8	—	—	
CB only		1625, 1627, 1641		Midrange CB long	2 3/4	70	5 3/16	132	60	Torlon	1526	25	5/16	8	—	—	
Non-CB		1508, 1575, 1594		Midrange	2 3/4	70	4 1/4	108	48	Torlon	1526	25	5/16	8	—	—	
Non-CB		1509, 1576, 1595		Midrange long	2 3/4	70	5 1/4	133	60	Torlon	1526	25	5/16	8	HMR2	—	
Non-CB		1604		Midrange with 2 toggles	2 3/4	70	7 1/4	184	86	Torlon	1526	25	5/16	8	HMR47	—	
CB+		T3201B, T3202B, T3203B, T3205B, T3221B, T3222B, T3231B, T3232B, T3241B, T3242B		T32 Big Boat CB 3000 series	3 5/16	85	5 3/8	136	50	Torlon	547	25	3/8	10	—	HBB1	
CB+		T3201B.HL, T3202B.HL, T3203B.HL, T3205B.HL, T3221B.HL, T3222B.HL, T3231B.HL, T3232B.HL, T3241B.HL, T3242B.HL, T3243B.HL		T32 Big Boat CB 4500 series	3 5/16	85	7 7/16	188	72	Torlon	547	25	3/8	10	—	HBB28	
CB+		T3204B, T3224B, T3234B, T3244B, T3209B		T32 Big Boat CB 5000 series with 2 toggles/stackles	3 5/16	85	9 1/8	231	90	Torlon	547	25	3/8	10	—	HBB25	
CB+		T3204B.HL, T3224B.HL, T3234B.HL, T3244B.HL, T3209B.HL		T32 Big Boat CB 2 high-load cars with 2 toggles	3 5/16	85	7 7/16	188	72 x 2	Torlon	547	25	3/8	10	—	HBB28 x 2	
CB+		T3208B		T32 Big Boat CB 2 cars with 2 toggles	3 5/16	85	5 3/8	136	50 x 2	Torlon	547	25	3/8	10	—	HBB1 x 2	
CB+		3176, 3177		Big Boat CB 3000 series windward sheeting	3 5/16	85	5 3/8	136	50	Torlon	547	25	3/8	10	—	HBB1	
CB+		3178, 3179		Big Boat CB 4500 series windward sheeting	3 5/16	85	7 7/16	188	72	Torlon	547	25	3/8	10	—	HBB28	
CB+		3160, 3163, 3164		Big Boat CB 3000 series	3 5/16	85	5 3/8	136	50	Torlon	547	25	3/8	10	—	HBB1	
CB+		3161, 3165, 3166		Big Boat CB 4500 series	3 5/16	85	7 7/16	188	72	Torlon	547	25	3/8	10	—	HBB28	

Delrin is a registered trademark of E. I. du Pont de Nemours and Company or its affiliates.

Torlon is a registered trademark of Solvay Advanced Polymers L.L.C.











Car	Bearing style	Part number		Description	Car width		Car length		# balls per car	Ball material	Ball kit		Ball diameter		Car loader		Car loader for CB+ to non-CB
		CB+ car	CB-only car		in	mm	in	mm			Part No.	# Balls	in	mm	Included	Order	
					3 5/16	85	9 1/8	231	90	Delrin® Torlon®	547	25	3/8	10	—	—	
CB only		3167		Big Boat CB 5000 series with 2 toggles/shackles	3 5/16	85	9 1/8	231	90	Torlon	547	25	3/8	10	—	—	
Non-CB		515, 608, 1928, 1930		Big Boat 3000 series	3 5/16	85	5 1/4	133	50	Torlon	547	25	3/8	10	HBB1	—	
Non-CB		558, 609, 1929, 1931		Big Boat 4500 series	3 5/16	85	7 1/4	184	72	Torlon	547	25	3/8	10	HBB28	—	
Non-CB		1939		Big Boat 5000 series with 2 toggles/shackles	3 5/16	85	8 1/2	216	90	Torlon	547	25	3/8	10	HBB25	—	
Non-CB		1941		Big Boat 6000 series with 3 toggles/shackles	3 5/16	85	10 1/2	267	110	Torlon	547	25	3/8	10	HBB25	—	
Non-CB		3074		Big Boat CRX	3 5/16	85	5	127	102	Torlon	H-38349A	Rollers	—	—	—	—	
Non-CB		3075		Big Boat CRX	3 5/16	85	7 1/2	191	148	Torlon	H-38349A	Rollers	—	—	—	—	
Non-CB		3068		Mini-Maxi	4 3/8	111	10	254	72	Torlon	MP-128	1	1/2	12	HBB39	—	
Non-CB		3070		Maxi	5 1/4	133	13 7/8	353	104	Torlon	MP-128	1	1/2	12	HBB32	—	
CB+		3188		Small Boat CB ring	2 3/16	56	4 1/8	105	60	Torlon	177	21	1/4	6	—	—	HSB116
Non-CB		780		Spinnaker pole	2 3/16	56	4 3/8	111	64	Torlon	177	21	1/4	6	HSB116	—	
CB+		1645, 1646, 1647		Midrange CB	2 3/4	70	5 3/16	132	60	Torlon	1526	25	5/16	8	—	—	HMR2
CB+		3189		Midrange CB ring	2 3/4	70	5 3/16	132	60	Torlon	1526	25	5/16	8	—	—	HMR2
Non-CB		1578		Midrange 120/130 bell	2 3/4	70	5 1/4	133	60	Torlon	1526	25	5/16	8	HMR2	—	
Non-CB		1579, 1580		Midrange toggle	2 3/4	70	5 1/4	133	60	Torlon	1526	25	5/16	8	HMR2	—	
CB+		3097		Big Boat CB 120/130 bell	3 5/16	85	7 7/16	188	72	Torlon	547	25	3/8	10	—	—	HBB28
CB+		3098, 3099		Big Boat CB toggle	3 5/16	85	7 7/16	188	72	Torlon	547	25	3/8	10	—	—	HBB28
Non-CB		782		Big Boat 120/130 bell	3 5/16	85	7 1/4	184	72	Torlon	547	25	3/8	10	HBB28	—	
Non-CB		783, 784		Big Boat toggle	3 5/16	85	7 1/4	184	72	Torlon	547	25	3/8	10	HBB28	—	
CB+		G222B, G224B, G2227B, G2247B		Small Boat CB	2 3/16	56	4 1/8	105	60	Torlon	177	21	1/4	6	—	—	HSB116
Non-CB		249		Small Boat	2 3/16	56	4 3/8	111	64	Torlon	177	21	1/4	6	HSB116	—	
CB+		G272B, G273B, G274B, G2727B, G2737B, G2747B		Midrange CB	2 3/4	70	5 3/16	132	60	Torlon	1526	25	5/16	8	—	—	HMR2
CB+		G273B.HL, G274B.HL, G2737B.HL, G2747B.HL		Midrange CB	2 3/4	70	9	229	96	Torlon	1526	25	5/16	8	—	—	Contact Harken
Non-CB		1537		Midrange	2 3/4	70	5 1/4	133	60	Torlon	1526	25	5/16	8	HMR2	—	
CB+		G323B, G324B, G3237B, G3247B		Big Boat CB	3 5/16	85	9 1/8	231	90	Torlon	547	25	3/8	10	—	—	HBB25
Non-CB		554		Big Boat	3 5/16	85	7 1/4	184	72	Torlon	547	25	3/8	10	HBB28	—	
Non-CB		587		Big Boat	3 5/16	85	5 1/4	133	50	Torlon	547	25	3/8	10	HBB1	—	
Non-CB		HC4928		Big Boat	3 5/16	85	10 1/4	260	104	Torlon	547	25	3/8	10	HBB25	—	
Non-CB		3072		Mini-Maxi	4 3/8	111	13 11/16	348	84	Torlon	MP-128	1	1/2	12	—	—	

TRAVELER

SPINNAKER POLE

GENOA LEAD

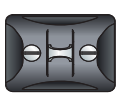
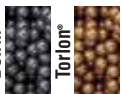
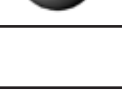
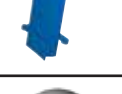
Delrin is a registered trademark of E. I. du Pont de Nemours and Company or its affiliates. Torlon is a registered trademark of Solvay Advanced Polymers L.L.C.

Car	Bearing style	Part number		Description	Car width		Car length		# balls per car	Ball material	Ball kit		Ball diameter		Car loader		Car loader for CB+ to non-CB
		CB+ car	CB-only car		in	mm	in	mm			Part No.	# Balls	in	mm	Included	Order	
																	
	CB+	1648		Midrange CB	2 3/4	70	5 3/16	132	60	Torlon	1526	25	5/16	8	—	—	HMR2
	Non-CB	1615		Midrange	2 3/4	70	5 1/4	133	60	Torlon	1526	25	5/16	8	HMR2	—	—
	CB+	3076		Big Boat CB 3000 series	3 5/16	85	5 1/4	133	50	Torlon	547	25	3/8	10	—	—	HBB1
	CB+	3096		Big Boat CB 4500 series	3 5/16	85	7 1/4	184	72	Torlon	547	25	3/8	10	—	—	HBB28
	Non-CB	595		Big Boat 3000 series	3 5/16	85	5 1/4	133	50	Torlon	547	25	3/8	10	HBB1	—	—
	Non-CB	1771		Big Boat 4500 series	3 5/16	85	7 1/4	184	72	Torlon	547	25	3/8	10	HBB28	—	—
	CB only	3813		System AA CB headboard	1 9/16	40	2 3/16	132	40 x 2	Torlon	2708	20	3/16	5	—	—	—
	CB only	3815		System AA CB intermediate car	1 9/16	40	2 3/16	56	40	Delrin	492	20	3/16	5	—	—	—
	CB only	3816		System AA CB Battcar	1 9/16	40	2 3/16	56	40	Torlon	2708	20	3/16	5	—	—	—
	CB+	3811		System A CB headboard	2 3/16	56	4 1/8	105	60 x 2	Torlon	177	21	1/4	6	—	—	HSB116 x 2
	CB+	3812		System A CB intermediate car	2 3/16	56	2 1/4	57	30	Torlon	177	21	1/4	6	—	—	HSB116
	CB+	3829, 3830, 3831, 3881		System A CB Battcar	2 3/16	56	2 7/8	73	40	Torlon	177	21	1/4	6	—	—	HSB116
	CB+	3882, 3883		System A CB high-load	2 3/16	56	4 1/8	105	60	Torlon	177	21	1/4	6	—	—	HSB116
	Non-CB	1792, 1807		System A headboard car	2 3/16	56	3 5/8	92	52 x 2	Delrin/Torlon*	177	21	1/4	6	HSB116 x 2	—	—
	Non-CB	1925, 1901, 1944, 1976, 1977		System A Battcar	2 3/16	56	3	76	40	Delrin/Torlon*	177	21	1/4	6	HSB116	—	—
	Non-CB	1894		System A luff car	2 3/16	56	2 1/8	54	30	Delrin/Torlon*	177	21	1/4	6	HSB116	—	—
	CB+	3852		System B CB headboard	2 3/4	70	5 3/16	132	60 x 2	Torlon	1526	25	5/16	8	—	—	HMR2 x 2
	CB+	3863		System B CB intermediate car	2 3/4	70	2 9/16	68	28	Torlon	1526	25	5/16	8	—	—	HMR2
	CB+	3856, 3857, 3859, 3879		System B CB Battcar	2 3/4	70	4 5/16	109	48	Torlon	1526	25	5/16	8	—	—	HMR2
	CB+	3860		System B CB reef car	2 3/4	70	5 3/16	132	60	Torlon	1526	25	5/16	8	—	—	HMR2
	Non-CB	1793		System B headboard car	2 3/4	70	4 3/8	111	48 x 2	Delrin/Torlon*	1526	25	5/16	8	HMR2 x 2	—	—
	Non-CB	1979		System B intermediate car	2 3/4	70	3 13/16	97	40	Delrin/Torlon*	1526	25	5/16	8	HMR2	—	—
	Non-CB	1794, 1826, 1902, 1946, 1976, 1980		System B Battcar	2 3/4	70	3 13/16	97	40	Delrin/Torlon*	1526	25	5/16	8	HMR2	—	—
	Non-CB	1895		System B luff car	2 3/4	70	2 3/4	70	30	Delrin/Torlon*	1526	25	5/16	8	HMR2	—	—
	CB+	3867		System C CB headboard	3 5/16	85	9 1/8	232	90 x 2	Torlon	547	25	3/8	10	—	—	HBB25 x 2
	CB+	3871		System C CB intermediate car	3 5/16	85	3 3/4	96	34	Torlon	547	25	3/8	10	—	—	HBB1
	CB+	3868, 3869, 3870, 3872		System C CB Battcar	3 5/16	85	5 3/8	136	50	Torlon	547	25	3/8	10	—	—	HBB1
	CB+	3873		System C CB reef car	3 5/16	85	9 1/8	231	90	Torlon	547	25	3/8	10	—	—	HBB25
	Non-CB	1782		System C headboard car	3 5/16	85	5 1/2	140	52 x 2	Torlon	547	25	3/8	10	HBB1 x 2	—	—
	Non-CB	1784, 1795, 1827, 1828, 1829, 1903		System C Battcar	3 5/16	85	4 3/4	121	44	Torlon	547	25	3/8	10	HBB1	—	—
	Non-CB	1785		System C luff car	3 5/16	85	4	102	36	Torlon	547	25	3/8	10	HBB1	—	—
	Non-CB	1785HL		System C high-load luff car	3 5/16	85	4	102	36	Torlon	547	25	3/8	10	HBB1	—	—

OUTHAUL

BATTCAR

*Torlon bearings used on all high-load "HL" cars. Delrin is a registered trademark of E. I. du Pont de Nemours and Company or its affiliates. Torlon is a registered trademark of Solvay Advanced Polymers L.L.C.



Typical Rigging Breaking Loads†

Type 316 1 x 19 (25) Compacted Strand, example Dyform® wire rigging				Type 316 1 x 19* Stainless Wire Rope				Nitronic® 50 Stainless Rod Rigging, example Navtec®				Dacron® Double Braid Rope				Vectran® Core Rope w/Dacron Cover‡												
Breaking load		Size		Breaking load		Size		Breaking load		Size		Breaking load		Size		Breaking load		Size										
lb	kg	mm	in	lb	kg	mm	in	lb	kg	mm	in	lb	kg	mm	in	lb	kg	mm	in									
3/16	4928	2235	5	5380	2440	3/16	3960	1800	3/8	14500	6580	-4	0.172	4.37	4700	2130	1/4	1800	815	6	1800	815	3/16	634	288			
1/4	8844	4011	6	7828	3550	7/32	5445	2470	1/2	25680	11650	-6	0.198	5.03	6300	2860	5/16	2800	1270	7	2800	1270	1/4	1179	535			
9/32	10802	4899	7	10827	4910	1/4	7090	3220	—	—	—	-8	0.225	5.72	8200	3720	3/8	3750	1700	9	3750	1700	5/16	1677	761			
5/16	13530	6136	8	13561	6150	Type 302 1 X 19* Stainless Wire Rope				-10	0.250	6.35	10300	4670	7/16	5500	2490	11	5500	2490	3/8	2630	1193					
3/8	19272	8740	10	21544	9770	in	lb	kg	in	lb	kg	-12	0.281	7.14	12500	5670	1/2	7000	3175	12	7000	3175	7/16	3174	1439			
7/16	26620	12072	11	26620	12072	1/16	500	227	9/32	10300	4671	-15	0.296	7.52	14250	6460	9/16	10000	4535	14	10000	4535	1/2	3809	1727			
1/2	34833	15797	14	42460	19256	3/32	1200	544	5/16	12500	5669	-17	0.33	8.38	17500	7940	5/8	14000	6350	15	14000	6350	V12 Vectran					
9/16	42460	19256	16	56320	25541	1/8	2100	952	3/8	17500	7936	-22	0.375	9.53	22500	10200	3/4	16000	7250	19	16000	7250	in	lb	kg			
5/8	56320	25541	19	70400	31926	5/32	3300	1497	7/16	23400	10612	-30	0.437	11.1	30000	13600	7/8	25000	11340	22	25000	11340	1/8	2000	907			
3/4	70400	31926	—	—	—	3/16	4700	2131	1/2	29700	13469	-40	0.500	12.7	38000	17200	100% Spectra®/Dyneema® Core Rope w/Dacron Cover				5/32	3500	1587					
Type 316 1 x 19** Stainless Wire Rope				7/32	6300	2857	9/16	36500	16553	-48	0.562	14.27	48000	21800	Size		Breaking load		Size		Breaking load		Size		Breaking load			
mm	lb	kg	mm	lb	kg	mm	in	lb	kg	mm	in	lb	kg	mm	in	lb	kg	mm	in	lb	kg	mm	in	lb	kg			
2	706	320	9	12944	5870	1/4	8200	3719	5/8	44000	19954	-60	0.660	16.76	60000	27200	1/4	5100	2313	1/4	5100	2313	1/4	7800	3537			
2.5	1103	500	9.53	14509	6580	Type 316 7 x 19** Stainless Wire Rope				-76	0.705	17.91	76000	34500	5/16	6200	2812	5/16	6200	2812	5/16	6200	2812	5/16	11500	5215		
3	1588	720	10	15987	7250	in	lb	kg	mm	in	lb	kg	-91	0.768	19.51	90000	40800	3/8	9800	4444	3/8	9800	4444	3/8	16800	7618		
4	2822	1280	11	19338	8770	3/16	2830	1285	3	1120	510	-115	0.875	22.23	115000	52200	7/16	14000	6349	7/16	14000	6349	7/16	14000	6349	7/16	14000	6349
4.76	3969	1800	12	22933	10400	7/32	3865	1750	4	2130	970	-150	1.000	25.40	150000	68000	1/2	21000	9524	1/2	21000	9524	1/2	21000	9524			
5	4410	2000	12.7	25689	11650	1/4	5040	2280	5	3130	1420	-170	1.066	27.08	170000	77100	3/8	11350	5150	6 (-8)	4490	2040	5/32	—	—			
5.56	5447	2470	14	31268	14180	1/2	20165	9140	7 (-12)	6120	2780	-195	1.125	28.58	190000	86200	-220	1.191	30.25	217000	99400	3/16	5800	2630				
6	6351	2880	16	40926	18560	—	—	—	8	8000	3630	-260	1.313	33.35	260000	118000	1/2	20165	9140	7 (-12)	6120	2780	1/4	9800	4443			
6.35	7100	3220	19	47674	21620	—	—	—	10	12500	5670	-320	1.500	38.10	320000	145000	3/8	19000	8617	3/8	19000	8617	5/16	13300	6032			
7	7828	3550	22	64101	29070	—	—	—	12	17990	8160	—	—	—	—	—	—	—	—	—	—	—	—	—	—			
8	10232	4640	26	89526	40600	—	—	—	14	24470	11100	—	—	—	—	—	—	—	—	—	—	—	—	—	—			
—	—	—	—	—	—	—	—	—	16	29980	13600	—	—	—	—	—	—	—	—	—	—	—	—	—	—			

*Typical American wire. **Typical European wire. †Breaking load may vary widely by manufacturer.

Dacron is a registered trademark of E. I. du Pont de Nemours and Company or its affiliates.

Dyform is a registered trademark of Bridon International Ltd.

Dyneema is a registered trademark of DSM IP Assets B.V. L.L.C.

Navtec is a registered trademark of Lewmar, Ltd.

Nitronic is a registered trademark of AK Steel Corporation.

Spectra is a registered trademark of Honeywell International, Inc.

Vectran is a registered trademark of Kuraray Co., Ltd.

Loading Formulas

Block Loading vs Angle of Deflection

Load on a block is a combination of the load on the line passing through the block, plus a block-loading factor, which is determined by the angle by which the block turns the sheet. For example, a foot-block that turns a sheet 180 degrees will see a load equal to twice the load on the sheet. A deck organizer, which turns a halyard only 30 degrees, will see just 52 percent of the load on the halyard.

Boat Type

Most load formulas assume a medium displacement monohull, but you can easily correct for other boat types. Multihulls and boats with canting keels or water ballast have great form stability and speed and will often carry sails very high in the apparent wind speed, so calculations must be done with this wind speed in mind. ULDBs are typically tender and often change sails or reef quite early, so loading may be done at relatively low wind speeds. For example, a modern trimaran may carry its blade jib in 25 knots of wind at speeds over 15 knots for an apparent wind of nearly 40 knots, whereas a ULDB will probably remove its #1 genoa at about 15 knots of apparent wind.

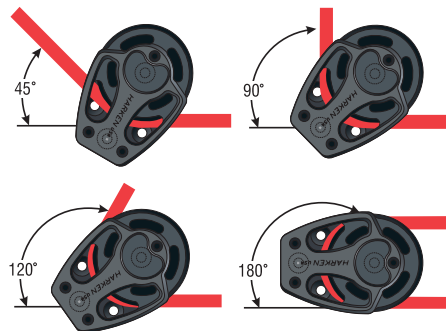

Angle of deflection	Load factor	Angle of deflection	Load factor	Angle of deflection	Load factor
30°	52%	90°	141%	150°	193%
45°	76%	105°	159%	160°	197%
60°	100%	120°	173%	180°	200%
75°	122%	135°	185%		

Genoa System Loading

Because wind speed is squared, it is the most important variable and can greatly influence loading. Wind speed (the apparent wind) should be calculated for the specific sail being analyzed. For example, the #1 genoa on a 7 m (25') boat might only be carried in 15 knots of wind, while the #3 blade on a Maxi-boat could well be carried in 40 knots.

To calculate loading on a genoa lead car, multiply sheet load by the load factor of the sheet. Most #1 genoas will deflect about 45 degrees, while a #3 genoa may deflect 75 degrees or more.

Lead car adjuster tackle load is dependent on the angle of deflection of the sheet in the lead car, but is generally assumed to be 0.3 of lead car load when deflection is 45 degrees and .05 of lead car load when deflection is 60 degrees.

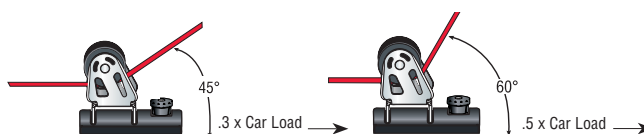

Genoa sheet load

English		Metric	
SL = SA x V ² x 0.00431		SL = SA x V ² x 0.02104	
SL	Sheet load in pounds	SL	Sheet load in kilograms
SA	Sail area in square feet	SA	Sail area in square meters
V	Wind speed in knots	V	Wind speed in knots

Formulas are for typical cruising monohulls with fixed keel and Dacron® sails, sheets, and halyards. For all other types, please contact Harken for technical assistance in calculating loads.

Mainsheet System Loading

The formula for mainsheet loading is not as widely accepted as that for genoa sheet loads and should only be used as a rough guide for offshore boats from 9 - 18 m (30 - 60').

Traveler car adjuster load is generally considered to be 0.2 times car load.

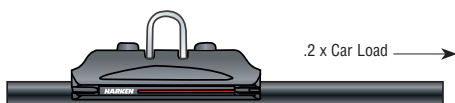

Mainsheet load

English		Metric	
ML = E ² x P ² x 0.00431 x V ² / (√(P ² + E ²) x (E - X))		ML = E ² x P ² x 0.02104 x V ² / (√(P ² + E ²) x (E - X))	
ML	Mainsheet load in pounds	ML	Mainsheet load in kilograms
E	Foot length of main in feet	E	Foot length of main in meters
P	Luff length of main in feet	P	Luff length of main in meters
V	Wind speed in knots	V	Wind speed in knots
X	Distance from aft end of boom to mainsheet attachment point in feet	X	Distance from aft end of boom to mainsheet attachment point in meters

Formulas are for typical cruising monohulls with fixed keel and Dacron sails, sheets, and halyards. Assumes standard roach of 7.5%. For large roach sails such as "flattops" multiply calculated load by the percentage of the mainsail roach. If a sail has 25% roach, multiply the calculated load by 1.25. For all other types, please contact Harken for technical assistance in calculating loads.

Rig Dimensions

The following abbreviations are often used to describe various measurements on a sailboat. Precise technical definitions exist for each abbreviation, but the following is a list of simple descriptions:

LOA	Length overall - overall tip-to-tip length of the boat	l ₂	Height of staysail halyard above deck
LWL	Length waterline - length of waterline of the boat	J	Base of the foretriangle measured from the front of the mast to the intersection of the forestay and deck
DWL	Design waterline - theoretical waterline length of boat as opposed to LWL, which is actual waterline length	J ₂	Base of staysail triangle
BMX	Beam maximum - width of the boat at the widest point	P	Luff length of the mainsail
BWL	Beam waterline - widest beam of boat at the waterline	E	Foot length of the mainsail
I	Height of the foretriangle measured from the top of the highest sheave to the sheerline	LP	Shortest distance from headstay to the clew of the jib

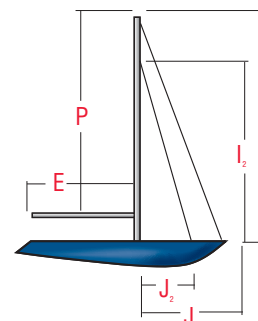

Dacron is a registered trademark of E. I. du Pont de Nemours and Company or its affiliates.

Index

All blocks (see "BLOCKS")
All cars (see "TRAVELERS")
All winches (see "WINCHES")

A

Accessories..... 73-74, 77, 102, 104, 107,
..... 109, 112, 115, 119, 190, 220-222, 249
Access Rail 130-131
Addresses 294-295
Athwartship Systems, Custom..... 123-124

B

Backstay Adjuster, Hydraulic..... 230
Backstay, Plate for Split 44
Backstay Systems Drawings 271
Ball Bearing Replacement Chart..... 275-277
Ball Bearing Winch Handles 220-221

Bases

Ball and Socket..... 76
Cam 75
Custom Removable Padeyes 90
Eyestraps 88
Padeyes 89-90
Stand-Up 76
Swivel 75-76
Batten Traveler Systems 133-153
Battcars 133-153
Bearings, Replacement 275-277
Below-Deck Furling 157, 172-175
Bends, Track 127
Big Boat Travelers 115-120, 122-124
Block Covers 58
Block Socks 58
Bolt-Down Fairleads 92
Boom Vangs, Hydraulic 237-238
Breaking Strengths, Rigging 278
Bullseye Fairleads 75, 77

BLOCKS

16 mm 35
Air Blocks..... 20-32, 52-59
Air Runners 58
Anti-Capsize 35-36
Backstay, Runners 58
Big Boat 45-67
Black Magic Air Blocks 52-59
Carbon Fiber 66-67
Cruising ESP 61
Custom 62, 64
Element 48-51
FlatWinder 60
Flip-Flop..... 64
Footblock..... 49-51, 59-62
Loop 54-57, 65-67
Low-Load 54-55
Mastbase 61-64
Megayacht 62, 65
Over-the-Top 64
Powered 60
Runner 58
Snatch 65
Spriddle 55
Stainless Steel 61-62
Stand-Up 49-51, 54-57, 62
Swivel 49-51, 54-57, 61-62
Teardrop 59, 61-62
V 66-67
Big Bullet 38-39

Bullet 38-39
Carbo Air Blocks 20-32
29 mm 21-22
40 mm 21, 23-24, 28-29, 32
57 mm 21, 25, 27-32
75 mm 26-32
Clew Block Assembly 22
Fiddle 32
Fixed Head 22-23
HTE Ratchamatic 27
Loop 21
Quad 24-26
Power3 Ratchet 27
Ratchamatic 21, 30-31
Ratchet 28-29, 32
T2 Soft Attach 21
Carbon Fiber 66-67
Classic 37-44
Midrange 42-43
Small Boat 35-41
Wire 44
Cheek
Big Boat 49-51, 59-62
Carbo 22-23, 25-26, 28-30
Classic 35-36, 38, 43-44
Element 49-51
ESP 61
Ratchet 28, 30
Clew Block Assembly 22
Crossover 58
Cruising ESP 61, 78
Deck Organizers 61
Sheaves 78
Stainless Steel 61
Dinghy 39
Doubles 21-22, 24-26, 31, 35-36,
..... 38-39, 41, 43, 49-51, 54-56, 59, 64
Electric Footblock..... 60
Element 48-51
Exit Blocks 34-36, 39-40, 44
Fiddles
Big Boat 49-51, 55, 61
Carbo 32
Classic 36, 43
Cruising ESP 61
Element 49-51
Midrange Classic..... 43
Small Boat Classic..... 36
Fine-Tune Systems 41, 262-264
Fixed-Head 22-23, 35-36, 38
Fixed-Lead 38, 190
FlatWinder..... 60
Flip-Flop 33, 64
Fly Blocks..... 19
Footblocks
Black Magic 59
Cruising ESP 61
Electric 60
Element 49-51
Lock-Off..... 50-51, 59, 61
Stainless Steel 61-62
Forkhead
16 mm 35
Micro 36
GP Catamaran Ceramic Mainsheet System...
..... 41
Grand Prix..... 41, 66-67
Gross-Trim/Fine-Tune Systems... 41, 262-264

Halyard Lead 59, 61-64
Hexa-Cat Bases 40
Hexaratchets 21, 27-33, 40, 43
Hook-In Halyard 35
HTE Ratchamatic 27
Lockoff Blocks
Black Magic Footblocks 59
Cruising ESP Footblocks 61
Element Footblocks 50-51
Loop..... 19, 21, 54-57, 65-67
Low-load Black Magic Air Blocks..... 54-55
Megayacht 62
Mastbase Lead 59, 61-64
Mastcollar 59, 61-62
Micro 36
Midrange..... 42-43
Optimist Halyard 35
Over-the-Top 64
Padeye Blocks 61
Pivoting Lead Block 22, 24
Power3 Ratchets..... 27
Protexit Blocks 34
Quadruples 24-26
Radial Vang..... 107
Ratchets
40 mm Carbo 21, 28-29
57 mm Carbo 21, 27-33
75 mm Carbo 27-28, 30-33
Cheek 28, 30
Doubles 31
Fiddles 32
Flip-Flop..... 33
Hexa-Cat Bases 40
Little Hexa-Cat Bases 40
Midrange Hexaratchet 43
Ratchamatic..... 21, 27, 30-31, 33
Soft-Attach 21
T2 21
Triples 29, 31, 43
Running Backstay
Air Runners 58
Covers 58
Small Boat 18-41, 44
16 mm 35
Carbo Air Blocks..... 20-32
Cheek 22-23, 25, 28, 30, 35-36, 38, 44
Classic 37-41, 44
Deck Organizers 82
Exit 34-36, 39-40, 44
Fiddle 32, 36
Fly 19
HTE Ratchamatic 27
Micro 36
Pivoting Lead Block 22, 24
Power3 Ratchet 27
Protexit 34
Ratchet 21, 27-33, 40
Soft-Attach 19, 21
Swivel 22-32, 35-36, 38, 40-41
Through-Deck 34-36, 39-40, 44
Traveler 21, 22-23
Upright Lead 36, 39-40
V-Jam 36
Wire 38-39, 44
Snatch 65

Index

BLOCKS (continued)

Soft Attach	19, 21, 54-57, 65-67
Black Magic.....	54-57
Carbo.....	21
Fly.....	19
High-load Snatch.....	65
Ratchamatic.....	21
V.....	66-67
Spreacher.....	55
Spriddle.....	55
Stainless Steel	
16 mm.....	35
Big Boat.....	61-62
Cruising ESP.....	61
Micro.....	36
Stand-Up.....	62
Wire.....	44, 107
Stand-Up.....	22-23, 49-51, 54-57, 62
Swivel.....	22-32, 35-36, 38, 40-41, 43, 49-51, 54-57, 61-62
T2 Soft-Attach	21
Ratchets.....	21
Singles.....	21
Teardrop.....	59, 61-63
Through-Deck.....	34-36, 39-40, 44
Traveler.....	21-23, 36
Triples.....	22, 24-26, 29, 31, 35-36, 38, 43, 49-51, 54
Triples with Ratchets & Cams	
Carbo.....	29, 31
Midrange.....	43
Trunnion Snatch Blocks.....	65
Turning Blocks.....	59
Two-Speed Mainsheets.....	41, 264
Upright Leads.....	36, 38-40
V Block.....	66-67
V-Jam.....	36
Vang Block, Radial Traveler.....	107
Wire.....	44, 107
Wire Bullets.....	38-39

C

Cam Cleat Adapter Plate.....	73-74
Cam Cleats	70-72
Aluminum.....	70-72
Carbo.....	70-72
Stainless Steel.....	70-72
Carbo Blocks (see "BLOCKS")	
Carbo OneTouch Locking Winch Handle.....	220
Carbo Racing Foil.....	156
Carbon Winches (see "WINCHES")	
Car Controls.....	106, 111, 117-118
Cars (see "TRAVELERS")	
Chafe Guard, Carbo Racing Foil.....	156
Circuit Breakers.....	206
Complementary Hardware.....	69-93
Control Blocks, Traveler.....	103, 112, 119
Control Boxes, Electric Winch.....	206
Couplers.....	107, 119
Crossbow Pivoting Jib Traveler.....	97
Curved Track.....	127
Custom Products.....	62, 64, 90, 93, 121, 123-126, 129, 144-152
Cylinders, Hydraulic.....	230-235, 237-239

D

Deck Organizers	
Big Boat.....	61, 83
Cruising ESP.....	61
Midrange.....	82
Small Boat.....	82
Stainless Steel.....	61
Digital System Switch.....	207
Dinghy	
Blocks.....	19-41
Clew Hook.....	77
Jib Leads.....	96
Distributors.....	294-295
DN Adapter.....	76
Drilling Guide.....	274

E

Electric Winches.....	195, 199-201, 203, 205, 208-212
End Controls, Self-Tacking Jibs.....	111
End Controls, Traveler.....	106, 111, 117-118
Endstops.....	102, 104, 109, 115, 125-126, 128, 130-131
Extreme Angle Fairlead.....	72-74
Eyestraps.....	73-74, 88

F

Fairleads.....	72-74, 77, 88, 92
Fast Release Fairleads.....	72-74
Filters, Hydraulic.....	249
Fine-Tune Systems.....	41, 262-264
Flairleads.....	73-74
Foil, Carbo Racing.....	156
Folding Padeyes.....	89
Formulas, Load.....	279
Furling	157-190
Block, Stanchion Mount.....	76, 189-190
Electric.....	180-182
ESP.....	176-179
Gennaker.....	159-163, 165
Hydraulic.....	184-188
Lead Block Kits.....	189
Leg Kits, ESP.....	177-179
MKIV Jib Reefing & Furling.....	168-175
Powered Furling.....	180-188
Reflex Free Flying Asymmetric.....	160-163, 165
Reflex Free Flying Code Zero.....	164-165
Small Boat.....	157-159
Small Boat Underdeck.....	157
Snap Shackles.....	190
Staysail.....	159

Systems

Unit 0 (ESP).....	178
Unit 0 (MKIV).....	170
Unit 0 (MKIV Underdeck).....	174
Unit 1 (ESP).....	178
Unit 1 (MKIV).....	170
Unit 1 (MKIV Underdeck).....	174
Unit 1 (Reflex Asymmetric).....	163
Unit 1 (Reflex Code Zero).....	164
Unit 2 (ESP).....	179
Unit 2 (MKIV).....	171
Unit 2 (MKIV Underdeck).....	175
Unit 2 (Reflex Asymmetric).....	163
Unit 2 (Reflex Code Zero).....	164
Unit 3 (ESP).....	179

Unit 3 (MKIV).....	171
Unit 3 (MKIV Underdeck).....	175
Unit 3 (Reflex).....	165
Unit 4 (MKIV).....	171
Underdeck.....	157, 172-175

G

Gennaker Furling.....	159-163, 165
Genoa Lead Cars (see "TRAVELERS")	
Grand Prix Jib Fairleads.....	92
Grease, Winch.....	222
Gross-Trim/Fine-Tune Systems.....	41, 262-264

H

Halyard Restrainers.....	190
Halyard Sheaves.....	81
Halyard Tensioner.....	93
Hand Hold.....	77
Handles, Winch.....	220-221
Hose Assemblies, Hydraulic.....	250
Hydraulic Furling.....	184-188
Hydraulic Power Units.....	252
Hydraulic Winches.....	195, 199, 203, 205, 209-212

Hydraulics

Accessories.....	249-250
Backstay Adjuster, Integral.....	230
Boom Vangs.....	237-238
Cylinders.....	230-235, 237-239
Cylinder Rod End Blocks.....	236
Double-Pull Cylinders.....	235
Filters.....	249
Grand Prix Cylinders.....	239
Hose Assemblies.....	250
Locking Cylinders.....	233
Manifolds.....	242
Oil.....	249
Power Units.....	252
Pressure Transducers.....	249
Pumps.....	246-247
Reservoirs.....	248
Through-Deck Gland.....	250
Valves.....	240-243
Valve Panels.....	240-241, 243-245
Vang Cylinders.....	237-238

J

Jib Leads.....	96, 108, 113-114, 121, 125-126, 129
Jib Reefing and Furling Systems (see "FURLING")	

K

Kits

Cam Fairlead.....	72-74
Cam Wedges.....	73-74
Furling Lead Block.....	189
Gross-Trim/Fine-Tune.....	41
Lazy Jacks.....	154
Sail Chafe Protectors.....	77
Small Boat Furling.....	159
Traveler.....	107, 112, 119
Winch Service.....	222

L

Lazy Jacks.....	154
Lead Rings.....	91
Line-Shedding Endstop.....	102, 104



Index

Loading Formulas 279
LOUPS Soft-Attachments 85
Luff Slider Car 136, 138, 140

M

Mainsail, Luff Cars 136, 138, 140, 142,
..... 146, 148, 150
Mainsail Outhaul Car 154
Mainsail Reefing Systems 272
Mainsheet Systems Drawings 262-264
Maintenance 258
Manifolds, Hydraulic 240-243
Mastbase Blocks 59, 61-63
Masthead Sheaves 78, 81
Metric Conversions 274
McLube® Hullkote™ Speed Polish 254
McLube® One-Drop™ Ball Bearing Conditioner
..... 254
McLube® Sailkote™ Dry Lubricant 254
McLube® Antifoul Alternative™ Polish 254
Micro Cam 70-72
Micro Cam X-Treme Angle Fairlead 72-74
Micro Carbo-Cam Base w/Bullseye 75

O

Oil, Hydraulic 249
Outhaul Systems Drawings 266

P

Padeyes 89-90
Pinstops 96, 106, 108, 111, 113-114,
..... 117-118, 121, 125-126, 129-131
Pinstop Track 96, 104, 109, 115,
..... 125-126, 128, 130-131
Power Units, Hydraulic 252
Powered Furling 180-182, 184-188
Prefeeder 77, 156, 190
Pressure Transducers, Hydraulic 249
Pumps, Hydraulic 246-247

R

Racing Winches (see "WINCHES")
Ratchet Blocks (see "BLOCKS")
Reefing and Furling Systems 166-190
Reference Pages 16-17, 255-279
Reflex Furling 160-165
Reservoirs, Hydraulic 248
Rigging Breaking Loads 278
Rings, Lead 91
Riser, Cam 73-74
Riser, Traveler Track 109, 115
Rondo, Sail Chafe Protector 77

S

Safety Information 256
Sail Chafe Protectors 77

Selection/Ordering Information

Asymmetric Reflex Furling 162
Battcar Systems 133
Big Boat Blocks 46-47
Code Zero Reflex Furling 164
Hydraulics 234, 243, 251
Jib Reefing & Furling 166
Midrange Classic Blocks 42
Travelers 98-99
Winches 193
Self-Tacking Jib Controls 111
Self-Tacking Jib Systems 97, 273

Shackles

Bow 86-87
Captive Halyard 86-87
D Forged 86-87
D High-Resistance 86-87
Large Open 86-87
LOUPS Soft-Attachments 85
Shallow Bow 86-87
Snap 86-87, 190
Spectra®/Dyneema® Braid 85
Stainless Steel 86-87
Stamped 86-87
Twist 86-87
U-Adaptor 86-87

Sheaves

Big Boat 79-80
Cruising ESP 78
Halyard 78, 81
High-Load 80-81
Midrange 78
Self-Contained 78
Small Boat 78
Steering 81
V 80

Slider Battcars 134-136, 138, 140,
..... 144-146, 148, 150

Slider Rods, Genoa Car 125-126
Small Boat Blocks (see "BLOCKS")

Snap Shackles 86-87, 190
Snatch Blocks 65
SnubbAir 192
Soft Shackles 85
Spinnaker Pole Cars 84
Split Backstay Plates 44
Springs 76
Stainless Steel Shackles 86-87
Stanchion Mount Base 76, 190

Stand-Up

Bases 76
Blocks 22-23, 49-51, 54-57, 62
Springs 76
Toggles 107, 112, 119

Staysail Furling 159

Steering Sheaves 81

Stops, Adjustable Pin 96, 106, 111,
..... 117-118, 125-126, 129, 130-131

Switches, Electric/Hydraulic Winch 206-207

Systems Drawings

Backstay 271
Cunningham 267
Genoa Lead Car 259
Gross-Trim/Fine-Tune 262-264
Halyard 270
Mainsail Reefing 272
Mainsheet 262-264
Mastbase Lead Block 268
Outhaul 266
Self-Tacking Jib 273
Spinnaker 269-270
Traveler 260-261
Vang 265

T

T-Track

Battcar Switch System 144-151
Cars 129, 146, 148, 150
Track 128, 147, 149, 151
Trysail Switch System 152

Tangs, Split Backstay 44
Tiller Extensions 93

Track

Battcar 137, 139, 141, 143,
..... 147, 149, 151
Bends 127
Endstops 102, 104, 109, 115,
..... 125-126, 128, 130-131
High-Beam 102, 104, 109, 115
Low-Beam 102, 104, 109, 115,
..... 124-126, 128, 130-131
Pinstop 96, 104, 109, 115,
..... 125-126, 128, 130-131
Retrofit 104, 109, 115
Risers 109, 115
T-Track 128
Traveler 102, 104, 109, 115,
..... 124-126, 130-131
Track Bends 127
Traveler Stand-Up Toggles 107, 112, 119
Traveler Systems Drawings 260-261
Trysail Switch System 152

TRAVELERS

13 mm Micro 102-103

Cars 103
Controls 103
Track 102

22 mm Small Boat 104-107, 122

Cars 105, 122
Controls 106
Track 104

27 mm Midrange 109-112, 122

Cars 110, 122
Controls 111
Track 109

32 mm Big Boat 115-120, 122-124

Cars 116, 122-124
Controls 117-118
Custom 123-124
Track 115, 124

42 mm Mini-Maxi 123-125

Cars 123-125
Controls 125
Custom 123-125
Track 124-125

64 mm Maxi 126

Cars 126
Controls 126
Custom 126
Track 126

Access Rail 130-131

Battcars 133-151

CB (Captive Ball) 84, 97, 100-101, 103,
..... 105, 108, 110, 113-114, 116, 121-122,
..... 130-131, 154

13 mm Micro 103

22 mm Small Boat 105, 122

27 mm Midrange 110, 122

32 mm Big Boat 116, 122

Genoa Leads 108, 113-114, 121

Outhaul 154

Spinnaker Pole Cars 84

Windward Sheeting 122

Crossbow Pivoting Jib Traveler 97

CRX (Captive Roller) 123-124

Custom 123-126, 129

Dual Sheave Catamaran Cars 105

Index

TRAVELERS (continued)

Furling Mainsail Outhaul.....	154
Genoa Leads	108, 113-114, 121, 125-126, 129
Adjustable.....	108, 113-114, 121
CB (Captive Ball).....	108, 113-114, 121
Custom.....	121, 125-126, 129
Pinstop108, 113-114, 121, 125-126, 129	
Systems Drawings.....	259
T-Track.....	128
Track Slides.....	129
Kits.....	107, 112, 119
Loop Cars.....	103, 105, 110, 116, 123-124
Mainsheet.....	103, 105, 110, 116, 122-126
Radial Vang.....	105, 107
Replacement Kits.....	107, 112, 119
Riser, Traveler Track.....	109, 115
Roller (GRX)	123-124
Cars.....	123-124
Custom.....	123-124
Track.....	124
Self-Tacking Jib Controls.....	97, 111
Soft-Attachment Cars.....	103, 105, 110, 116, 123-124
Spinnaker.....	84
Track.....	96-97, 102, 104, 109, 115, 124-126, 130-131
Vang Car.....	105, 107
Windward Sheeting.....	122

U

U-Adaptors.....	86-87
Underdeck Furling.....	157, 172-175
Use Charts.....	42, 46-47, 98-99, 133, 162, 164, 166, 193, 251

V

V Sheaves.....	80
Valves, Hydraulic.....	240-243
Vang, Hydraulic.....	237-238
Vang System Drawings.....	265
Vang Traveler Car.....	105, 107

W

Warranty.....	255-256
Wedges, Cam.....	73-74
Wire Sheaves.....	78, 81

WINCHES

Air Winches.....	217
Captive Reel Winches.....	223-227
Carbon Winches	213-219
Air winches.....	217
Grand Prix.....	213-217
Pedestals/Accessories.....	218-219
Self-Tailing.....	214-217
Top-Cleating.....	214-216
Wide-Body.....	214-217
CLR Mooring Winches.....	208
Digital System Switch.....	207
Drive Components, Pedestal.....	219
Dual-Function Control Box.....	206
Electric/Hydraulic Components.....	206-207
Grand Prix.....	213-217

Handles	220-221
Carbo OneTouch Locking.....	220
Winch Handle.....	220
SpeedGrip.....	220-221
Standard.....	221

Megayacht	209-212
All-Chrome.....	212
Aluminum.....	209, 212
Bronze.....	211-212
Plain-Top.....	212
Powered.....	209-212
Self-Tailing.....	209-212
Stainless Steel.....	210, 212

Pedestals/Pedestal Accessories	218-219
Disconnects.....	219
Drive Components.....	219
Drive Shafts.....	219
Gear Boxes.....	219
Pedestals.....	218
Spinnaker Retrieval System.....	219
Support Shafts.....	219
Universal Joints.....	219

Performa	202-205
Plain-Top.....	204
Powered.....	203, 205
Quattro.....	204
Self-Tailing.....	202-205

Plain-Top.....	197-198, 204, 211-212
Powered	195, 199-201, 203, 205-212, 223-228

Captive Reel Winches.....	223-227
Circuit Breakers.....	206
CLR Mooring Winches.....	208
Control Boxes.....	206
Electric.....	195, 199-201, 203, 205-212
Hydraulic.....	195, 199, 203, 205, 209-212
Megayacht.....	209-212
Performa.....	203, 205
Racing.....	203, 205, 214-216
Radial Line	195, 199-201
Electric.....	195, 199-201
Hydraulic.....	195, 199
Rewind.....	201
UniPower.....	200
Reel Winches.....	223-227
Switches.....	206-207

Quattro.....	204
Racing.....	202-205, 213-217

Radial Line	194-201
Aluminum.....	196, 200-201
Bronze.....	198, 200-201
Chrome.....	196-197, 200-201
Plain-Top.....	197-198
Powered	195, 199-201
Electric.....	195, 199-201
Hydraulic.....	195, 199
Rewind.....	201
UniPower.....	200
Single-Speed Self-Tailing.....	196-198, 200
Three-Speed Self-Tailing.....	196-199
Two-Speed Self-Tailing.....	196-199, 201
White.....	197, 200-201

Reel Winches, Electric/Hydraulic.....	223-227
Self-Tailing Winches.....	194-205, 209-217
Single-Speed Winches.....	196-199, 200, 204
SnubbAir.....	192
SpeedGrip Winch Handles.....	220-221
Three-Speed Winches.....	196-199, 204-205, 209-216
Two-Speed Winches.....	196-199, 201, 204-205, 209-214, 216

X

X-Treme Angle Fairleads.....	72-74
------------------------------	-------



Index

Part No.	Page No.	Part No.	Page No.	Part No.	Page No.	Part No.	Page No.
001	40	163	159	254	154	345	22
010	76	164	157, 158	263	104, 139	346	22
046	39	165	159	264	104	347	22
047	40	166	38	265	78	348	22
061	76, 190	167	38	274	127	349	22
062	77	168	38	275	127	350	22
071	76	169	38	276	127	352	22
072	86, 87	170	40	277	78	353	22
073.PAIR	88	173	104	280	72	365	72
074	88	174	104	281.PAIR	73, 88	368	35
077	76	175	107	282.PAIR	73, 88	369	76
082	38	176	275	283	73	370	76
083	38	177	275, 276, 277	285	77	371	22
084	38	183	38	286	127	373.6	104
085	38	193	40	287	39	373.12	104
086	38	197	39	288	39	374.4	104
087	38	201.PAIR	73, 88	289	39	374.6	104
088	39	205	75	292	36	374.12	104
089	39	206	40	293	73	375	73
093	86, 87	207	157, 158	294	73	376	35
096	39	207HP	158	295	73	377	36
097	76	208	159	296	73	379	75
098	38	216	75	297	73	381	22
099	38	220	39	298	73	382	105
100	38	222	39	300	44	383	41
106	39	223	39	301	**44	384	107
108	39	224	36	302	44	385	41
109	38	225	36	303	78	386	41
110	39	226	36	304	44	391	35
111	86, 87	227	36	305	**44	394	77
112	86, 87	228	36	306	44	395	22
113	38	229	36	307	78	396	22
125	38	230	36	308	44	400	41
126	38	231	36	309	**44	401	41
127	38	232	36	310	44	402	75
128	38	233	36	311	78	403	75
129	38	234	36	312	44	404	35
130	38	235	36	313	44	405	35
131	39	237	77	314	44	406	35
134	39	238	75	320	44	407	35
137.PAIR	73, 88	239	75	321	44	408	35
138	86, 87	240	75	326	72	409	35
144	75	241	75	327	72	412	72
145	73	242	36	332	41	415	78
146	38	243	36	339	77	416	35
147	38	244	36	340	22	417	35
150	72	245	36	341	22	419	88
160	78	246.PAIR	86, 87	342	22	421	35
161	78	252	154	343	22	424	73
162	158	253	154	344	22	425	73

*New parts
**Fasteners supplied



Index

Part No.	Page No.	Part No.	Page No.	Part No.	Page No.	Part No.	Page No.
431	*33	483	159	724	83	1556	43
432	35	484	35	725	83	1558	88
433	77	485	127	726	83	1559	43
434	159	486	127	727	81	1560	43
435	159	487	127	752	119	1564	43
436	159	488	127	754	81	1565	43
437	35	489	157	789	127	1566	43
438	73	491	72	790	127	1567	112
442	35	492	273	791	127	1571	43
443	36	493	157	792	127	1574	75
445.PAIR	88	493L	157	793	127	1581	127
446	104	494	73	794	127	1582	127
448	38, 63, 190	495	73	795	127	1584	86, 87
450	96	496	72	884	190	1586	43
451	96	497	72	885	190	1598	86, 87
452P	96	498	72	891	190	1602.8	109
452S	96	499	72	944	190	1602.12	109
453.9.5	96	500	79	945	190	1603	76
453.12	96	518	79	947	77, 190	1605.4	*109
453.15	96	519	79	1134	159	1605.6	*109
453.18	96	520	79	1200	34	1619	109, 141
453.24	96	547	275, 276, 277	1201	34	1621	109
458	72	548	115	1202	34	1622	109
459	72	548ASSY	149	1203	34	1628	122
460	76	550	79	1204	34	1629	122
461	76	562	115	1300	*192	1631	111
462	75	576	127	1301	*192	1632	111
463	86, 87	577	127	1522	109	1633	111
464	157, 158	580	119	1522ASSY	149	1634	76
465	157, 158	603	79	1523	109	1635	109, 122
466	44	627	89, 90	1526	275, 276, 277	1636	109, 122
467	35	629	89, 90	1527	127	1637	122
468	72	639	75	1528	127	1642	111
469	72	648	89, 90	1529	127	1643	112
470	72	657	79	1530	127	1645	84
471	72	661.2.1m	126	1531	127	1646	84
472	72	661.3m	126	1532	127	1647	84
473	72	661.6m	126	1533	78	1648	154
474	72	662	126	1534	78	1649	*111
475	73	664	126	1539	79	1652	111
476	73	688	89	1540	43	1654	112
477	157	689	89	1541	43	1655	112
477L	157	691	81	1542	43	1702	125
478	157	692	81	1544	43	1706.1.5m	125
478L	157	693	81	1545	43	1706.3m	125
478U	157	694	81	1546	43	1706.3.6m	125
479	157	695	81	1548	43	1706.6m	125
480	157	712	81	1549	43	1707	125
481	157	714	81	1550	43	1708	125
482	157, 158	716	81	1555	43	1734	81

*New parts
**Fasteners supplied



Index

Part No.	Page No.	Part No.	Page No.	Part No.	Page No.	Part No.	Page No.
1777	138, 153	2138	28	2609	28	2661	26
1835.2m	128	2139	28	2610	28	2662	26
1835.4m	128	2140	29	2611	28	2663	26
1836	130	2141	29	2612	29	2664	26
1849	109, 115	2142	33	2613	29	2665	26
1867	83	2143	33	2614	**28	2666	26
1878	158	2144	33	2615	25	2667	26
1880	158	2145	33	2616	25	2668	26
1888.2m	128	2146	21	2617	25	2669	26
1888.4m	128	2147	21	2618	25	2670	27, 28
1889	130	2148	21	2619	29	2671	28
1947	119	2149	21	2621	32	2672	**28
1948	119	2150	21	2622	32	2673	32
1949	119	2151	21	2623	32	2674	32
1981	58	2152	21	2624	32	2675	32
1984	58	2153	21	2625	27, 30	2676	32
1986	63	2154	85	2625.HTE	27	2677	26
1987	64	2155	85	2625.RED	30	2678	33
1988	63	2156	24	2626	30	2679	33
1989	64	2157	24	2627	30	2680	27, 30
1990	63	2158	19	2628	30	2681	30
2103	86, 87	2159	21	2629	31	2682	30
2104	86, 87	2160	21, 27	2630	31	2683	30
2105	86, 87	2160.RED	21	2631	25	2684	30
2106	86, 87	2161	19	2632	31	2685	31
2107	86, 87	2162	21	2633	30	2686	31
2108	86, 87	2163	23	2634	31	2687	31
2109	86, 87	2165	27	2636	23	2688	33
2110	86, 87	2165.HTE	27	2637	23	2689	33
2111	86, 87	2166	27	2638	24, 112	2690	31
2112	86, 87	2167	27	2639	24	2691	31
2115	86, 87	2168	27	2640	24	2692	31
2116	86, 87	2168.HTE	27	2641	24	2693	31
2117	86, 87	2169	27	2642	24	2694	31
2118	86, 87	2170	27	2643	24	2695	31
2119	86, 87	2171	19	2644	23	2696	31
2122	86, 87	2172	27	2645	23	2697	31
2123	86, 87	2173	19	2646	23	2698	19
2124	86, 87	2174	*27	2647	23	2700	103
2125	86, 87	2175	*27	2648	23	2701	103
2126	86, 87	2176	*27	2649	23	2702	103
2127	86, 87	2177	*27	2650	23, 112	2703	103
2131	86, 87	2600	25	2652	23	2704	103
2132	86, 87	2601	25	2654	24	2705	103
2133	88	2602	25	2655	32	2706	102, 137
2134	88	2603	25	2656	32	2707.600mm	102, 137
2135	27, 28	2604	25	2657	32	2707.1m	102, 137
2135.RED	28	2605	25	2658	32	2707.1.2m	102, 137
2136	28	2606	25	2659	23	2707.2m	102, 137
2137	**28	2608	28	2660	26	2707.2.5m	102, 137

*New parts
**Fasteners supplied

Index

Part No.	Page No.	Part No.	Page No.	Part No.	Page No.	Part No.	Page No.
2708	275, 277	2747	107	3099	84	3221	59
2709.1m	102	2748	107	3122	64	3222	59
2709.1.2m	102	2749	107	3123	63	3223	59
2709.2m	102	2750	108	3139	85	3224	58
2710	102	2751.600mm	104	3140	85	3225	119
2711	102, 137	2751.1m	104	3141	85	3226	54
2720.600mm	104, 139	2751.1.5m	104	3142	85	3227	54
2720.1m	104, 139	2751.2m	104	3143	85	3228	54
2720.1.2m	104, 139	2751.3.6m	104	3144	85	3229	54
2720.1.5m	104, 139	2752	122	3145	85	3230	55
2720.1.8m	104, 139	2753	105	3146	85	3231	55
2720.2.1m	104, 139	2754	105	3147	85	3232	55
2720.2.5m	104, 139	2754.NW	105	3148	85	3233	55
2720.3m	104, 139	2755	106	3149	85	3234	59
2720.3.6m	104, 139	2756	105	3150	85	3235	59
2720.6m	104, 139	2757	105	3153	115, 143	3236	59
2721.1.2m	104	2757.NW	105	3157	115	3237	59
2721.1.5m	104	2758.950mm.20	97	3158	115	3238	58
2721.1.8m	104	2758.1.1m.20	97	3159.8	115	3239	58
2721.3.6m	104	2758.1.1m.50	97	3159.12	115	3240	59
2722	104	2759	89, 107	3168	117, 118	3241	55
2723	104	2760	78	3169	117, 118	3242	55
2724	104, 139	2761	86, 87	3170	117, 118	3243	55
2725.1m	104	2762	25	3173	117, 118	3244	55
2725.1.2m	104	2763	107	3174	117, 118	3245	56
2725.1.5m	104	2764	107	3176	115, 122	3246	56
2725.1.8m	104	2765	105	3177	115, 122	3247	56
2725.3.6m	104	2766	*105	3178	115, 122	3248	56
2726	105	2800	41	3179	115, 122	3249	59
2726.NW	105	3002	64	3180	122	3250	59
2727	105	3003	64	3188	84	3251	58
2727.NW	105	3004	64	3189	84	3252	58
2728	105	3035	58	3190	119	3253	59
2728.NW	105	3036	58	3192	*63	3254	56
2729	105	3037	58	3194	64	3255	57
2730	105	3038	58	3197	117, 118	3256	57
2731	105	3068	125	3200.3m	124	3257	59
2732	105	3069	125	3202	85	3258	59
2733	105	3071	126	3203	85	3259	58
2734	105	3074	123, 124	3206	89	3260	58
2735	105	3075	123, 124	3207	89	3261	57
2735.NW	105	3076	154	3212	117, 118	3262	57
2736	105	3079.2m	124	3213	117, 118	3263	59
2736.NW	105	3079.3m	124	3214	54	3264	58
2740	106	3080	124	3215	54	3265	58
2741	106	3086.2m	128	3216	54	3266	57
2742	106	3086.3m	128	3217	54	3267	57
2743	106	3096	154	3218	54	3268	57
2745	122	3097	84	3219	54	3269	91
2746	122	3098	84	3220	59	3270	91

*New parts
**Fasteners supplied



Index

Part No.	Page No.	Part No.	Page No.	Part No.	Page No.	Part No.	Page No.
3271	91	3382	*80	3849.2m	141	3895	148
3272	91	3383	*80	3849.6m	141	3896	148
3273	91	3384	*80	3850	141	3897	148
3274	92	3385	*80	3851	141	3922	*150
3275	92	3500.4	*115	3852	140, 153	3923	*150
3276	92	3500.6	*115	3852.NW	140	3924	*150
3277	92	3802	138, 153	3853	143	3926	*150
3278	92	3803	138, 153	3854	143	3928	*152
3279	92	3804	139	3855	143	3929	*150
3280	92	3805	139	3856	140, 153	3930	*150
3281	92	3806	139	3856.NW	140	3931	*150
3282	91	3807	139	3857	140, 153	3932	*150
3283.PAIR	91	3808	139	3858.2m	143	3933	*152
3284.PAIR	91	3809	139	3858.6m	143	3934	*152
3287	88	3810	139	3859	140, 153	3935	*152
3288	88	3811	138, 153	3860	140, 153	3936	*151
3294	67	3811.NW	138	3861	140, 153	3937	*151
3294AL	67	3812	138, 153	3862	140, 153	3938	*151
3295	67	3812.NW	138	3863	140, 153	3939	*151, 152
3295AL	67	3813	136, 153	3863.NW	140	3940	*151, 152
3296	67	3814	136, 153	3864	141	3941	*151, 152
3296AL	67	3815	136, 153	3865	141	3942	*151
3297	67	3816	136, 153	3866	141	3944	*151
3297AL	67	3817	137	3867	142, 153	3945	*142
3299	65	3818	137	3868	142, 153	6050	63
3300	65	3819	137	3869	142, 153	6056	63
3301	65	3820	137	3870	142, 153	6057	63
3302	65	3821	137	3871	142, 153	6062	78
3303	65	3822	137	3872	142, 153	6063	78
3304	117, 118	3823	137	3873	142, 153	6064	78
3355	80	3824	139	3875	143	6065	63
3356	80	3825	139	3876	142, 148	6068	61
3357	80	3826	139	3877	142, 148	6069	61
3358	80	3827	138, 153	3878.2m	139	6070	61
3362AL	67	3828	138, 153	3878.6m	139	6072	61
3363AL	67	3829	138, 153	3879	140	6073	61
3366AL	*66, 67	3829.NW	138	3881	138, 153	6074	61
3367AL	*66, 67	3830	138, 153	3882	138, 153	6076	61
3368AL	*66, 67	3830.NW	138	3883	138, 153	6079	61
3369AL	*66, 67	3831	138, 153	3884	149	6080	61
3370AL	*66, 67	3833	140, 153	3885	149	6081	61
3371AL	*66, 67	3834	140, 153	3886	149	6087	61
3372AL	*66, 67	3835	140, 153	3887	149	6089	61
3375	*80	3836	140, 153	3888	149	6095	63
3376	*80	3837	137	3889	153	6096	63
3377	*80	3844	141	3890	142, 153	6097	63
3378	*80	3845	141	3891	142, 153	6098	63
3379	*80	3846	141	3892	*146	6107	63
3380	*80	3847	141	3893	*140, 153	6220	*50
3381	*80	3848	141	3894	148	6221	*51

*New parts
**Fasteners supplied

Index

Part No.	Page No.	Part No.	Page No.	Part No.	Page No.	Part No.	Page No.
6230	49	7001.12m	156	7322.10	179	7361.10	164
6231	49	7001.16m	156	7322.20 5/8	167, 179	7362.10	164
6232	49	7001.20m	156	7322.20 3/4	167, 179	7363.10	165
6233	49	7001.30	156	7322.21 5/8	167, 179	7367	165
6234	49	7002.16m	156	7322.21 3/4	167, 179	7371	163, 164
6235	49	7002.20m	156	7322.22 5/8	167, 179	7371.SPOOL	163, 164
6236	49	7002.24m	156	7322.22 3/4	167, 179	7372	163, 164
6237	49	7002.30	156	7322.30	179	7372.SPOOL	163, 164
6238	49	7003.24m	156	7322.31	179	7373	165
6239	49	7003.28m	156	7323.10	179	7373.SPOOL	165
6240	49	7006	156, 190	7323.20 7/8	167, 179	7401	189
6241	49	7100.24	93	7323.20 1	167, 179	7402	189
6242	49	7100.30	93	7323.21 7/8	167, 179	7403	189
6243	49	7100.33	93	7323.21 1	167, 179	7404	189
6250	*49	7100.36	93	7323.22 7/8	167, 179	7405	189
6251	*49	7100.42	93	7323.22 1	167, 179	7406	182
6260	50	7100.48	93	7323.30	179	7407	189
6261	50	7101	93	7323.31	179	7408	190
6262	50	7102	93	7351.10.16m	163	7410.10	170
6263	50	7301	190	7351.10.18m	163	7410.11	174
6264	50	7302	190	7351.10.20m	163	7410.20 5/16	167, 170
6265	50	7303	190	7351.20	164	7410.20 3/8	167, 170
6266	50	7304	190	7351.21	163, 164	7410.20 7/16	167, 170
6267	50	7311.20 1/2	167, 170	7351.22	163	7410.30	170, 174
6268	50	7311.20 5/8	167, 170	7351.26	163	7410.31	170, 174
6269	50	7311.21 1/2	167, 170	7351.27	164	7411.10	170
6270	50	7311.21 5/8	167, 170	7351.28	163, 164	7411.11 1/2	174
6271	50	7312.20 5/8	167, 171	7352.10.20m	163	7411.20 1/2	167, 170
6272	50	7312.20 3/4	167, 171	7352.10.23m	163	7411.30	170, 174
6273	50	7312.21 5/8	167, 171	7352.10.25m	163	7411.31	170, 174
6274	50	7312.21 3/4	167, 171	7352.20	164	7412.10	171
6275	50	7312.22 5/8	167, 182	7352.21	163, 164	7412.11 5/8	175
6276	50	7313.21 3/4	167, 171	7352.22	163	7412.13 12V	182
6277	50	7313.21 7/8	167, 171	7352.26	163	7412.13 24V	182
6278	*50	7320.10	178	7352.27	164	7412.12V.CONV	182
6280	51	7320.20 5/16	167, 178	7352.28	163, 164	7412.24V.CONV	182
6290	51	7320.20 3/8	167, 178	7353.10.22m	165	7412.20 5/8	167, 171
6291	51	7320.21 5/16	167, 178	7353.10.26m	165	7412.30	171, 175, 182
6292	51	7320.21 3/8	167, 178	7353.20	165	7412.31	171, 175, 182
6293	51	7320.30	178	7353.21	165	7413.10	171
6294	51	7320.31	178	7353.22	165	7413.11 3/4	175
6295	51	7321.10	178	7353.26	165	7413.11 7/8	175
6296	51	7321.20 7/16	167, 178	7353.27	165	7413.13 12V	182
6297	51	7321.20 1/2	167, 178	7353.28	165	7413.13 24V	182
6298	51	7321.21 7/16	167, 178	7355	163, 189	7413.12V.CONV	182
6299	51	7321.21 1/2	167, 178	7356	163, 189	7413.24V.CONV	182
7000.9m	156	7321.22 7/16	167, 178	7357	163, 164	7413.15	186
7000.12m	156	7321.22 1/2	167, 178	7358	163, 164	7413.20 3/4	167, 171
7000.15m	156	7321.30	178	7359	189	7413.20 7/8	167, 171
7000.30	156	7321.31	178	7360	189	7413.22 3/4	167, 182

*New parts
**Fasteners supplied



Index

Part No.	Page No.	Part No.	Page No.	Part No.	Page No.	Part No.	Page No.
7413.22 7/8	167, 182	7429 -48	171, 186, 187	G2747B.HL	113, 114	HC8640	62
7413.25 3/4	186	7430	190	G3237B	121	HC8657	62
7413.25 7/8	186	7431	190	G3247B	121	HC8667	62
7413.30	171, 175, 182, 186	9000	82	G3247B.NW	121	HC8670	62
7413.31	171, 175, 182, 186	9001	82	GT326S	129	HC8673	62
7414.10	171	9002	82	HC6107	90	HC8674	62
7414.15L	186	9003	82	HC7224	90	HC8675	62
7414.15S	186	9005	82	HC7316	148	HC8798	147
7414.20 7/8	167, 171	9006	82	HC7322	148	HC8799	147
7414.20 1	167, 171	9007	82	HC7324	148	HC8800	147
7414.20 1 1/8	167, 171	9008	82	HC7325	148	HC8811	147
7414.25 7/8	186	9050	*86, 87	HC7327	90	HC8879	149, 152
7414.25 1	186	E2200	104	HC7340	90	HC8880	149, 152
7414.25 1 1/8	186	E2230	106	HC7343	90	HC8918	147
7414.30	171, 186	E2250	106	HC7382	149	HC8919	147
7414.31	171	E2700	109, 141	HC7388	90	HC8921	147
7414.31L	186	E2730	111, 114	HC7389	90	HC8932	62
7414.31S	186	E2750	111, 114	HC7391	149, 152	HC9045	148
7415.15L	187	E2750HB	111	HC7403	90	HC9046	148
7415.15M	187	E2756	111	HC7466	149, 152	HC9076	62
7415.15S	187	E3200	115, 124, 143	HC7493	148	HC9077	62
7415.25 1 1/8	187	E3230	117, 118	HC7827	147	HC9078	62
7415.25 1 1/4	187	E3230.HL	117, 118	HC7852	90	HC9081	62
7415.25 X X/X	187	E3250	117, 118	HC7904HL	146	HC9082	62
7415.30	187	E3250.HL	117, 118	HC7905	146	HC9083	62
7415.31L	187	E3250HB	117, 118	HC7905HL	146	HC9086	62
7415.31M	187	E3256	117, 118	HC7906	146	HC9087	62
7415.31S	187	G222B	108	HC7906HL	146	HC9088	62
7416.15L	187	G224B	108	HC8076	148	HC9091	62
7416.15M	187	G226S	108	HC8098	148	HC9092	62
7416.15S	187	G272B	113, 114	HC8099	148	HC9093	62
7416.25 1 1/4	187	G273B	113, 114	HC8125	148	HC9106	147
7416.25 1 3/8	187	G273B.HL	113, 114	HC8147	149	HC9107	147
7416.25 1 9/16	187	G274B	113, 114	HC8148	149	HC9108	147
7416.25 X X/X	187	G274B.HL	113, 114	HC8149	149	HC9503	93
7416.30	187	G276S	113, 114	HC8150	149	HC9504	93
7416.31L	187	G276S.HL	113, 114	HC8207	90	HC9597	147
7416.31M	187	G322B.HL	121	HC8220	149	HC9639	93
7416.31S	187	G323B	121	HC8221	149	HC9702	147
741X.25 X/X	167	G324B	121	HC8222	149	HC9703	147
741X.26 X/X	167	G326S	121	HC8224	90	HC9704	147
7420 -4	170, 178	G326S.HL	121	HC8226	149	HC9733	93
7421 -6	170, 178	G2227B	108	HC8227	149	HC9953	93
7422 -8	170, 178	G2227B.NW	108	HC8230	147	HC9985	62
7423 -10	170, 178	G2247B	108	HC8537	146	HC9986	62
7424 -12	170, 171, 179, 182	G2727B	113, 114	HC8537HL	146	HC9987	62
7425 -17	171, 179, 182	G2737B	113, 114	HC8631	62	HC9990	62
7426 -22	171, 179, 182, 186	G2737B.HL	113, 114	HC8633	62	HC10041	62
7427 -30	171, 179, 182, 186	G2747B	113, 114	HC8635	62	HC10060	149
7428 -40	171, 179, 186	G2747B.NW	114	HC8639	62	HC10066	125

*New parts
**Fasteners supplied

Index

Part No.	Page No.	Part No.	Page No.	Part No.	Page No.	Part No.	Page No.
HC10417	147	R32.2.4m	115, 143	STANDARD WINCHES			
HC11662	149	R32.3m	115, 143	Performa			
HC11663	149	R32.3.6m	115, 143	20STP	204	46.2STC	196
HFG233	178	R32.6m	115, 143	20.2PTBBB	198	46.2STCCC	197
HFG235	179	R32HB.1.5m	115	46.2STCW	197	50.2STA	196
HFG594	178	R32HB.1.8m	115	20.2PTCCC	197	50.2STBBB	198
HSB534	*33	R32HB.2.5m	115	20.2PTP	204	50.2STC	196
HSB538	*75	R32HB.3.6m	115	35.2PTBBB	198	50.2STCCC	197
IN1642	131	R32HB.4.5m	115	35.2PTCCC	197	50.2STCW	197
IN1642.CLEAR	130, 131	T2701B	110	35.2PTP	204	60.2STA	196
IN1643.3m	131	T2701B.NW	110	40STQP	204	60.2STBBB	198
IN1643.3m.CLR	130, 131	T2701B.HL	110	40.2STP	198	60.2STC	196
IN1643.3.6m	131	T2701B.HL.NW	110	40.2PTBBB	198	60.2STCCC	197
IN1643.3.6m.CLR	130, 131	T2703B	110	40.2PTCCC	197	60.2STCW	197
IN1643.6m	131	T2703B.HL	110	40.2PTP	204	60.3STA	196
IN1643.6m.CLR	130, 131	T2704B.HL	110	40.2STP	204	60.3STBBB	198
IN1649	130, 131	T2705B	110	46STQP	204	60.3STC	196
IN1650.3m	131	T2705B.HL	110	46.2PTBBB	198	60.3STCCC	197
IN1650.3m.CLR	130, 131	T2721B	110	46.2PTCCC	197	60.3STCW	197
IN1650.3.6m	131	T2721B.HL	110	46.2PTP	204	70.2STA	196
IN1650.3.6m.CLR	130, 131	T2721B.HL	110	46.2STP	204	70.2STBBB	198
IN1651	130, 131	T2731B	110	50.2PTBBB	198	70.2STC	196
IN9561	131	T2731B.HL	110	50.2PTCCC	197	70.2STCCC	197
IN9561.CLEAR	130, 131	T2741B	110	50.2PTP	204	70.2STCW	197
IN9606	131	T2741B.HL	110	50.2STP	204	70.3STA	196
IN9606.CLEAR	130, 131	T27KIT	112	50.3STP	204	70.3STBBB	198
IN10567	131	T3201B	116	60.2STP	204	70.3STC	196
IN10567.CLEAR	130, 131	T3201B.NW	116	60.3STP	204	70.3STCCC	197
R27.1m	109, 141	T3201B.HL	116	70.2STP	204	70.3STCW	197
R27.1mHDP	*109, 141	T3201B.HL.NW	116	70.3STP	204	80.2STA	196
R27.1.2m	109, 141	T3203B	116	80.2STP	204	80.2STC	196
R27.1.5m	109, 141	T3203B.HL	116	80.3STP	204	80.3STA	196
R27.1.8m	109, 141	T3204B	116	Radial			
R27.2m	109, 141	T3204B.HL	116	15STA	196	80.3STC	196
R27.2.5m	109, 141	T3205B	116	20STA	196	Classic Style	
R27.3m	109, 141	T3205B.HL	116	20STBBB	198	B6A	204
R27.3.6m	109, 141	T3209B	116	20STC	196	B6BBA	198
R27.6m	109, 141	T3209B.HL	116	20STCCC	197	B6CCA	197
R27HB.1m	109	T3221B	116	20STCW	197	B8A	204
R27HB.1.5m	109	T3221B.HL	116	35.2STA	196	B8BBA	198
R27HB.1.8m	109	T3231B	116	35.2STBBB	198	B8CCA	197
R27HB.2.5m	109	T3231B.HL	116	35.2STC	196	ELECTRIC WINCHES	
R27HB.3.6m	109	T3241B	116	35.2STCCC	197	Performa	
R32.1m	115, 143	T3241B.HL	116	40.2STA	196	40.2STEP	205
R32.1mHDP	*115, 143	T32KIT	112, 119	40.2STBBB	198	46.2STEP	205
R32.1.5m	115, 143	T32KIT.HL	119	40.2STC	196	50.2STEP	205
R32.1.8m	115, 143	FW250EA12H	60	40.2STCCC	197	60.2STEP	205
R32.2.1m	115, 143	FW250EA24H	60	40.2STCW	197	60.3STEP	205
		FW500EA12H	60	46.2STA	196	70.2STEP	205
		FW500EA24H	60	46.2STBBB	198	70.3STEP	205
						80.2STEP	205
						80.3STEP	205

*New parts
**Fasteners supplied



Index

Part No.	Page No.	Part No.	Page No.	Part No.	Page No.	Part No.	Page No.
Radial		70.3STHP	205	B10CL	221	HC1040160385BCC	230
40RW	201	80.2STHP	205	B10CSG	221	HC1045160385BCC	230
46RW	201	80.3STHP	205	B10HOT	220	MVP Panels	
60RW	201	Radial		HYDRAULICS			
35.2STE	*199	46.2STH	199	Compact Control Panel			
40.2STE	199	50.2STH	199	HYACXPXB1J	245	Cylinders	
46.2STE	199	60.2STH	199	HYCG	238	HYAMXPGB1J	244
50.2STE	199	60.3STH	199	HYCL	233	HYAMXPGB2J	244
60.2STE	199	70.2STH	199	HYCP	235	HYAMXPGC1J	244
60.3STE	199	70.3STH	199	HYCS	232, 239	HYAMXPGC2J	244
70.2STE	199	80.2STH	199	HYCV	238	HYAMXPGF1J	244
70.3STE	199	80.3STH	199	HYCZ	238	HYAMXPGF2J	244
80.2STE	199	AIR WINCHES *217		Cylinder Blocks and Toggles			
80.3STE	199	CAPTIVE REEL WINCHES		HYCBB16	236	HYASXPGB1J	244
900UPW	200	*224, 225, 226, 227		HYCBB19	236	HYASXPGB2J	244
ELECTRIC COMPONENTS		CARBON FIBER WINCHES		HYCBB22	236	HYASXPGS1J	244
B40PDR	205	*213, 214, 215, 216		HYCBB22	236	HYASXPGS2J	244
B46PDR	205	CLR MOORING WINCHES *208		HYCBD11	236	Pressure Hoses	
B50PDR	205	MEGAYACHT WINCHES		HYCBD13	236	HYZHP471TC-6	250
B60PDR	205	209, 210, 211, 212		HYCBD16	236	HYZHP520N-3	250
B60.3PDR	205	WINCH ACCESSORIES		HYCBD19	236	HYZHP520N-4	250
B70PDR	205	Service Kits		HYCBD22	236	HYZHP520N-6	250
B70.3PDR	205	BK4512	222	HYCBS11	236	HYZHP590-3	250
B80PDR	205	BK4513	222	HYCBS13	236	HYZHT30R9-6	250
B80.3PDR	205	BK4514	222	HYCBS16	236	HYZHT7212-6	250
BRS102/P	206	BK4515	222	HYCBS19	236	Pressure Transducers	
BRS102/S	206	BK4516	222	HYCBS22	236	HYET10N2V5	249
BRS104/P	206	BK4517	222	HYHTEJS11	236	HYET10N4V5	249
DSDBK1	207	BK4518	222	HYHTEJS13	236	HYET1004MA20	249
DSDBK2	207	BK4519	222	HYHTEJS16	236	HYET604MA20	249
DSDBK3	207	BK4521	222	HYHTEJS19	236	Pumps	
DSDSS1	207	Winch Handles		HYHTEJS22	236	HYPM1	246
DSDSS2	207	B8AL	221	HYHTEJS25	236	HYPM2	246
DSDSS3	207	B8AP	221	HYHTEJS29	236	HYPM3-1.1R	246
DSSBK4	207	B8ASG	221	HYHTEJS32	236	HYPM3-1.1S	246
DSSSS4	207	B8ASGLP	221	HYHTEJS35	236	HYPM3MP	246
HCP1717	206	B8BL	221	HYHTEJS38	236	HYPMH6600	245
HCP1718	206	B8CL	221	HYHTEJS44	236	HYPMH6800	245
HCP1719	206	B8CSG	221	Filters			
HCP1720	206	B10ADL	221	HYFAP03S	249	HYPMHC800	245
Dual Function Control Boxes..	206	B10AL	221	HYFAP03TF	249	HYPMHC800S	245
HYDRAULIC WINCHES		B10AP	221	HYFAP03TM	249	HYPMHC1000	245
Performa		B10ASG	221	HYFAT40	249	HYPMHC1000S	245
46.2STHP	205	B10BL	221	HYFAT40J6	249	HYPR212	247
50.2STHP	205	Hydraulic Oil		HYOIL22QUART	249	HYPR212L	247
60.2STHP	205	Integral Backstay Adjusters		Pressure Transducers			
60.3STHP	205	HC1025110345BCC	230	HYET10N2V5	249	HYET10N4V5	249
70.2STHP	205	HC1035130345BCC	230	HYET1004MA20	249	HYET604MA20	249

*New parts
**Fasteners supplied

Index

Part No.	Page No.	Part No.	Page No.	Part No.	Page No.
Reservoirs					
HYRPC02	248	C5280	125	C10075	125
HYRPC03	248	C5754	129	C10232	121
HYRPC04	248	C5900	125	C10413	124
HYRPC06	248	C6361	126	C10419	152
HYRPC08	248	C6779	90	C10539	152
HYRPC10	248	C6795	121	C10720	125
HYRVP02	248	C6924	124	C10741	125
HYRVP04	248	C7152	125	C10747	123, 124
		C7513	125	C10768	90
Through-Deck Gland					
HYZD6-3	250	C7754	129	C10879	141
HYZD6-4	250	C7788	129	C10901	129
HYZD6-6	250	C7842	81	C10913	129
		C8322	64	C10937	126
Valves & Manifolds					
HYKMB	242	C8441	126	C11003	90
HYMSG61	242	C8583	126	C11173	90
HYMSG62	242	C8624	64	C11177	90
HYMSG63	242	C8728	123, 124	C11334	90
HYMSG64	242	C8862	123, 124	C12236	62
HYMSG65	242	C8955	123, 124	C12237	62
HYMSP61	242	C8990	124	C12238	62
HYMSP62	242	C8997	90	C12239	62
HYMSP63	242	C9057	90	C12242	62
HYMSP64	242	C9064	90	C12243	62
HYMSP65	242	C9153	90	C12244	62
HYMZG63	242	C9240	90	C12245	62
HYMZG64	242	C9242	129	C13771	*62
HYMZG65	242	C9340	152	C13911	*62
HYMZG66	242	C9341	152	C14040	*62
HYMZG67	242	C9342	152	C14196	*62
HYMZG68	242	C9368	126	C14207	*62
HYMZG69	242	C9374	90	C14457	*62
HYV1GP	242	C9460	123, 124	C14584	*62
HYV1GT	242	C9492	152	C14696	*62
HYV1GT	242	C9493	152		
HYV1PP	242	C9494	152		
HYV1PT	242	C9511	90		
HYV2GP	242	C9512	90		
HYV2GT	242	C9527	90		
HYV2PP	242	C9543	126		
HYV2PT	242	C9563	123, 124		
HYVDPBF	242	C9577	129		
HYVDSPF	242	C9584	90		
HYVRI	242	C9642	123, 124		
HYVRM	242	C9701	123, 124		
		C9758	90		
		C9760	90		
		C9761	90		
		C9775	90		
		C9815	121		
		C10063	90		
CUSTOM PRODUCTS					
C4219	129				
C4579	81				
C5160	126				
C5231	125				

*New parts
**Fasteners supplied



CORPORATE HEADQUARTERS

Harken Inc., USA

One Harken Way
N15W24983 Bluemound Road
Pewaukee, Wisconsin 53072 USA
T: (262) 691-3320
F: (262) 701-5780
E: harken@harken.com
www.harken.com



USA Sales Offices

Harken East (Trade Only)

19 John Clarke Rd.
Middletown, RI 02842
T: (401) 849-8278
F: (401) 841-5070

Harken Southeast (Trade Only)

Neil Harvey
T: (727) 460-4274
E: neil.harvey@harken.com
Peter Doyle
T: (716) 445-7368
E: peter.doyle@harken.com

Harken West

Rusty Rutherford
T: (949) 877-2727
E: rusty.rutherford@harken.com
Don Whelan
T: (619) 405-1791
E: don.whelan@harken.com

USA Corporate Headquarters and Harken Italy are ISO 9001:2015 Certified.

Harken Italy S.p.A.

Via Marco Biagi, 14
22070 Limido Comasco (CO) Italy
T: (39) 031.3523511
F: (39) 031.3520031
E: info@harken.it
www.harken.it



Argentina

Harken Argentina
Del Arca 59
(B1646AAA)
San Fernando, Buenos Aires
Argentina
T: +54-11-4725-0200
F: +54-11-4746-7561
E: info@harken.com.ar

Austria

Peter Frisch GmbH
Isar-Ring 11,
D-80805 München, Germany
T: (49) 89-365075
F: (49) 89-365078
E: info@frisch.de
www.frisch.de

Brazil

Harken Brazil
Av. Princesa Isabel, 2095, Barra Velha
CEP 11630-000, Ilhabela, SP, Brazil
T: +55 12 3895 8754
F: +55 12 3895-8779
E: brasil@harken.com.br

Canada

Western Marine Company
1494 Powell Street
Vancouver, BC, Canada V5L 5B5
T: (604) 253-7721
T: (800) 663-0600
F: (604) 253-2656
E: sales@westernmarine.com
www.westernmarine.com

Transat Marine
Division of Western Marine
70 Ellis Drive, Unit #1
Barrie, ON L4N 8Z3, Canada
T: (705) 721-0143
T: (800) 565-9561
F: (705) 721-0747
E: info@transatmarine.com
www.transatmarine.com

Caribbean

Budget Marine Antigua
Jolly Harbour Boatyard
Bolans, Antigua
T: 268-462-8753
F: 268-462-7727
E: antigua@budgetmarine.com

Budget Marine Antigua
The Compton Building Dockyard Drive
English Harbour
St Paul's, Antigua
T: 268 562 8443
F: 268 462 7727
E: antigua@budgetmarine.com

Budget Marine Antigua
North Sound Marina
Crabbs Peninsula, Antigua
T: 268-562-8753
F: 268-462-7727
E: antigua@budgetmarine.com

Budget Marine Aruba
Balashi 75-B, P.O. Box 162
Oranjestad, Aruba
T: 297-585-3796
F: 297-585-3798
E: aruba@budgetmarine.com

Budget Marine Bonaire
Kaya Neerlandia 21 Kralendijk,
Bonaire Dutch Caribbean
T: 599-717-3710
F: 599-717-3523
E: bonaire@budgetmarine.com

Budget Marine Curaçao
Caracasbaaiweg 202
Curaçao, Dutch Caribbean
T: 5999-462-7733
F: 5999-462-7755
E: curacao@budgetmarine.com

Budget Marine Grenada
Spice Isle Marina, True Blue Bay
St. George Grenada
T: 473-439-1983
F: 473-439-2037
E: grenada@budgetmarine.com

Budget Marine St. Maarten
Waterfront Road 25B
P.O. Box 434 - Philipsburg
Cole Bay, St. Maarten
Dutch Caribbean
T: 721-544-3134
F: 721-544-4409
E: stmaarten@budgetmarine.com

Budget Marine St. Thomas
6198 Estate Frydenhoj
St. Thomas, VI 00802
U.S. Virgin Islands
T: 340-779-2219
F: 340-714-0466
E: stthomas@budgetmarine.com

Budget Marine Tortola Nanny Cay
Resort Tortola, British Virgin Islands
T: 284-494-6588
F: 284-494-0792
E: tortola@budgetmarine.com

Budget Marine Trinidad
Western Main Road
Chaguaramas Trinidad and Tobago
T: 868-634-2006
F: 868-634-4382
E: trinidad@budgetmarine.com

Richardson's Rigging Services
Box 97, Waterfront Drive
Tortola, British Virgin Islands
T: 284 494-2739
T: 284-499-4774
E: info@richardsonsrigging.com

Czech Republic

Harken Polska Sp. z o.o.
ul. Przasnyska 6A
01-756 Warszawa Poland
T: +48 22 561 93 93
E: polska@harken.pl
www.harken.pl

Chile

Windmade Chile
Las Tranqueras 117, Of. 607B
Las Condes, Santiago, Chile
T: +562 29807079
E: ventas@windmade.cl
www.windmade.cl

China

Sunrise Marineware Limited
12th Floor, Building 2,
Baiwang Mansion, Shahe West Road,
Nanshan District, Shenzhen P.R.China
T: 86-755 86650101
F: 86-755 86593878
E: sales@sunrisemw.com
www.sunrisemw.com

SHANGHAI Far East FRP Boat
Co., Ltd. Room 605, Building 5
No. 898 Xiuwen Rd.
Shanghai, China 201199
T: +86 21-67 28 59 77
F: +86 21-67 28 59 76
www.fareastboats.com

Croatia

Sailing Point d.o.o.
Obala 103,
6320 Portoroz Slovenia
T: +386-5-6778125
Mobile: +386 41 418899
E: info@sailing-point.si
www.sailing-point.si

Cyprus

Ocean Marine Equipment, Ltd.
245 A&B Saint Andrews
Street, (3035),
P.O.Box 51370, (3504),
Limassol, Cyprus
T: +357 25369731
F: +357 25352976
E: info@oceanmarine.com.cy
www.oceanmarine.com.cy

Denmark

Columbus Marine A/S
Egegaardsvej 8
4621 Gadstrup Denmark
T: +45 4619 1166
E: columbus@columbus-marine.dk
www.columbus-marine.dk

Estonia

Sail Tech Oy
Veneentekijäntie 10, FIN-00210
Helsinki, Finland
T: (358) 9 682 4950
E: info@sailtech.fi
www.sailtech.fi

Finland

Sail Tech Oy
Veneentekijäntie 10, FIN-00210
Helsinki, Finland
T: (358) 9 682 4950
E: info@sailtech.fi
www.sailtech.fi

Germany

Peter Frisch GmbH
Isar-Ring 11,
D-80805 München, Germany
T: (49) 89-365075
F: (49) 89-365078
E: info@frisch.de
www.frisch.de

Gibraltar

M. Sheppard & Co. Ltd.
Waterport, Gibraltar
T: 350 200 75148
F: 350 200 42535
E: retail@sheppard.gi
www.sheppard.gi

Greece

Tecrep Marine S.A.
Akti Moutsopoulou 36
Piraeus 185 36, Greece
T: 30 210 4521647
F: 30 210 4184280
E: info@tecrepmarine.gr
www.tecrepmarine.gr



Harken Australia Pty, Ltd.
1B Green Street
Brookvale, N.S.W., 2100,
Australia
T: (61) 2-8978-8666
E: info@harken.com.au
www.harken.com.au



Harken Polska Sp. z o.o.
ul. Przasnyska 6A
01-756 Warszawa, Poland
T: +48 22 561 93 93
E: polska@harken.pl
www.harken.pl



Harken France
ZA Port des Minimes, BP 3064
17032 La Rochelle Cedex 1 France
T: (33) 05.46.44.51.20 F: (33) 05.46.44.25.70
E: info@harken.fr
www.harken.fr



Sweden
Harken Sweden AB Brandstore
Västmannagatan 81b
113 26 Stockholm, Sweden
T: (46) 08 222200 F: (46) 0303 61876
E: harken@harken.se
www.harken.se



Harken New Zealand, Ltd.
158 Beaumont Street
Unit 11, Orams Marine Centre
Westhaven, Auckland, 1010, New Zealand
T: (64) 9-303-3744 F: (64) 9-307-7987
E: info@harken.co.nz
www.harken.co.nz
www.fostersshipchandlery.co.nz



Harken UK, Ltd.
Bearing House, Ampress Lane
Lymington, Hampshire SO41 8LW, England
T: (44) 01590-689122 F: (44) 01590-610274
E: sales@harken.co.uk
www.harken.co.uk

Holland/Belgium
On-Deck B.V.
Leimuiderdijk 478a 2156 MX
Weteringbrug
The Netherlands
T: 31 71 331 3366
F: 31 71 331 3387
E: allhands@on-deck.nl
www.on-deck.nl

Hong Kong
Sunrise Marineware Limited
Unit 1,2/F, Hing Wah Industrial
Building, 18 Hi Yip Street,
Yuen Long NT, Hong Kong
T: +852 6942 7682
E: sales@sunrisemw.com
www.sunrisemw.com

Hungary
Peter Frisch GmbH
Isar-Ring 11, D-80805
München, Germany
T: (49) 89-365075
F: (49) 89-365078
E: info@frisch.de
www.frisch.de

Israel
Yamit Y.S.B. Inc.
Marina Tel-Aviv, P.O.B. 6158
Tel-Aviv 61061, Israel
T: (972) 3-527 1777
F: (972) 3-527 1031
E: office@yamitysb.co.il
www.yamitysb.co.il

Japan
Harken Japan Ltd.
2-42 Nishinomiya Hama
Nishinomiya City Hyogo
Pref.,
Japan 662-0934
T: (81) 798-22-2520
F: (81) 798-22-2521
E: info@harken.jp

Korea
Marine Service Korea
Co.,Ltd.
#537 Sunplaza Officetel
1443 Woo-dong Haeundae-gu,
Busan, Korea 48092
T: +82-51-744-7882
F: +82-51-744-7883
E: totalmarine_korea@naver.com
www.servicemarine.co.kr

Latvia
Regate
7A Matrozhu Str. Kipsala,
Riga, LV-1048, Latvia
T: +371 24873486
E: regate@regate.lv
www.harken.lv

Lithuania
Regate
7A Matrozhu Str. Kipsala,
Riga, LV-1048, Latvia
T: +371 24873486
E: regate@regate.lv
www.harken.lv

Malaysia
Harken Australia
1B Green Street Brookvale,
N.S.W., 2100, Australia
T: (61) 2-8978-8666
E: info@harken.com.au
www.harken.com.au

Malta
D'Agata Marine Ltd.
152 Ta'Xbiex Wharf, Gzira, Malta
T: (356) 21 341533
F: (356) 21 340594
E: info@dagatamarine.com
www.dagatamarine.com

Norway
Harken Sweden AB
Hovdan Poly A/S
Stubberudveien 10
Oslo N-0614, Norway
T: (47) 2314 1260
F: (47) 2314 1261
E: hovdan.poly@online.no

Portugal
Equipyacht S.L.
Paseo Joan de Borbó s/n
Moll de Llevant – Nave Sur 4ª Planta
Port de Barcelona
08039 Barcelona, Spain
T: (34) 932 219 219
F: (34) 932 219 578
E: equipyacht@equipyacht.com
www.equipyacht.com

Singapore
Marintech Marketing (S) Pte. Ltd.
101 Kitchener Road, #02-14
Jalan Besar Plaza
Singapore 208511
T: (65) 62988171
F: (65) 62923869
E: marintech@pacific.net.sg
www.marintech.sg

Slovakia
Harken Polska Sp. z o.o.
ul. Przasnyska 6A
01-756 Warszawa Poland
T: +48 22 561 93 93
E: polska@harken.pl
www.harken.pl

Slovenia
Sailing Point d.o.o.
Obala 103,
6320 Portoroz, Slovenia
T: +386-5-6778125
Mobile: +386 41 418899
E: info@sailing-point.si
www.sailing-point.si

South Africa
Harken South Africa
46 Marine Drive
Paarden Island
Cape Town, 7405, South Africa
T: +27 (0) 21 511 3244
F: +27 (0) 21 511 3249
E: info@harken.co.za
www.harken.co.za

Spain
Equipyacht S.L.
Paseo Joan de Borbó s/n
Moll de Llevant – Nave Sur 4ª Planta
Port de Barcelona
08039 Barcelona, Spain
T: +34 932 219 219
F: +34 932 219 578
E: tienda@equipyacht.com
www.equipyacht.com

Harken ProCare - Palma
Equipyacht Palma
Calle Tetuán 26
07011 - Palma de Mallorca
Illes Balears -Spain
T: +34 932 219 219
E: palma@equipyacht.com

Switzerland
Harken Swiss
Peter Frisch GmbH
Isar-Ring 11, D-80805
München, Germany
T: (49) 89-365075
F: (49) 89-365078
E: info@frisch.de
www.frisch.de

Taiwan
Mercury Marine Supply Co. Ltd.
No. 15, Chongshan, Street
Siaogang District,
Kaohsiung, 812, Taiwan, R.O.C.
T: (886) 7-8133233
F: (886) 7-8133236
E: mms46654@ms16.hinet.net

Sunrise Marineware Limited
Unit 1, 2/F, Hing Wah Industrial Building,
18 Hi Yip Street, Yuen Long NT,
Hong Kong
T: +852 6942 7682
E: sales@sunrisemw.com
www.sunrisemw.com

Thailand
Rolly Tasker Sails (Thailand) Co., Ltd.
84/2 Moo 2, Chaofa Road T. Vichit,
A. Muang Phuket 83000 Thailand
T: (66) (0) 76 521 591
F: (66) (0) 76 521 590
E: chandlery@rollytasker.com
E: masts@rollytasker.com
www.rollytasker.com

Turkey
Denpar Makina San. Ve Tic. A.S
Ozbek Sok No:1 Kavacik
Beykoz Istanbul, Turkey
T: +90 (0) 216 693 35 35
F: +90 (0) 216 693 27 27
E: info@denpar.com
www.denpar.com

Ukraine
Harken Polska Sp. z o.o.
ul. Przasnyska 6A
01-756 Warszawa, Poland
T: +48 22 561 93 93
E: polska@harken.pl
www.harken.pl

Uruguay
Harken Argentina
Del Arca 59
1646 San Fernando
Buenos Aires, Argentina
T: +54 11 4725 0200
F: +54 11 4746 7561
E: info@harken.com.ar



SMALL BOAT BLOCKS

Carbo
Classic
Midrange



BIG BOAT BLOCKS

Element
Black Magic
Stainless Steel



COMPLEMENTARY HARDWARE

Cam Cleats
Deck Organizers
Shackles & Eyestraps



TRAVELERS & GENOA LEADS

CB Captive Ball Cars
CRX Captive Roller Cars



MAINSAIL HANDLING SYSTEMS

AA, A, B, C Battcar Systems
Switch T-Track Battcar Systems
Lazy Jacks



HEADSAIL HANDLING SYSTEMS

MKIV
ESP
Powered



WINCHES

Radial
Performa
Classic



HYDRAULICS

Cylinders
Valves & Manifolds
Power Systems



REFERENCE



INDEX

HARKEN®

www.harken.com
Email: harken@harken.com



0 19765312875618

ENGLISH
4000.2020

© Mike Kern



Reflex Furling System Unit 1

For Cable-less Code Zero Sails

Typical Boat Length 6.7 - 10 m (22' - 32')

Maximum Sail Area 60 m² (650 ft²)

Part No.	Description
7351.10BASE	Drive unit
7351.22	2:1/soft attachment threaded adapter
7351.23	Reflex web-on tack terminal for cable-less code zero
7351.24	Web-on head swivel for cable-less code zero

Reflex Furling System Unit 2

For Cable-less Code Zero Sails

Typical Boat Length 9 - 12 m (30' - 40')

Maximum Sail Area 84 m² (900 ft²)

Part No.	Description
7352.10BASE	Drive unit
7352.22	2:1/soft attachment threaded adapter
7352.23	Reflex web-on tack terminal for cable-less code zero
7352.24	Web-on head swivel for cable-less code zero

Reflex Furling System Unit 3

For Cable-less Code Zero Sails

Typical Boat Length 12 - 16.5 m (39' - 54')

Typical Multihull Length 11 - 15 m (36' - 50')

Maximum Sail Area: Monohull 158 m² (1700 ft²); Multihull 139 m² (1500 ft²)

Part No.	Description
7353.10BASE	Drive unit
7353.22	3:1/soft attachment threaded adapter
7353.23	Reflex web-on tack terminal for cable-less code zero
7353.24	Web-on head swivel for cable-less code zero



7351.24
7352.24
7353.24



7351.23
7352.23
7353.23



7351.22
7352.22
7353.22



7351.10BASE
7352.10BASE
7353.10BASE

